

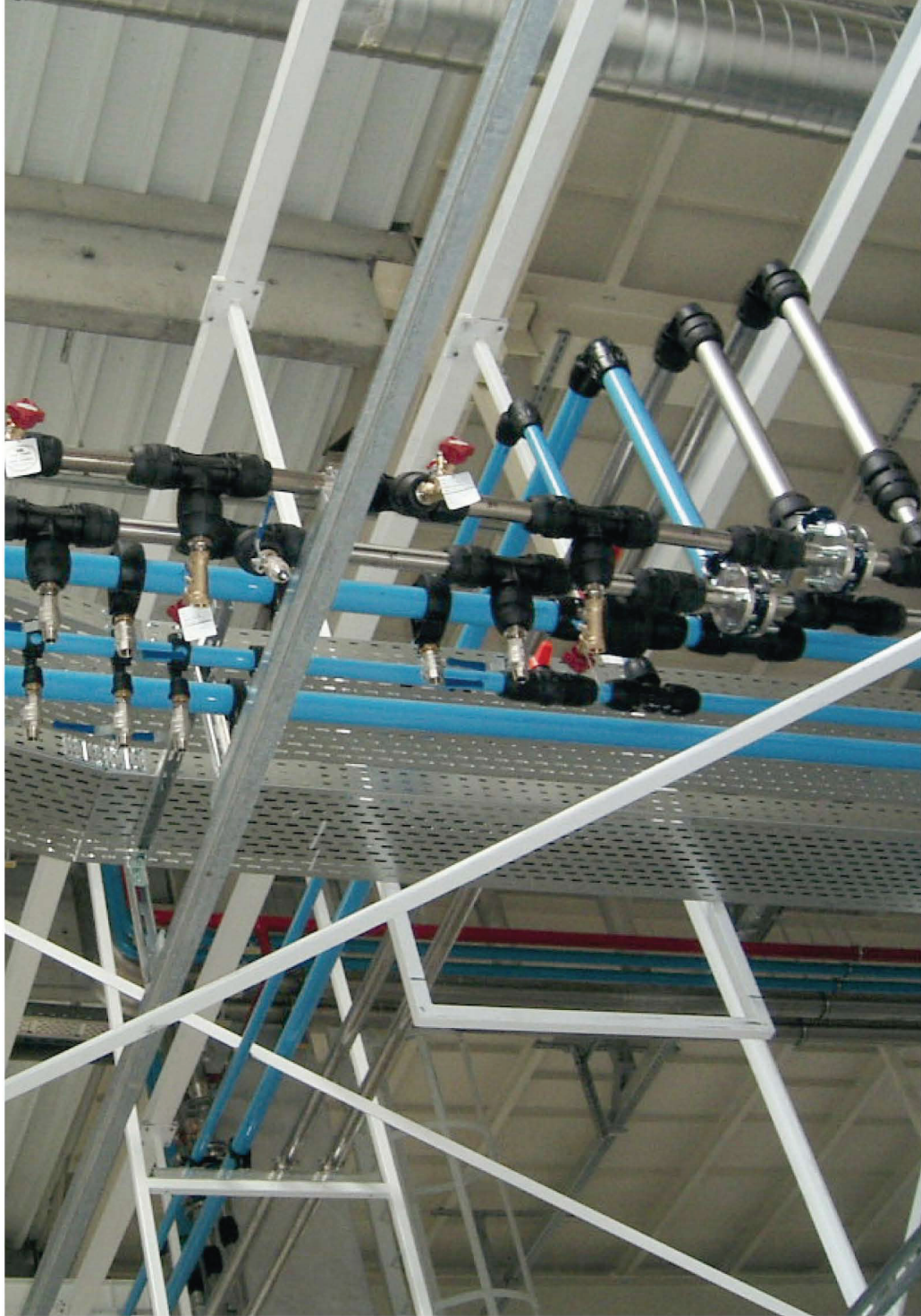

aerospace
 climate control
 electromechanical
 filtration
fluid & gas handling
 hydraulics
pneumatics
 process control
 sealing & shielding



Transair: Advanced pipe systems for Industrials Fluids

Catalogue Compressed Air - Vacuum - Neutral Gases

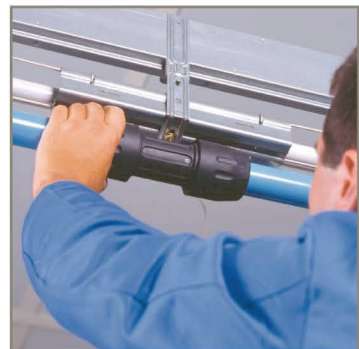

ENGINEERING YOUR SUCCESS.

> Technical specifications

> Fluids

- Compressed air (dry, wet, lubricated)
- Vacuum
- Inert gases (argon, nitrogen)
- Other fluids: please consult us

> Maximum working pressure

13 bar from -20°C to +60°C
16 bar from -20°C to +45°C (except for 168mm)

Maximum working pressure versus operating temperature

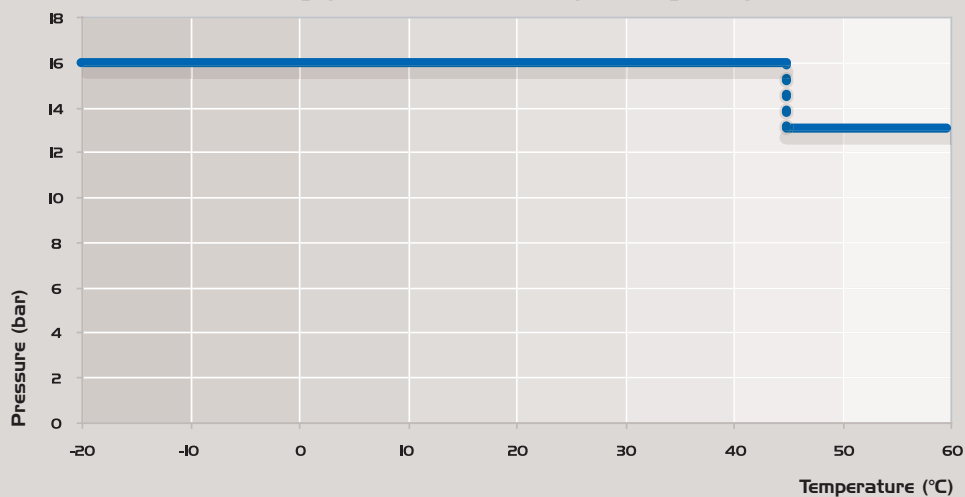

> Vacuum level

98,7 % (13 mbar absolute pressure)

> Working temperature

from -20°C to +60°C

> Storage temperature

from -40°C to +80°C

> Resistance to

- corrosion
- aggressive environments
- mechanical shocks
- thermal variations
- U.V.
- compressor oil carry over

> Environment

Materials are 100% recyclable.
For silicone free applications: please consult us.

> Sizing



Select the TRANSAIR® diameter for your application based on required flow against pressure drop.

Estimated values for: a closed loop network, a pressure of 8 bar with 5% pressure drop. Velocity is not taken into account.

Flow rate			Length										Compressor (Kw)
			164ft	328ft	492ft	984ft	1640ft	2460ft	3280ft	4265ft	5249ft	6561ft	
Nm ³ /h	NI/min	cfm	50m	100m	150m	300m	500m	750m	1000m	1300m	1600m	2000m	
10	167	6	16,5	16,5	16,5	16,5	25	25	25	25	25	25	1
30	500	18	16,5	25	25	25	25	40	40	40	40	40	3
50	833	29	25	25	25	40	40	40	40	40	40	40	5,5
70	1167	41	25	25	25	40	40	40	40	40	40	40	7,5
100	1667	59	25	40	40	40	40	40	40	63	63	63	11
150	2500	88	40	40	40	40	40	63	63	63	63	63	15
250	4167	147	40	40	40	63	63	63	63	63	63	76	25
350	5833	206	40	40	63	63	63	63	63	76	76	76	30
500	8333	294	40	63	63	63	63	76	76	76	100	100	45
750	12500	441	63	63	63	76	76	100	100	100	100	100	75
1000	16667	589	63	63	76	76	100	100	100	100	100	168	90
1250	20833	736	63	76	76	100	100	100	100	168	168	168	110
1500	25000	883	63	76	76	100	100	100	168	168	168	168	132
1750	29167	1030	76	76	100	100	100	168	168	168	168	168	160
2000	33333	1177	76	76	100	100	168	168	168	168	168	168	200
2500	41667	1471	76	100	100	100	168	168	168	168	168	168	250
3000	50000	1766	100	100	100	168	168	168	168	168	168	168	315
3500	58333	2060	100	100	100	168	168	168	168	168	168	168	355
4000	66667	2354	100	100	168	168	168	168	168	168	168*	168*	400
4500	75000	2649	100	100	168	168	168	168	168	168*	168*	168*	450
5000	83333	2943	100	168	168	168	168	168	168	168*	168*	168*	500
5500	91667	3237	100	168	168	168	168	168	168*	168*	168*	168*	550
6000	100000	3531	100	168	168	168	168	168*	168*	168*	168*	168*	600
6500	108333	3826	168	168	168	168	168	168*	168*	168*	168*	168*	650
7000	116667	4120	168	168	168	168	168	168*	168*	168*	168*	168*	700

*Pressure drop >5%

> Example

- Main network length (ring main): 300 metres
- Compressor power: 30 kW
- Required flow rate: 250 Nm³/h (147 cfm)
- Working pressure: 8 bar

• *The most suitable Transair® diameter is: Ø 40.*

To size your air pipework system, you can also use the TRANSAIR® FLOW CALCULATOR. For more information, refer to page 5 of this catalogue.

> Flow rates and pressure drop

Measurements provided by the official French testing body CETIM - Centre Technique des Industries Mecaniques. Charts are based on a 30m straight Transair® line.

Maximum flow rate with 5% pressure drop (To convert to cfm, use a coefficient of 0.588.)

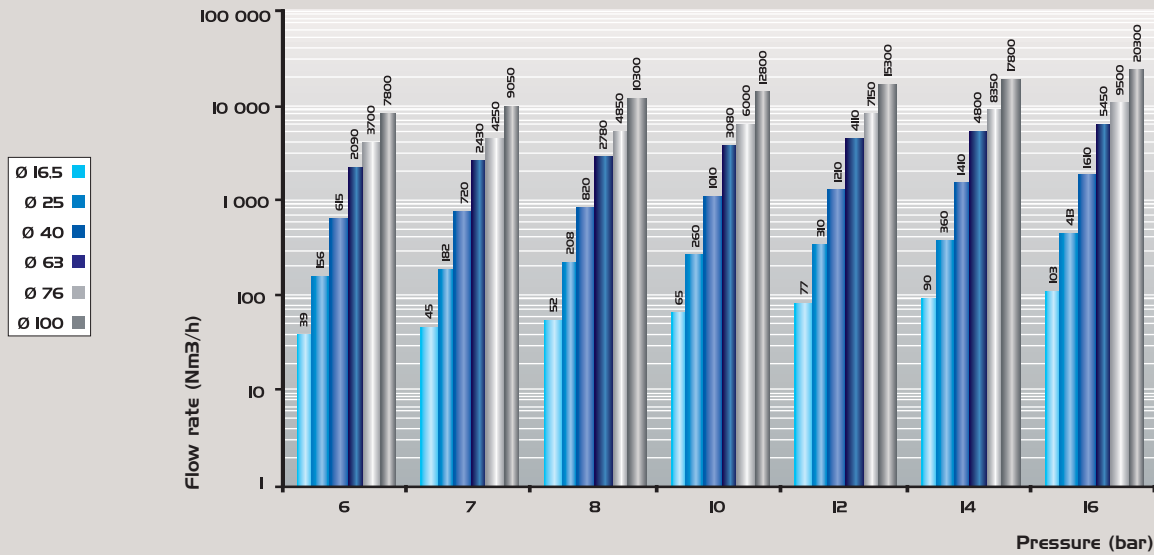

Maximum flow rate with 0.1 bar pressure drop. (To convert to cfm, use a coefficient of 0.588.)

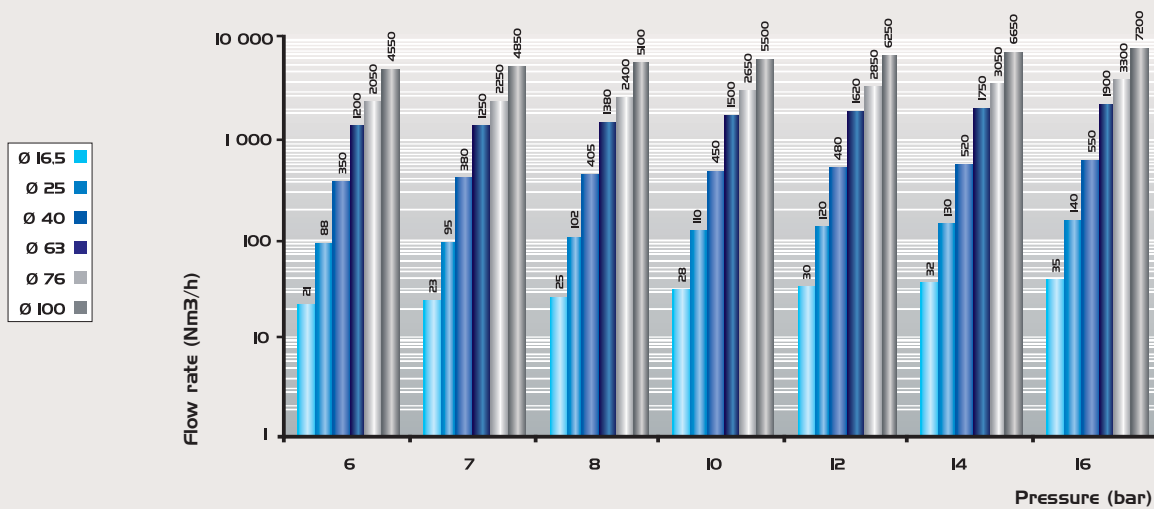

> Transair® Flow Calculator



The TRANSAIR® FLOW CALCULATOR helps you to choose the most suitable diameter for your installation. Enter the flow of your compressor, the system pressure rating and the total equivalent length of the system. Select ring main or straight line layout, enter your preferred unit of calculation and then click for an immediate indication of the most suitable Transair® diameter (with a pressure drop of less than 5%).

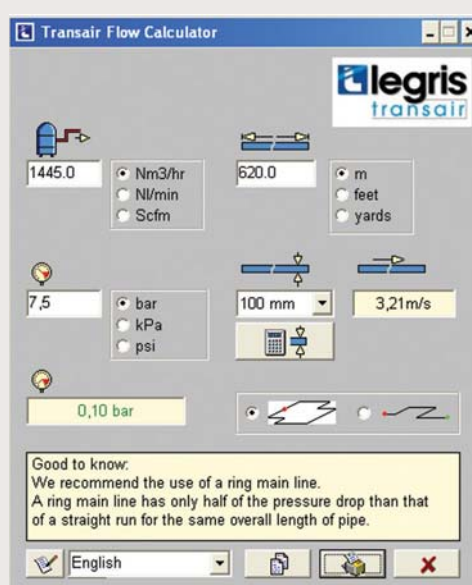

> Example

- > Flow rate: 1 445 Nm³/h (850 cfm) at 7,5 bar (109 psi)
- > Ring main: 545 metres
- > The recommended TRANSAIR® diameter is Ø76mm
(pressure drop of 0,10 bar = less than 5 %)

> Request
download

The new TRANSAIR® FLOW CALCULATOR from our web site :
www.transair.legris.com

> Safety

> Fire resistance

All TRANSAIR® components are non-flammable with no propagation of flame.

- pipe-to-pipe and stud connectors, ball valves and butterfly valves : conform to UL94HB standard
- fixture clips : conform to UL94V-2 standard
- flexible hoses : conform to ISO 8030 norm for compressed air applications, and to EN 12115 norm for vacuum applications
- pipe lacquer finish classified MO

> Electrical conductivity

In areas of potential risk, the earthing and electrical continuity of metallic components are obligatory. The Transair® system can be used in such environments by undertaking the appropriate precautions. For more information, please consult us.

> CE conformity

Transair® conforms to European standard 97/23 CEE - §3.3 (equipment under pressure).



DECLARATION OF CE CONFORMITY Supplied in conformity with the **DIRECTIVE on EQUIPMENT UNDER PRESSURE** **97/23/CEE**

We hereby declare that all Transair® connectors manufactured by LEGRIS S.A. should be considered as piping components which designed according to sound working practice. "Piping includes in particular a pipe or system of pipes, tubing, fittings, expansion joints, hoses, or other pressure-bearing components as appropriate" – of acceptance by the «pressure working group» dated 28/01/1999 and by the GTP Commission dated 27/11/1998.

Products designed according to the code of practice.

Product description: Transair® connectors Ø 16.5 - Ø 25 - Ø 40 - Ø 63 - Ø 76 - Ø 100

Applicable approvals: AFAQ Certificate of Approval, EN ISO 9001

> Material

	Ø 16,5 - Ø 25 - Ø 40	Ø 63		Ø 76 - Ø 100
1003A	lacquered aluminium	lacquered aluminium	TA03	lacquered aluminium
1006A	lacquered aluminium	lacquered aluminium	TA06	lacquered aluminium
1001E air	hose and coating : black SBR reinforcement : synthetic braiding	hose and coating : black SBR reinforcement : synthetic braiding	EW05	seal : EPDM
1001E vacuum	hose and coating : black SBR / NBR reinforcement : spiral steel wire	hose and coating : black SBR / NBR reinforcement : spiral steel wire	FP01	hose and connector: black SBR/NBR reinforcement : spiral steel wire
4002 - 4012	engineering grade plastic	body: engineering grade plastic nut: treated aluminium	RP01	body and pushing ring : engineering grade plastic - seal: NBR
4089 - 4099 - 4230	body: treated brass nut: engineering grade plastic	-	RR01	clamp : treated steel cartridge : engineering grade plastic seal : NBR
4981	body: plated brass seal: PTFE and nitrile	-	RR05	treated brass
6602 - 6604	engineering grade plastic	treated aluminium	RR61	body: iron (EN 1563) - seal : NBR screw : treated stainless steel lining : elastomer
6605	body : treated brass nut : polymer HR / NBR	body : treated brass nut: treated aluminium / NBR	RX02	stainless steel 304
6606	engineering grade plastic	treated aluminium	RX12	stainless steel 304
6612	engineering grade plastic	treated aluminium	RX04	stainless steel 304
6621	treated aluminium	-	RX23	stainless steel 304
6625	engineering grade plastic	treated aluminium	RX24	stainless steel 304
6651	body : treated brass nut: engineering grade plastic	-	RX64	stainless steel 304
6661	body: engineering grade plastic insert : brass	body : engineering grade plastic insert : brass	RX66	stainless steel 304
6662	engineering grade plastic	polymère HR	RX30	stainless steel 304
6666	body : treated aluminium nut: engineering grade plastic	treated aluminium	VR02	body: iron disc and shaft : stainless steel
6676	engineering grade plastic	body : treated aluminium nut : polymer HR	VR03	nickel-plated brass
6680 - 6681	body: treated brass nut: engineering grade plastic	-	Bracket	zinc steel - rubber EPDM
6685 - 6686	treated brass	-	For all silicone free applications : please consult us.	
EA98	body : treated iron ball valve : plated brass	-		
RA69	engineering grade plastic	-		
RA65	body: engineering grade plastic insert : brass	-		
Clip - Spacer	engineering grade plastic	engineering grade plastic		
Adaptor	brass	-		
Fixture accessories	galvanized steel - brass			
Column	anodized aluminium			
Module	aluminium			
Composite coupler	body : polymer HR / Zamac - sleeve : polymer HR - spring and ball bearings : stainless steel - seal : nitrile - probe : treated steel			
Metal coupler	body : anodized duralumin - sleeve: treated nickel-plated steel - spring : stainless steel - seal : nitrile - probe : treated steel, treated brass			
Hose reel	plastic/metal case - fixing : metal			
Blow gun	reinforced polyamide - treated aluminium - insert brass			
Connections accessories	plated brass			
Anti whip-lash strap	steel			

> Transair® Technology

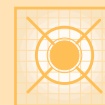

Innovative technology at the heart of TRANSAIR® enables rapid and easy assembly: quick connection of components to the aluminium pipe.

This technology takes into account the specific requirements of each diameter and provides the user with an optimum safety coefficient and easy connection.

- > Ø 16,5
- > Ø 25
- > Ø 40

Pipe-to-pipe and stud connectors in Ø 16,5, Ø 25 and Ø 40 can be immediately connected to Transair® pipe - simply push the pipe into the connector up to the connection mark. The gripping ring of each fitting is then automatically secured and the connection is safe.

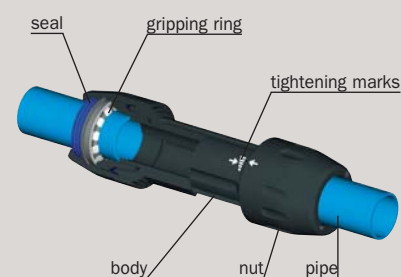

- > Ø 63

Pipe-to-pipe and stud connectors in Ø 63 can be quickly connected to Transair® aluminium pipe by means of a double clamp ring. This secures the connection between the nut and the pipe - tightening of the nuts secures the final assembly.

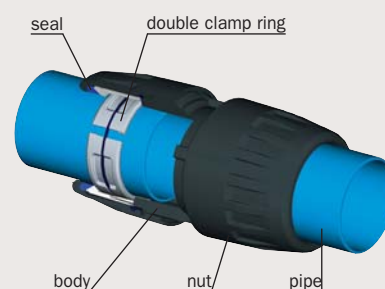

- > Ø 76
- > Ø 100

Pipe-to-pipe and stud connectors in Ø 76 and Ø 100 can be quickly connected to Transair® aluminium pipe. Position the pipes to be connected within the Transair® cartridge and close/tighten the Transair® clamp.

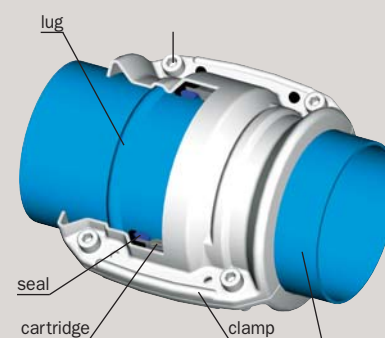

> Services

A number of additional Transair® services help you throughout your projects.

> Project assistance



Understanding, Proximity, Responsiveness. Field support

TRANSAIR® technical-commercial teams are at your disposal to study and help design your air network. In particular, they assist you in your project with :

- Information on the TRANSAIR® products and services,
- Guidance and training on how to assemble the system,
- Advice on “best practice” in order to reduce your consumption of energy,
- Ongoing assistance and follow-up.
- On-site advisory presence at construction and installation locations.

Internally

Our CUSTOMER SERVICE teams will co-ordinate a quick response to your requirements.

> **Commercial service - France & International**

- Product availability
- Order processing and follow-up
- Delivery time-phasing and modification
- Technical information

> **Costing service**

- Advice
- Design software

> Wherever you are in the world, you can contact us :

- by phone
- by fax
- by post
- by e-mail

To find the address of your nearest TRANSAIR® contact, please see the INDEX of this catalogue.

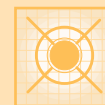

> Transair design software

- Installation sizing
- System layout and drawing
- Shopping list
- Available on CDROM

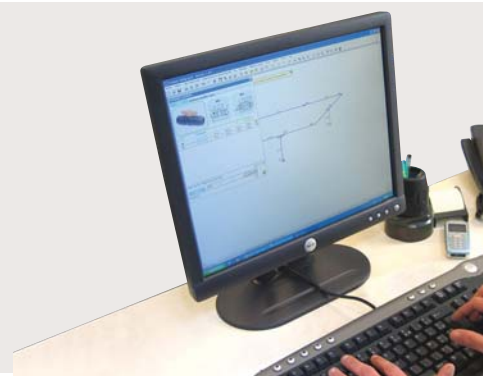

> Web site

- Practical information
- Downloadable literature files: catalogues, information on new products, introductory leaflet, instruction guidelines, newsletter.

www.transair.legris.com



> CAD drawings

All TRANSAIR® CAD drawings are available on a CDROM - in formats DWG, DXF and PS.

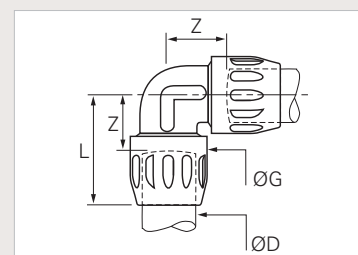

> Specification sheets

Formal technical specifications for the TRANSAIR® system are available in either Word or PDF format and can be directly integrated into your own documents.

ENERGY
SAVINGS

Consistent high quality
internal surface
> CLEAN AIR

Full flow connection and low friction
internal surface of the pipe
> HIGH FLOW RATE PERFORMANCE

Calibrated pipe diameter
> OPTIMUM SEALING

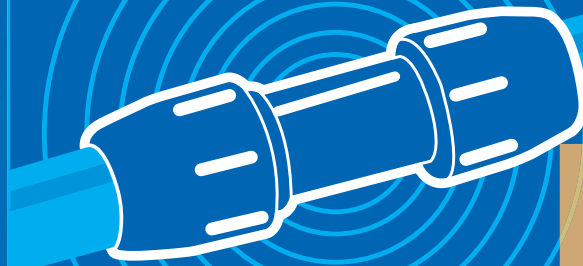

**COMPONENTS
GUARANTEED
FOR
10 YEARS**

SAFETY

> non-flammable
materials

> Products catalogue

	Rigid aluminium pipe	14
	Flexible hose	17
	Pipe-to-pipe and stud connectors	18
	Quick assembly brackets	26
	Wall brackets	30
	Ball valves and butterfly valves	34
	Tools	36
	Fixture accessories	40
	Hose reels - blowgun	44
	Tubes and hoses	45
	Automatic couplers	46
	Connection accessories	50
	FRLs, automatic drains and accessories	54

> Rigid aluminium pipe

- > Clean air
- > Optimum flow rate performance
- > Lightweight
- > QUALICOAT certified surface finish
- > 2 colours : blue (RAL 5012/BS1710), grey (RAL 7001), green (RAL 6029) (other colours : please consult us)
- > Suitable fluids : compressed air, vacuum, nitrogen, argon (other fluids : please consult us)

- > Ø 76 and Ø100 pipe is also available in stainless steel (please ask for details)
- > Max. working pressure :
 - 13 bar from -20°C to +60°C
 - 16 bar from -20°C to +45°C (please consult us for higher temperature requirements)
- > Vacuum : 98,7% (13 mbar absolute pressure)
- > Working temperature : -20°C to +60°C
- > Extruded pipe (conforms to EN 755.2, EN 755.8 and EN 573.3 standards)

Ø
16,5
25
40

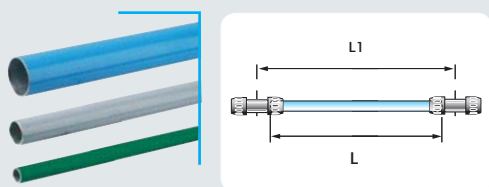

Blue pipe

Transair®	Øout.	Øin	L1 (m)	L (m)
1003A17 04 00	16,5	13	3	2,930
1004A17 04	16,5	13	4,5	4,430
1003A25 04 00	25	22	3	2,903
1006A25 04 00	25	22	6	5,903
1003A40 04 00	40	37	3	2,885
1006A40 04 00	40	37	6	5,885

Grey pipe

Transair®	Øout.	Øin	L1 (m)	L (m)
1003A17 06 00	16,5	13	3	2,930
1003A25 06 00	25	22	3	2,903
1006A25 06 00	25	22	6	5,903
1003A40 06 00	40	37	3	2,885
1006A40 06 00	40	37	6	5,885

Green pipe

Transair®	Øext.	Øint.	L1 (m)	L (m)
1004A17 02	16,5	13	4,5	4,430
1006A25 02 00	25	22	6	5,903
1006A40 02 00	40	37	6	5,885

Sticker for compressed air networks



Sticker for vacuum networks



Ø
63

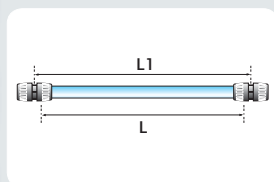
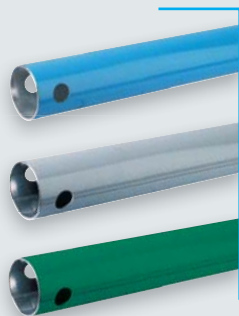

Blue pipe

Transair®	Øout.	Øin	L1 (m)	L (m)
1003A63 04	63	59	3	2,950
1006A63 04	63	59	6	5,950

Grey pipe

Transair®	Øout.	Øin	L1 (m)	L (m)
1003A63 06	63	59	3	2,950
1006A63 06	63	59	6	5,950

Green pipe

Transair®	Øext.	Øint.	L1 (m)	L (m)
1006A63 02	63	59	6	5,950

> Rigid aluminium pipe

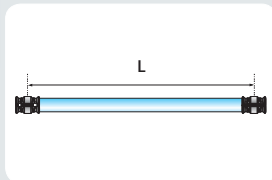
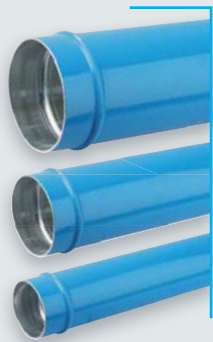

Ø
76
100
168

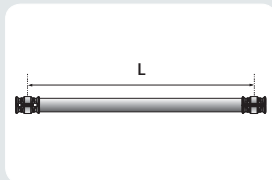
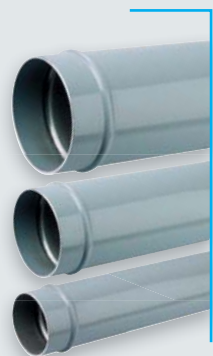

Blue pipe

Transair®	Øout.	Øin	L (m)
TA03 L1 04	76,3	72,3	3,000
TA06 L1 04	76,3	72,3	6,000
TA03 L3 04	101,8	97,2	3,000
TA06 L3 04	101,8	97,2	6,000
TA03 L8 04	168,3	161,3	3,000
TA06 L8 04	168,3	161,3	6,000

Grey pipe

Transair®	Øout.	Øin	L (m)
TA06 L1 06	76,3	72,3	6,000
TA06 L3 06	101,8	97,2	6,000
TA06 L8 06	168,3	161,3	6,000

- > Compressor outlets (absorption of vibration)
- > To bypass obstacles and join different levels
- > Expansion loops
- > Max. working pressure for flexible hose used for compressed air :
 - 13 bar from -20°C to +60°C
 - 16 bar from -20°C to +45°C (please consult us for higher temperature requirements)
- > Max. working pressure of vacuum flexible hose used for compressed air : 10 bar

- > Vacuum : 98,7% (13 mbar absolute pressure)
- > Working temperature : -20°C to +60°C
- > Resistant to mineral and synthetic compressor oils
- > Fire resistant (conforms to ISO 8030 standard for compressed air flexible hose and to EN 12.115 standard for vacuum flexible hose)

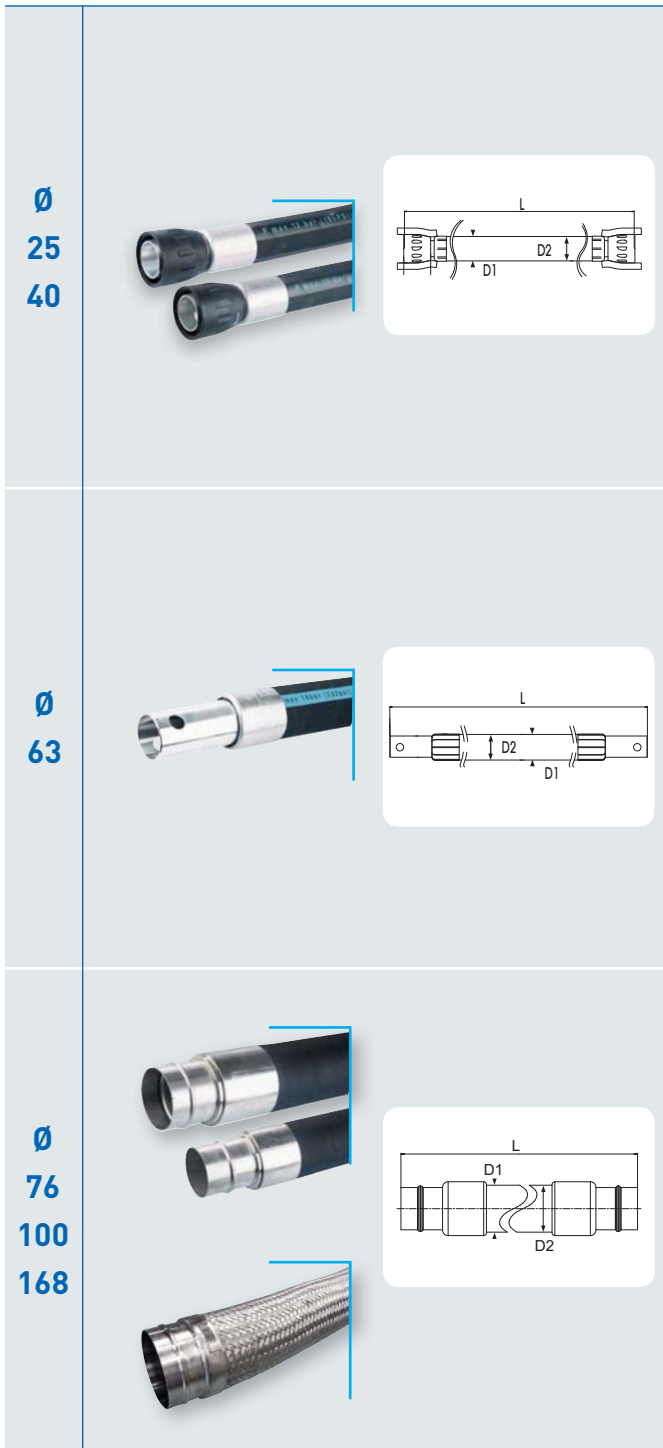

Flexible hose for compressed air networks

Transair®	DI	D2	L (m)	Min. bend radius (mm)	For use with Transair® pipe diameter
1001E25 00 01	38	25	0,570	100	25
1001E25 00 03	38	25	1,500	100	25
1001E25 00 04	38	25	2,000	100	25
1001E40 00 02	54	40	1,150	400	40
1001E40 00 04	54	40	2,000	400	40
1001E40 00 05	54	40	3,000	400	40

Flexible hose for vacuum networks

Transair®	DI	D2	L (m)	Min. bend radius (mm)	For use with Transair® pipe diameter
1001E25V00 01	36	25	0,570	75	25
1001E25V00 03	36	25	1,500	75	25
1001E25V00 04	36	25	2,000	75	25
1001E40V00 07	52	40	0,950	160	40
1001E40V00 04	52	40	2,000	160	40
1001E40V00 05	52	40	3,000	160	40

Flexible hose for compressed air networks

Transair®	DI	D2	L (m)	Min. bend radius (mm)	For use with Transair® pipe diameter
1001E63 00 08	79	63	1,400	300	63
1001E63 00 05	79	63	3,000	650	63
1001E63 00 06	79	63	4,000	650	63

Flexible hose for vacuum networks

Transair®	DI	D2	L (m)	Min. bend radius (mm)	For use with Transair® pipe diameter
1001E63 00 08	79	63	1,400	300	63
1001E63V00 05	76	63	3,000	250	63
1001E63V00 06	76	63	4,000	250	63

Flexible hose for compressed air and vacuum networks

Transair®	DI	D2	L (m)	Min. bend radius (mm)	For use with Transair® pipe diameter
FP01 L1 01	91	75	1,500	350	76
FP01 L1 02	91	75	2,000	350	76
FP01 L3 02	116	100	2,000	450	100
FP01 L3 03	116	100	3,000	450	100

Use 2 connectors RR01 to connect flexible hoses FP01 to Transair® pipe.

Transair®	DI	D2	L (m)	Min. bend radius (mm)	For use with Transair® pipe diameter
FX01 L8 02	168	150	3,200	900	168

Anti whip-lash strap



Prevents whip-lash should Transair® flexible hose be disconnected whilst under pressure.

Conforms to ISO 4414 safety standard.

Anti whip-lash strap includes 2 cables and 4 tensioning points.

6698 99 03 for Ø 25-40-63-76-100.

6698 09 07 for Ø 168 only.

> Pipe-to-pipe and stud connectors

The range of Transair® pipe-to-pipe and stud connectors provides versatility of design and helps to overcome constraints often encountered with the structure of industrial buildings.

> Quick connection

> Full bore design*

> Interchangeable** and reusable

> Non-flammable materials (UL94-HB standard)

*Consistent inner diameter for both pipe and connectors.

**Applicable to Ø 16,5, Ø 25 and Ø 40

Ø
16,5
25
40

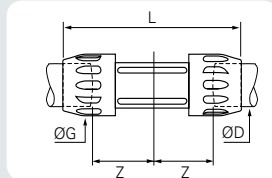

Pipe-to-pipe connector

Transair®	ØD	ØG	L	Z
6606 17 00	16,5	34,0	120,5	33,0
6606 25 00	25	44,5	151,5	48,0
6606 40 00	40	67,0	205,0	57,0

Ø
63

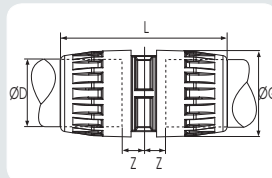

Transair®	ØD	ØG	L	Z
6606 63 00	63	91,0	171,5	25,0

Ø
76
100
168

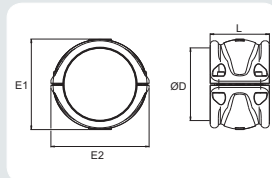

Pipe-to-pipe connector (clamp and cartridge)

Transair®	ØD	L	E1	E2
RR01 L1 00	76	146	103	132
RR01 L3 00	100	146	128	157
RR01 L8 00	168	139	212	230

Ø
25
40

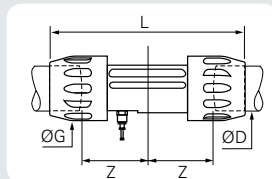

Pipe-to-pipe connector with vent

Transair®	ØD	ØG	L	Z
6676 25 00	25	44,5	151,5	48,0
6676 40 00	40	67,0	205,0	57,0



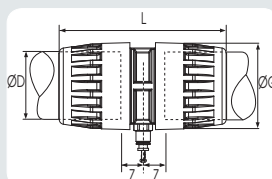





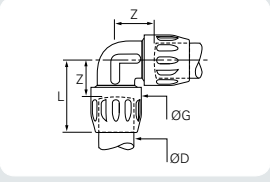

Ø
63

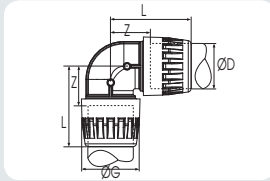

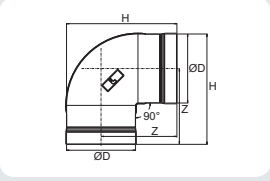
Transair®	ØD	ØG	L	Z
6676 63 00	63	91,0	171,5	25,0

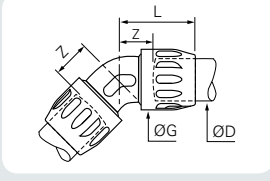
Models supplied with 1/4" threaded fitting and Ø8 mm push-in connection, complete with blanking plug.

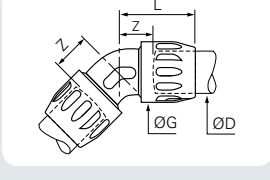
- > Max. working pressure :
 - 13 bar from -20°C to +60°C
 - 16 bar from -20°C to +45°C
 - (please consult us for higher temperature requirements)
- > Vacuum : 98,7% (13 mbar absolute pressure)
- > Working temperature : -20°C to +60°C

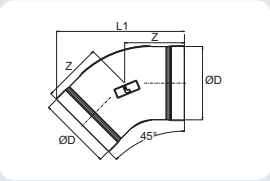
<p>Ø</p> <p>16,5</p> <p>25</p> <p>40</p>			90° elbow																					
			<table border="1"> <thead> <tr> <th>Transair®</th> <th>ØD</th> <th>ØG</th> <th>L</th> <th>Z</th> </tr> </thead> <tbody> <tr> <td>6602 17 00</td> <td>16,5</td> <td>34,0</td> <td>58,0</td> <td>31,0</td> </tr> <tr> <td>6602 25 00</td> <td>25</td> <td>44,5</td> <td>69,5</td> <td>40,0</td> </tr> <tr> <td>6602 40 00</td> <td>40</td> <td>67,0</td> <td>107,0</td> <td>62,0</td> </tr> </tbody> </table>	Transair®	ØD	ØG	L	Z	6602 17 00	16,5	34,0	58,0	31,0	6602 25 00	25	44,5	69,5	40,0	6602 40 00	40	67,0	107,0	62,0	
Transair®	ØD	ØG	L	Z																				
6602 17 00	16,5	34,0	58,0	31,0																				
6602 25 00	25	44,5	69,5	40,0																				
6602 40 00	40	67,0	107,0	62,0																				
<p>Ø</p> <p>63</p>			<table border="1"> <thead> <tr> <th>Transair®</th> <th>ØD</th> <th>ØG</th> <th>L</th> <th>Z</th> </tr> </thead> <tbody> <tr> <td>6602 63 00</td> <td>63</td> <td>91,0</td> <td>124,0</td> <td>61,0</td> </tr> </tbody> </table>		Transair®	ØD	ØG	L	Z	6602 63 00	63	91,0	124,0	61,0										
Transair®	ØD	ØG	L	Z																				
6602 63 00	63	91,0	124,0	61,0																				
<p>Ø</p> <p>76</p> <p>100</p> <p>168</p>			<table border="1"> <thead> <tr> <th>Transair®</th> <th>ØD</th> <th>H</th> <th>Z</th> </tr> </thead> <tbody> <tr> <td>RX02 L1 00</td> <td>76</td> <td>227</td> <td>189</td> </tr> <tr> <td>RX02 L3 00</td> <td>100</td> <td>278</td> <td>221</td> </tr> <tr> <td>RA02 L8 00</td> <td>168</td> <td>269,2</td> <td>185,0</td> </tr> </tbody> </table> <p>Use 2 connectors RR01 to connect 90° elbow RX02 to Transair® pipe.</p>		Transair®	ØD	H	Z	RX02 L1 00	76	227	189	RX02 L3 00	100	278	221	RA02 L8 00	168	269,2	185,0				
Transair®	ØD	H	Z																					
RX02 L1 00	76	227	189																					
RX02 L3 00	100	278	221																					
RA02 L8 00	168	269,2	185,0																					
<p>Ø</p> <p>25</p> <p>40</p>			<table border="1"> <thead> <tr> <th>Transair®</th> <th>ØD</th> <th>ØG</th> <th>L</th> <th>Z</th> </tr> </thead> <tbody> <tr> <td>6612 25 00</td> <td>25</td> <td>44,5</td> <td>61,5</td> <td>32,5</td> </tr> <tr> <td>6612 40 00</td> <td>40</td> <td>67,0</td> <td>94,0</td> <td>45,0</td> </tr> </tbody> </table>		Transair®	ØD	ØG	L	Z	6612 25 00	25	44,5	61,5	32,5	6612 40 00	40	67,0	94,0	45,0					
Transair®	ØD	ØG	L	Z																				
6612 25 00	25	44,5	61,5	32,5																				
6612 40 00	40	67,0	94,0	45,0																				
<p>Ø</p> <p>63</p>			<table border="1"> <thead> <tr> <th>Transair®</th> <th>ØD</th> <th>ØG</th> <th>L</th> <th>Z</th> </tr> </thead> <tbody> <tr> <td>6612 63 00</td> <td>63</td> <td>91,0</td> <td>100,0</td> <td>37,0</td> </tr> </tbody> </table>		Transair®	ØD	ØG	L	Z	6612 63 00	63	91,0	100,0	37,0										
Transair®	ØD	ØG	L	Z																				
6612 63 00	63	91,0	100,0	37,0																				
<p>Ø</p> <p>76</p> <p>100</p> <p>168</p>			<table border="1"> <thead> <tr> <th>Transair®</th> <th>ØD</th> <th>LI</th> <th>Z</th> </tr> </thead> <tbody> <tr> <td>RX12 L1 00</td> <td>76</td> <td>235,5</td> <td>122,3</td> </tr> <tr> <td>RX12 L3 00</td> <td>100</td> <td>271,4</td> <td>138,0</td> </tr> <tr> <td>RA12 L8 00</td> <td>168</td> <td>310,5</td> <td>147,5</td> </tr> </tbody> </table> <p>Use 2 connectors RR01 to connect 45° elbow RX12 to Transair® pipe.</p>		Transair®	ØD	LI	Z	RX12 L1 00	76	235,5	122,3	RX12 L3 00	100	271,4	138,0	RA12 L8 00	168	310,5	147,5				
Transair®	ØD	LI	Z																					
RX12 L1 00	76	235,5	122,3																					
RX12 L3 00	100	271,4	138,0																					
RA12 L8 00	168	310,5	147,5																					

> Pipe-to-pipe and stud connectors

Ø
16,5
25
40

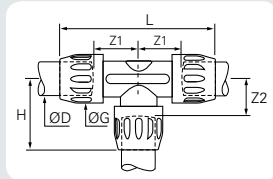

Equal tee

Transair®	ØD	G	H	L	Z1	Z2
6604 17 00	16,5	34,0	58,0	120,5	34,0	31,0
6604 25 00	25	44,5	67,5	151,5	48,0	40,0
6604 40 00	40	67,0	102,5	205,0	57,0	57,0

Ø
63

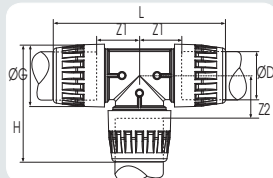

Transair®	ØD	G	H	L	Z1	Z2
6604 63 00	63	91,0	122,0	245,0	61,0	61,0

Ø
76
100
168

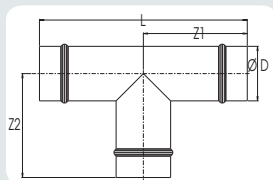

Transair®	ØD	L	Z1	Z2
RX04 L1 00	76	290	145	145
RX04 L3 00	100	310	155	135
RA04 L8 00	168	360	180	185

Use 3 connectors RR01 to connect equal tee RX04 to Transair® pipe.

Ø
63

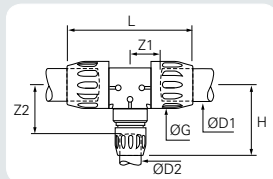

Reducing tee

Transair®	ØD1	ØD2	ØG	H	L	Z1	Z2
6604 63 40	63	40	91,0	161,0	245,0	61,0	116,0

Ø
76
100
168

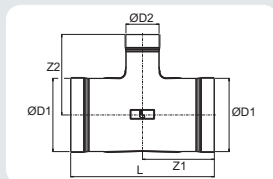

Transair®	ØD1	ØD2	L	Z1	Z2
RX24 L1 40	76	40	290	145	104
RX24 L1 63	76	63	290	145	163
RX24 L3 40	100	40	310	155	116,5
RX24 L3 63	100	63	310	155	175,8
RX04 L3 L1	100	76	310	155	135
RA04 L8 63	168	63	330	165	220
RA04 L8 L1	168	76	330	165	185
RA04 L8 L3	168	100	330	165	185

Use 2 connectors RR01 to connect reducing tee RX24 to Transair® pipes Ø 76 & Ø 100, and pipe-to-pipe connector 6606 to connect Transair® pipes Ø 40 & Ø 63

Ø
76
100

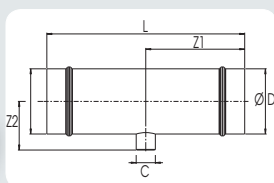

Threaded tee

Transair®	ØD	C	L	Z1	Z2
RX23 L1 04	76	G1/2	290	145	63
RX23 L3 04	100	G1/2	310	155	75,8

Use 2 connectors RR01 to connect threaded tee RX23 to Transair® pipe.

Ø
16,5
25
40

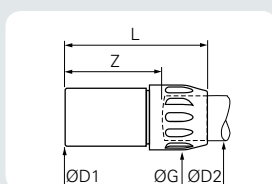

Plug-in reducer

Transair®	ØD1	ØD2	ØG	Z	L
6666 17 25	25	16,5	34,0	50,0	77,0
6666 25 40	40	25	44,5	71,0	100,5

Ø
63

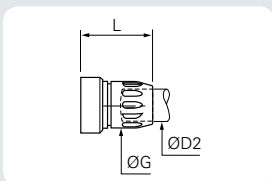

Transair®	ØD1	ØD2	ØG	L
6666 40 63	63	40	67,0	112,5

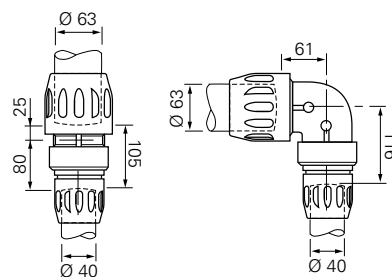

Ø
76
100
168

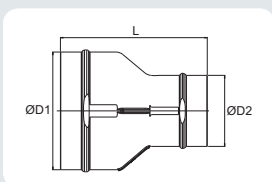

Transair®	ØD1	ØD2	L
RX64 L1 63	76	63	230
RX64 L3 63	100	63	250
RX66 L3 L1	100	76	192,5
RA66 L8 L1	168	76	210
RA66 L8 L3	168	100	210

Use 1 connector RR01 to connect plug-in reducer RX64 to Transair® pipes Ø 76 or Ø 100 and 1 pipe-to-pipe connector 6606 to connect to Transair® pipe Ø 63.

Use 2 x appropriately sized connectors RR01 to join plug-in reducer RX66 to Transair® pipes Ø100 and Ø76

> Pipe-to-pipe and stud connectors

Ø
16,5
25
40

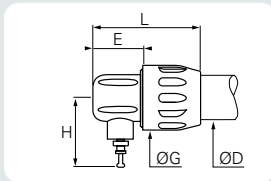

Vented end cap

Transair®	ØD	E	ØG	H	L
6625 17 00	16,5	25,5	34,0	45,5	62,5
6625 25 00	25	33,0	44,5	47,0	75,0
6625 40 00	40	34,5	67,0	55,0	98,5

Model Ø 16,5 : supplied with Ø6 mm plug.

Model Ø 25, Ø 40 and Ø 63 : supplied with Ø8 mm plug.

Ø
63

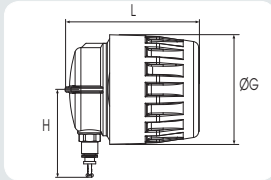

Transair®	ØD	E	ØG	H	L
6625 63 00	63	31,0	91,0	74,0	111

Model Ø 25, Ø 40 and Ø 63 : supplied with Ø8 mm plug.

Ø
76
100
168

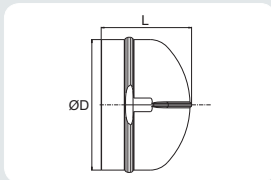

End-cap

Transair®	ØD	L
RX25 L1 00	76	99,6
RX25 L3 00	100	107,4
RA25 L8 00	168	117

Use 1 connectors RR01 to connect end-cap RX25 to Transair® pipe.

Ø
16,5
25
40

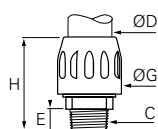

Male stud fitting, BSP taper

Transair®	ØD	C	€	ØG	H
6605 17 13	16,5	R1/4	9,5	34,0	62,5
6605 17 21	16,5	R1/2	15,0	34,0	68,0
6605 25 21	25	R1/2	15,0	44,5	70,5
6605 25 27	25	R3/4	15,0	44,5	71,5
6605 25 34	25	R1"	16,0	44,5	71,5
6605 40 34	40	R1"	16,0	67,0	111,5
6605 40 42	40	R1"1/4	21,5	67,0	111,5
6605 40 49	40	R1"1/2	24,5	67,0	114,5

Ø
63

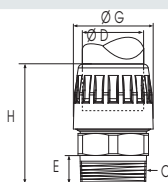

Transair®	ØD	C	€	ØG	H
6605 63 48	63	R2"	26,9	91,0	118,5
6605 63 47	63	R2"1/2	31,5	91,0	130,5

Ø
40

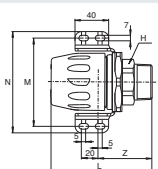

Male stud fitting with fixing plate - BSP taper

Transair®	ØD	C	H	L	K	M	N	Z
6615 40 42	40	R1"1/4	50	121	84	105	120	75
6615 40 49	40	R1"1/2	50	121	84	105	120	75

> Pipe-to-pipe and stud connectors

Ø
16,5
25
40
63

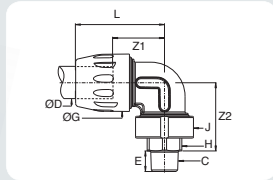

Male stud 90° elbow - BSP taper

Transair®	ØD	C	H	L	Z1	Z2
6609 17 13	16,5	R1/4	17	58,0	31,0	41,2
6609 17 21	16,5	R1/2	23	58,0	31,0	46,5
6609 25 21	25	R1/2	27	69,5	40,5	53,0
6609 25 27	25	R3/4	27	69,5	40,5	53,0
6609 25 34	25	R1"	36	69,5	40,5	55,0
6609 40 34	40	R1"	41	107,0	62,0	75,0
6609 40 42	40	R1"1/4	50	107,0	62,0	81,0
6609 40 49	40	R1"1/2	50	107,0	62,0	81,0
6609 40 48	40	R2"	60	107,0	62,0	81,0
6609 63 48	63	R2"	70	124,0	61,0	105,2
6609 63 47	63	R2"1/2	80	124,0	61,0	106,2

Ø
16,5
25
40
63

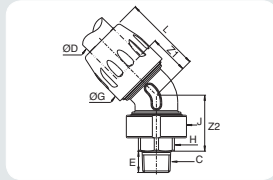

Male stud 45° elbow - BSP taper

Transair®	ØD	C	H	L	Z1	Z2
6619 25 21	25	R1/2	27	61,5	32,5	42,0
6619 25 27	25	R3/4	27	61,5	32,5	42,0
6619 25 34	25	R1"	36	61,5	32,5	44,0
6619 40 34	40	R1"	41	94,0	45,0	58,5
6619 40 42	40	R1"1/4	50	94,0	45,0	64,0
6619 40 49	40	R1"1/2	50	94,0	45,0	64,0
6619 40 48	40	R2"	60	94,0	45,0	64,0
6619 63 48	63	R2"	70	100,0	37,0	81,0
6619 63 47	63	R2"1/2	80	100,0	37,0	82,0

Ø
16,5
25
40

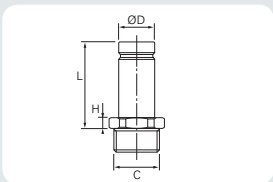

Male adaptor, BSP taper

Transair®	ØD	C	L	H
6621 17 21	16,5	R1/2	42,2	5,0
6621 25 21	25	R1/2	49,0	7,0
6621 25 27	25	R3/4	49,0	7,0
6621 25 34	25	R1"	49,0	7,0
6621 40 42	40	R1"1/4	73,7	8,0
6621 40 49	40	R1"1/2	75,7	10,0

Ø
76

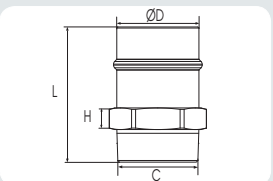

Transair®	ØD	C	L	H
RR05 L1 20	76	R2"1/2	125	20

Use 1 connector RR01 to connect male adaptor RR05 to Transair® pipe.

Ø
25
40

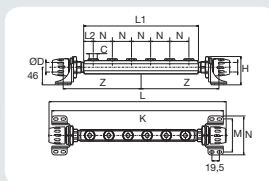
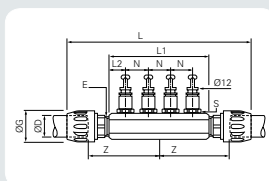

Manifold

Transair®	ØD	G	L	LI	L2	N	Z	€	S
6651 25 12 04	25	44,5	271,0	151,0	23,0	35,0	107,0	G3/4"	G3/8"
6651 40 12 04	40	67,0	400,0	204,0	27,0	50,0	150,0	G1"1/4	G1/2"

Supplied with 4 Ø12 mm plugs (3126 12 00).

Transair®	ØD	C	L	LI	L2	K	N	Z	H	M
6652 25 21 06	25	G1/2	463	300	25	448	50	204	74	86,5
6652 40 21 06	40	G1/2	526	310	25	469	50	217	83	104,5

Ø
76
100
168

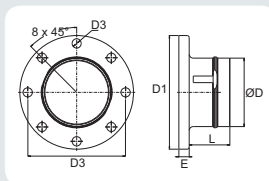

Flange - single

Transair®	ØD	DN	DI	D2	D3	€	L
RX30 L1 00	76	65	185	145	18	10	75
RX30 L1 00 01	76	80	200	160	18	10	75
RX30 L3 00	100	100	220	180	18	10	75
RA31 L8 00	168	150	279	240	22	25	100

Dimensions conform to EN 1092-1 and ISO 7005 standards.



Flange gasket - single

Transair®	ØD	For use with flange reference
EW05 L1 00	76	RX30 L1 00
EW05 L1 00 01	76	RX30 L1 00 01
EW05 L3 00	100	RX30 L3 00
EW05 L8 00	168	RA31 L8 00



Flange bolt kit

Transair®	C	L
EW06 00 01	M16	90
EW06 00 05	M20	80

Contains 8 bolts and 8 nuts.
Tightening torque : 200Nm

> Quick assembly direct feed brackets

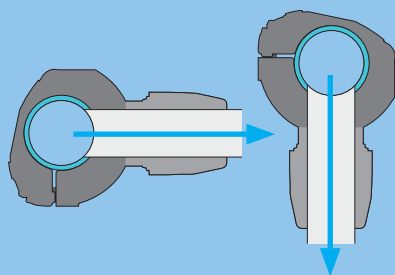

For rigid drops with horizontal take off or for all types of air supply with rigid pipe or flexible hose on an installation which incorporates an efficient air dryer.

- > Optimum flow
- > Compact
- > Well adapted for most OEM applications and for use with neutral gases
- > Quick installation without any cutting of pipe

Quick assembly direct feed bracket

Ø
25
40

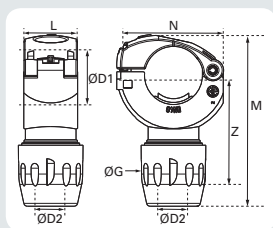

Transair®	ØD1	ØD2	M	G	L	N	Z
RA69 25 17	25	16,5	92	34	37	52	47,5
RA69 40 25	40	25	117	44,5	37	74	61

To drill Transair® pipe, use drilling tools 6698 02 01 and 6698 02 02.

Ø
76
100
168

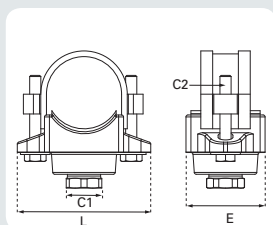

Transair®	ØD	C1	C2	E	L
RR61 L1 08	76	1"	M12	50	137
RR61 L3 08	100	1"	M12	80	158
RR63 L8 12	168	1 1/2"	M16	90	235
RR63 L8 16	168	2"	M16	103	235

RR61 supplied with Ø 25 - 1" adaptor (6621 25 34).
To drill Transair® pipe, use drilling tool EW09.
RR63 supplied without adaptor.

Quick assembly direct feed mini-bracket with female thread

Ø
25
40

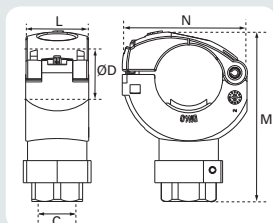

Transair®	ØD	C	L	N	M
RA65 25 04	25	G1/2	37	52	86
RA65 40 04	40	G1/2	37	74	100

Supplied with blanking plug.
To drill Transair® pipe, use drilling tools 6698 02 01 and 6698 02 02.

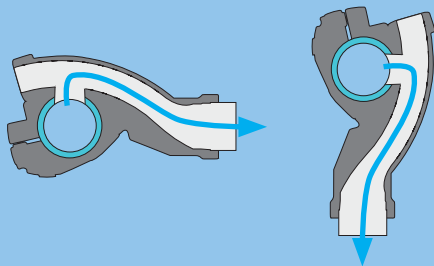

New generation quick assembly brackets are recommended for vertical or horizontal take-offs, using either rigid pipe or flexible hose.

- > Integral water retention device
- > Very high flow
- > Quick installation without any cutting of pipe

<p>Ø 25 40</p>		
<p>Ø 63</p>		
<p>Ø 25 40</p>		
<p>Ø 63</p>		

Quick assembly brackets

Transair®	ØDI	ØD2	M	ØG	L	N	Z
6662 25 17	25	16,5	139,5	34	36	63,5	82
6662 25 00	25	25	134	44,5	36	63,5	74
6662 40 17	40	16,5	154	34	37,5	76,5	89
6662 40 25	40	25	149,5	44,5	37,5	76,5	82

To drill Transair® pipe, use drilling tools 6698 02 01 and 6698 02 02.

Transair®	ØDI	ØD2	M	G	L	N	Z
6662 63 25	63	25	166,5	44,5	50	108,5	75

To drill Transair® pipe, use drilling tool 6698 02 02.

Quick assembly mini-bracket with female thread

Transair®	ØDI	C	M	L	N
6661 25 21	25	G1/2	117,5	36	63,5
6661 40 21	40	G1/2	132	37,5	76,5
6661 40 27	40	G3/4	132	37,5	76,5

Supplied with blanking plug.

To drill Transair® pipe, use drilling tools 6698 02 01 and 6698 02 02.

Transair®	ØDI	C	M	L	N
6661 63 21	63	G1/2	138,9	50	98,5
6661 63 27	63	G3/4	138,9	50	98,5

Supplied with blanking plug.

To drill Transair® pipe, use drilling tool 6698 02 02.

> Quick assembly mini-brackets with coupler

Quick assembly mini-brackets with pre-assembled coupler allow time savings during installation.

Ø
25
40
63

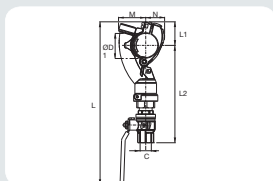

Quick assembly bracket with pre-assembled ball valve - BSP parallel

Transair®	ØD	C	L	LI	L2	M	N
6669 25 21	25	G1/2	256	32,0	155	40,0	23,0
6669 40 21	40	G1/2	270	39,0	162	45,0	31,0
6669 40 27	40	G3/4	302	39,0	174	45,0	31,0
6669 63 21	63	G1/2	275	63,0	142	60,0	48,0
6669 63 27	63	G3/4	297	63,0	146	60,0	48,0

Ø
25
40



Mini-bracket with coupler

Transair®	ØD	C	Profile	Bore (mm)
6660 25 U1	25	G1/2	ISO B	5,5
6660 25 U2	25	G1/2	ISO B	8
6660 25 E4	25	G1/2	EURO	7,2
6660 25 A1	25	G1/2	ARO	5,5
6660 40 U1	40	G1/2	ISO B	5,5
6660 40 U2	40	G1/2	ISO B	8
6660 40 E4	40	G1/2	EURO	7,2
6660 40 A1	40	G1/2	ARO	5,5

Ø
63



Transair®	ØD	C	Profile	Bore (mm)
6660 63 U1	63	G1/2	ISO B	5,5
6660 63 U2	63	G1/2	ISO B	8
6660 63 E4	63	G1/2	EURO	7,2
6660 63 A1	63	G1/2	ARO	5,5

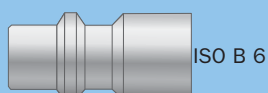

ISO B 6

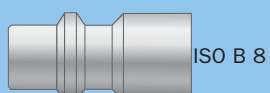

ISO B 8

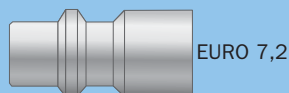

EURO 7,2

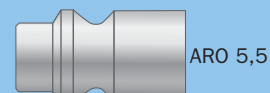



ARO 5,5

> Ideal for fast assembly of new pressurised outlets, without venting the compressed air network.

> The drilling tool can be used with most standard drills.

We recommend, however, that the pipe work network is drained prior to the addition of an outlet. Thanks to the lateral dismantling capability of Transair® pipe and the use of quick assembly brackets, this operation can be completed very quickly (less than 7 min. for a new outlet) and guarantees the interior cleanliness of the circuit.

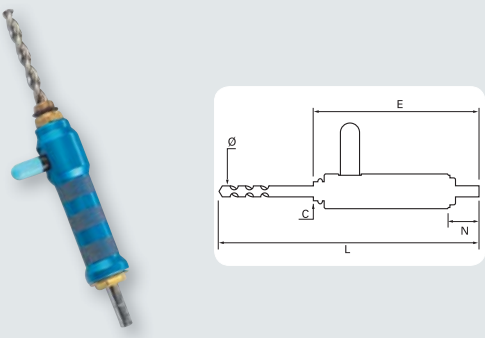
<p>Ø 25 40</p>		<h3>Pressurised system outlet</h3> <table border="1"> <thead> <tr> <th>Transair®</th> <th>ØD</th> </tr> </thead> <tbody> <tr> <td>EA98 06 01</td> <td>25</td> </tr> <tr> <td>EA98 06 02</td> <td>40</td> </tr> </tbody> </table> <p>Bracket with ball valve BSP 1/2"</p>	Transair®	ØD	EA98 06 01	25	EA98 06 02	40						
Transair®	ØD													
EA98 06 01	25													
EA98 06 02	40													
<p>Ø 63</p>		<table border="1"> <thead> <tr> <th>Transair®</th> <th>ØD</th> </tr> </thead> <tbody> <tr> <td>EA98 06 03</td> <td>63</td> </tr> </tbody> </table> <p>Bracket with ball valve BSP 1/2"</p>	Transair®	ØD	EA98 06 03	63								
Transair®	ØD													
EA98 06 03	63													
		<h3>Pressurised system drilling tool</h3> <table border="1"> <thead> <tr> <th>Transair®</th> <th>C</th> <th>ØD</th> <th>L</th> <th>E</th> <th>N</th> </tr> </thead> <tbody> <tr> <td>EA98 06 00</td> <td>G1/2</td> <td>13</td> <td>330,0</td> <td>154,0</td> <td>30,5</td> </tr> </tbody> </table> <p>Sealing washer</p>	Transair®	C	ØD	L	E	N	EA98 06 00	G1/2	13	330,0	154,0	30,5
Transair®	C	ØD	L	E	N									
EA98 06 00	G1/2	13	330,0	154,0	30,5									

> Wall brackets

- > 1 or 2 ports
- > Pre-assembled composite safety couplers (6670 & 6671)
- > For wall or machine mounting
- > Supplied with end-cap
- > Secondary outlet G1/4

- > Working pressure :
-13 bar from -20°C to +60°C
-16 bar from -20°C to +45°C (please consult us for higher temperature requirements)
- > Non-flammable (conforms to UL94-HB standard)
- > Vacuum : 98,7% (13 mbar absolute pressure)
- > Working temperature : -20°C to +60°C

1 port 45° wall bracket - BSP parallel

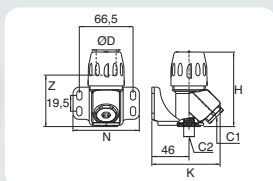

Transair®	ØD	C1	C2	H	Z	K	N
6639 17 21	16,5	G1/2	G1/4	89,5	63,5	84,5	82,0
6639 25 21	25	G1/2	G1/4	92,5	63,5	84,5	82,0

2 port wall bracket - BSP parallel

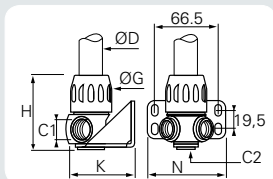

Transair®	ØD	C1	C2	G	H	K	N
6681 17 21	16,5	G1/2	G1/4	34	65	74,5	82
6681 25 21	25	G1/2	G1/4	44,5	81	74,5	82

Ø
16,5
25

2 port 45° wall bracket - BSP parallel

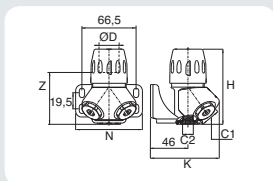

Transair®	ØD	C1	C2	H	Z	K	N
6682 17 21	16,5	G1/2	G1/4	89,5	63,5	84,5	82,0
6682 25 21	25	G1/2	G1/4	92,5	63,5	84,5	82,0

3 port wall bracket - BSP parallel

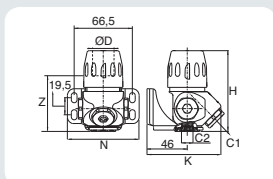

Transair®	ØD	C1	C2	H	Z	K	N
6695 25 21	25	G1/2	G1/4	92,5	63,5	84,5	82,0

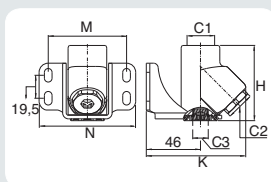

1 port 45° threaded wall bracket - BSP parallel

Transair®	C1	C2	C3	H	K	M	N
6690 21 21	G1/2	G1/2	G1/4	64,0	84,5	66,5	82,0

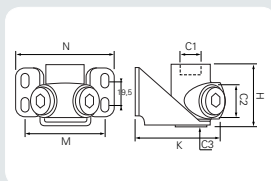

2 port threaded wall bracket - BSP parallel

Transair®	C1	C2	C3	H	K	M	N
6686 21 21	G1/2	G1/2	G1/4	48	72,5	66,5	82

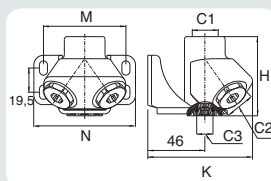

2 port 45° threaded wall bracket - BSP parallel

Transair®	C1	C2	C3	H	K	M	N
6641 21 21	G1/2	G1/2	G1/4	64,0	84,5	66,5	82,0

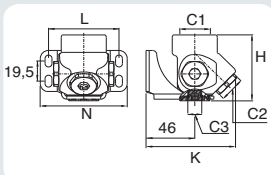

3 port threaded wall bracket - BSP parallel

Transair®	C1	C2	C3	H	Z	K	N
6635 27 21	G3/4	G1/2	G1/4	64,0	84,5	66,5	82,0

> Wall brackets

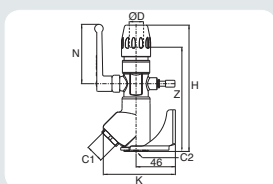

1 port 45° threaded wall bracket with ball valve - BSP parallel

Transair®	ØD	CI	C2	H	Z	K	N
6678 17 21	16,5	G1/2	G1/4	148,5	123,0	84,5	69,5
6678 25 21	25	G1/2	G1/4	173,0	142,0	84,5	108,5

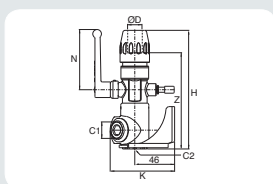

2 port 90° threaded wall bracket with ball valve - BSP parallel

Transair®	ØD	CI	C2	H	Z	K	N
6672 17 21	16,5	G1/2	G1/4	137,0	111,5	74,5	69,5
6672 25 21	25	G1/2	G1/4	163,0	132,0	74,5	108,5

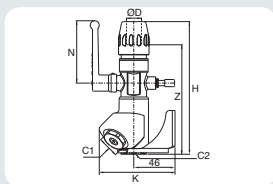

2 port 45° wall bracket with ball valve - BSP parallel

Transair®	ØD	CI	C2	H	Z	K	N
6693 17 21	16,5	G1/2	G1/4	148,5	123,0	84,5	69,5
6693 25 21	25	G1/2	G1/4	173,0	142,0	84,5	108,5

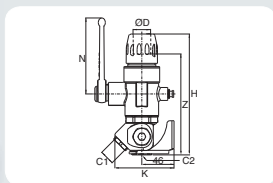

3 port wall bracket with ball valve - BSP parallel

Transair®	ØD	CI	C2	H	Z	K	N
6637 25 21	25	G1/2	G1/4	173,0	142,0	84,5	108,5

Ø
16,5
25

Ø
25

∅
16,5
25



1 port 45° wall bracket with coupler - BSP parallel

Transair®	∅D	Profile	Bore (mm)
6677 17 A1	16,5	ARO	5,5
6677 17 E4	16,5	EURO	7,2
6677 17 U1	16,5	ISO B	6
6677 17 U2	16,5	ISO B	8
6677 25 A1	25	ARO	5,5
6677 25 E4	25	EURO	7,2
6677 25 U1	25	ISO B	6
6677 25 U2	25	ISO B	8



2 port 45° wall bracket with coupler - BSP parallel

Transair®	∅D	Profile	Bore (mm)
6692 17 A1	16,5	ARO	5,5
6692 17 E4	16,5	EURO	7,2
6692 17 U1	16,5	ISO B	6
6692 17 U2	16,5	ISO B	8
6692 25 A1	25	ARO	5,5
6692 25 E4	25	EURO	7,2
6692 25 U1	25	ISO B	6
6692 25 U2	25	ISO B	8



2 port wall bracket with coupler

Transair®	∅D	Profile	Bore (mm)
6671 17 U1	16,5	ISO B	5,5
6671 17 U2	16,5	ISO B	8,0
6671 17 E4	16,5	EURO	7,2
6671 17 A1	16,5	ARO	5,5
6671 25 U1	25	ISO B	5,5
6671 25 U2	25	ISO B	8,0
6671 25 E4	25	EURO	7,2
6671 25 A1	25	ARO	5,5

1/2" BSP parallel connection between the wall bracket and the composite safety coupler.

Couplers supplied with each wall bracket are ready for immediate use.

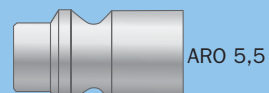
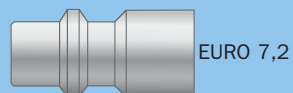
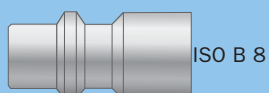
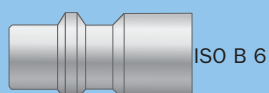

> Ball valves and Butterfly Valves

Transair® ball valves and butterfly valves placed regularly throughout the network and at key locations, such as compressor outlets and upstream of pneumatic tools, allow ease of system isolation and pipe work reconfiguration / maintenance.

- > Quick connection
- > Available in lockable version (only in Ø 63)
- > Manual or piloted operation (only in Ø 40)

Ø
16,5
25

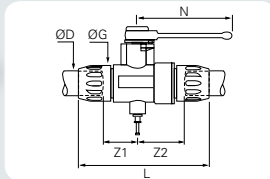

Double female, vented

Transair®	ØD	G	L	N	Z1	Z2
4089 17 00	16,5	34,0	120,0	69,5	29,0	42,0
4089 25 00	25	44,5	152,0	108,5	40,0	55,0

Model 4089 17 00 : supplied with Ø6 mm plug.
Model 4089 25 00 : supplied with Ø8 mm plug.

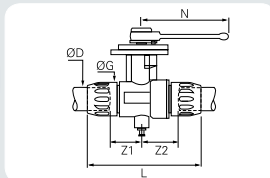

Lockable valve, vented

Transair®	ØD	G	L	N	Z1	Z2
4099 17 00	16,5	34,0	121,0	69,0	29,0	42,0
4099 25 00	25	44,5	151,7	108,3	40,0	55,0

Model 4099 17 00 : supplied with Ø6 mm plug.
Model 4099 25 00 : supplied with Ø8 mm plug.

Ø
40

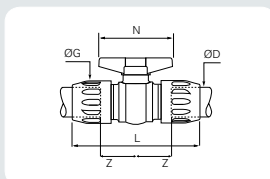

Double female valve

Transair®	ØD	G	L	N	Z
4002 40 00	40	67,0	205,0	122,0	57,0

Ø
63

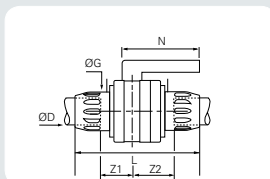

Transair®	ØD	G	L	N	Z1	Z2
4002 63 00	63	91,0	278,0	185,0	79,0	93,0

Lockable valve

Transair®	ØD	G	L	N	Z1	Z2
4012 63 00	63	91,0	278,0	185,0	79,0	93,0

Ø
76
100
168

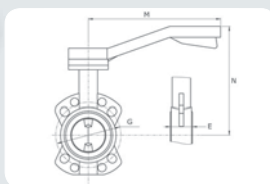

Butterfly Valve

Transair®	ØD	DN	G	M	N	E
VR02 L1 00	76	80	145	300	250	50
VR02 L3 00	100	100	180	270	210	56
VR02 L8 00	168	150	240	300	290	56

Model with CE marking. Supplied with bolts.

- > Max. working pressure :
 - 13 bar from -20°C to +60°C
 - 16 bar from -20°C to +45°C
 (please consult us for higher temperature requirements)
- > Vacuum : 98,7%
(13 mbar absolute pressure)
- > Working temperature : -20°C to +60°C

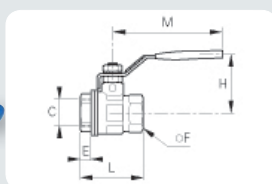

Double female valve, BSP parallel

Transair®	C	DN	Max. Pressure (bar)	E	F	H	L	M
VR03 00 02	G1/4	10	30	11,4	20	43	51,5	98
VR03 00 03	G3/8	10	30	11,4	20	43	51,5	98
VR03 00 04	G1/2	15	30	13,5	25	47	55	98
VR03 00 06	G3/4	20	30	12,5	31	58	57,5	122
VR03 00 08	G1"	25	30	15	38	60	69,5	122
VR03 00 10*	G1"1/4	32	25	17	48	77	81,5	153
VR03 00 12*	G1"1/2	40	25	28	54	83	95	153
VR03 00 16*	G2"	50	25	22	66	95	113	162
VR03 00 20*	G2"1/2	61	16	24	84	95	132,5	24

*Model with CE marking.

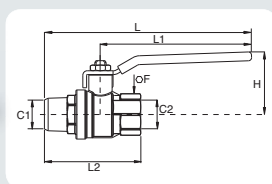

Male-Female ball valve - male BSP taper, female BSP parallel

Transair®	C1	C	DN	Max. Pressure (bar)	F	H	L	U	L2
VR04 00 04	R1/2	G1/2	15,0	40	25	43,0	140,5	100	70,0
VR04 00 06	R3/4	G3/4	20,0	40	31	50,0	164,5	120	76,5
VR04 00 08	R1"	G1"	25	40	40	54	172	120	92,5
VR04 00 10	R1"1/4	G1"1/4	32	40	49	73	217,5	158	106
VR04 00 12	R1"1/2	G1"1/2	40	40	54	79	220	158	113
VR04 00 16	R2"	G2"	50	40	68,5	86	230,5	158	133
VR04 00 20	R2"1/2	G2"1/2	65	30	85	132	357,5	255	180,5

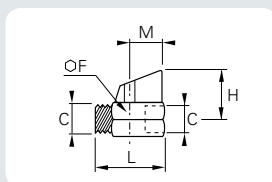

Mini-valve, male and female, BSP taper

Transair®	C	DN	F	H	L	M
4981 10 21TR	R1/2	10	25	31	46	20,5

Max. working pressure : 10 bar

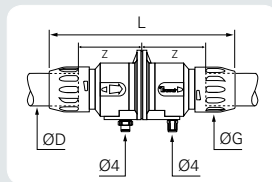

Remote control shut-off valve

Transair®	ØD	G	L	Z
4230 00 40	40	67	261	85,0

Min. working pressure : 4 bar • Max. working pressure : 13 bar
The Transair® remote control shut-off valve is supplied with a plugged vent hole.

This allows venting of the downstream network, after closing the valve.

Ø
40

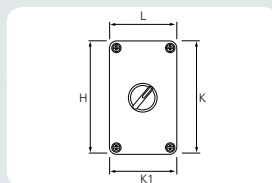

Pilot kit

Transair®	H	K	K1	L
4299 03 01	145	106	70	82

This pilot kit comprises : pneumatic ON/OFF switch (maximum 10 bar operating pressure), twin 4 mm OD polyurethane tube (length 10 m) and plastic box.

> Tools

> Practical tools for the installation and extension of Transair® air pipe networks.

> Presented in a carrying case, or available as separate parts.

Ø
16,5
↓
40



Tool case

Transair®	H	L	I
6698 00 04	315	290	105

Contents of tool case 6698 00 04:

- Drilling jig 6698 01 01
- Drilling tools 6698 02 01 and 6698 02 02
- Cutter for rigid pipe 6698 03 01
- Chamfer tool 6698 04 01
- Deburring tool 6698 04 02
- Marking tool 6698 04 03

Ø
16,5
↓
63



Transair®	H	L	I
6698 00 03	315	290	105

Contents of tool case 6698 00 03:

- Drilling jigs 6698 01 01 and 6698 01 02
- Drilling tools 6698 02 01 and 6698 02 02
- Cutter for rigid pipe 6698 03 01
- Chamfer tool 6698 04 01
- Deburring tool 6698 04 02
- Set of tightening spanners 6698 05 03
- Marking tool 6698 04 03

Ø
16,5
↓
168

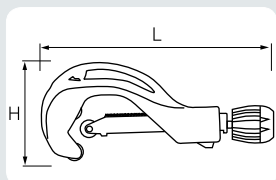

Cutter for rigid aluminium pipe

Transair®	L	H	Used for Transair® pipe
6698 03 01	230	98	Ø 16,5 - 25 - 40 - 63
EW08 00 01	360	155	Ø 63 - 76 - 100
EW08 00 03	600	300,0	Ø 168

- Spare rotary cutter blade for Transair® cutter 6698 03 01 : EW08 00 99
- Spare rotary cutter blade for Transair® cutter EW08 00 01 : EW08 00 02
- Spare rotary cutter blade for Transair® cutter EW08 00 03 : EW08 00 04

Ø
25
↓
40

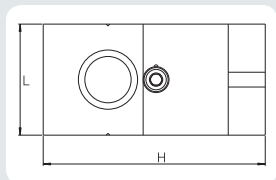

Drilling jig for rigid aluminium pipe

Transair®	H	L	Used for Transair® pipe
6698 01 01	120	60	Ø 25 - 40

After drilling, de-burr and clean the pipe.



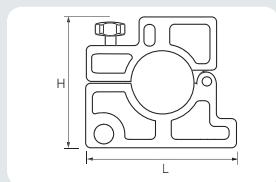

Ø
63

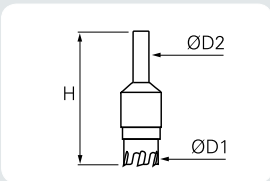

Drilling jig for rigid aluminium pipe

Transair®	H	L	Used for Transair® pipe
6698 01 02	134	155	Ø 63

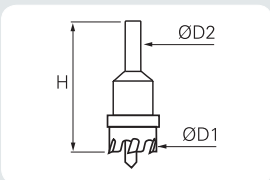
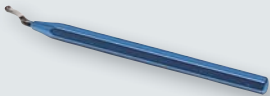
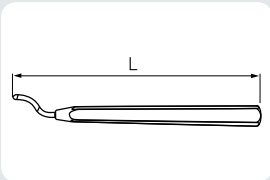
After drilling, de-burr and clean the pipe.

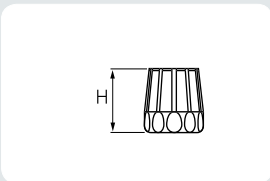
<p>Ø 25 ↓ 63</p>	 	<p>Drilling tool for rigid aluminium pipe</p> <table border="1"> <thead> <tr> <th>Transair®</th> <th>ØD1</th> <th>ØD2</th> <th>H</th> <th>For Transair® pipe</th> </tr> </thead> <tbody> <tr> <td>6698 02 02</td> <td>16</td> <td>12</td> <td>71</td> <td>Ø 25</td> </tr> <tr> <td>6698 02 01</td> <td>22</td> <td>12</td> <td>71</td> <td>Ø 40 - 63</td> </tr> </tbody> </table> <p>Drilling tool 6698 02 02 allows the installation of Ø 25 Transair® brackets.</p> <p>Drilling tool 6698 02 01 allows the installation of Ø 40 or Ø 63 Transair® brackets. It is also used to create the 2 holes needed for double-clamp ring connectors when cutting to length Ø.</p> <p>Both tools can be used with all types of drill, with the drilling tool 6698 01 01 or 6698 01 02, at a maximum rotation speed of 650 tr/min.</p>	Transair®	ØD1	ØD2	H	For Transair® pipe	6698 02 02	16	12	71	Ø 25	6698 02 01	22	12	71	Ø 40 - 63										
Transair®	ØD1	ØD2	H	For Transair® pipe																							
6698 02 02	16	12	71	Ø 25																							
6698 02 01	22	12	71	Ø 40 - 63																							
<p>Ø 76 100 168</p>	 	<table border="1"> <thead> <tr> <th>Transair®</th> <th>ØD1</th> <th>ØD2</th> <th>H</th> <th>For Transair® pipe</th> </tr> </thead> <tbody> <tr> <td>EW09 00 22</td> <td>22</td> <td>10</td> <td>69</td> <td>Ø 40 - 63</td> </tr> <tr> <td>EW09 00 30</td> <td>30</td> <td>12</td> <td>71</td> <td>Ø 76 - 100</td> </tr> <tr> <td>EW09 00 51</td> <td>51</td> <td>12</td> <td>110</td> <td>Ø 168</td> </tr> <tr> <td>EW09 00 64</td> <td>64</td> <td>12</td> <td>110</td> <td>Ø 168</td> </tr> </tbody> </table> <p>Thanks to its unique design, EW09 00 22 drilling tool may be used to carefully drill pipes without use of jig 6698 01 01.</p> <p>The EW09 00 30 drilling tool allows the installation of RR61 Transair® direct feed bracket when using Ø 76 & Ø 100 diameter pipe.</p> <p>Both tools can be used on any type of drilling machine, without the drilling jig, at a maximum rotation speed of 450 tr/min for the aluminium tubes. After drilling, it is necessary to deburr and clean the tube.</p>	Transair®	ØD1	ØD2	H	For Transair® pipe	EW09 00 22	22	10	69	Ø 40 - 63	EW09 00 30	30	12	71	Ø 76 - 100	EW09 00 51	51	12	110	Ø 168	EW09 00 64	64	12	110	Ø 168
Transair®	ØD1	ØD2	H	For Transair® pipe																							
EW09 00 22	22	10	69	Ø 40 - 63																							
EW09 00 30	30	12	71	Ø 76 - 100																							
EW09 00 51	51	12	110	Ø 168																							
EW09 00 64	64	12	110	Ø 168																							
<p>Ø 16,5 ↓ 100</p>	 	<p>Deburring tool for rigid aluminium pipe</p> <table border="1"> <thead> <tr> <th>Transair®</th> <th>L</th> </tr> </thead> <tbody> <tr> <td>6698 04 02</td> <td>140</td> </tr> </tbody> </table>	Transair®	L	6698 04 02	140																					
Transair®	L																										
6698 04 02	140																										
<p>Ø 16,5 25 40</p>	 	<p>Chamfer tool for rigid aluminium pipe</p> <table border="1"> <thead> <tr> <th>Transair®</th> <th>H</th> </tr> </thead> <tbody> <tr> <td>6698 04 01</td> <td>64</td> </tr> </tbody> </table>	Transair®	H	6698 04 01	64																					
Transair®	H																										
6698 04 01	64																										

Ø
16,5
25
40

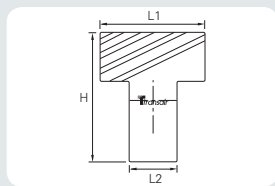

Marking tool for rigid aluminium pipe

Transair®	H	LI	L2
6698 04 03	88	73	33

The marking tool enables connection guidelines to be marked on cut lengths of Transair® pipe. These marks indicate the insertion limits of the pipe into each fitting in order to ensure good airtight connection and security of grip.



Ø
63



Set of tightening spanners for Ø 63 nuts

Transair®
6698 05 03

This set includes 2 tightening spanners.

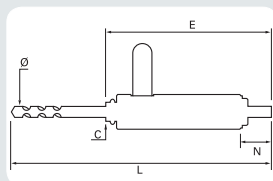

Pressurised system drilling tool

Transair®	C	ØD	L	E	N
EA98 06 00	G1/2	13	330,0	154,0	30,5

Sealing washer



Portable tool kit

Transair®	V
EW01 00 01	220
EW01 00 03	110

This case contains : 1 portable tool, 1 12V battery and battery charger.

Ø
76
100
168

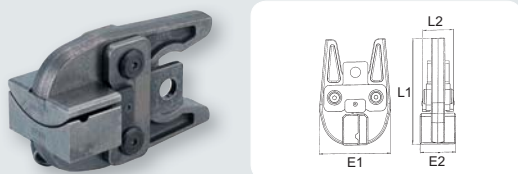

Jaw set for portable tool

Transair®	ØD	EI	E2	L1	L2
EW02 L1 00	76	103	52	154	46
EW02 L3 00	100	103	71	154	46
EW02 L8 00	168	103	71	154	46



12V battery for portable tool

Transair®
EW03 00 01

> Fixture and accessories

- > Easy adaptation for all pipework configurations
- > For suspension of pipes, from walls, partitions, beams, cable trays, Canalis electrical installations, etc, vertically or horizontally
- > Perfectly adapted for use with Transair® networks

Ø
16,5
25
40

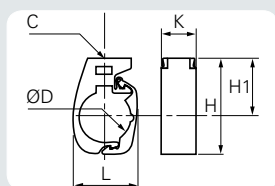

Fixing clip for rigid pipe

Transair®	ØD	C	HI	H	K	L
6697 17 00	16,5	M6X1	46	61	30	32,5
6697 25 00	25	M6X1	46	65,5	30	38,5
6697 40 00	40	M6X1	46	74,5	30	50

To ensure good stability of the network, we recommend the use of at least 2 clips per pipe.
Use only this clip for fixing Transair® rigid pipe, all other types of clip are to be avoided.

Ø
63

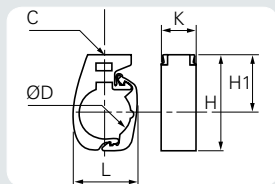

Transair®	ØD	C	HI	H	K	L
6697 63 00	63	M10X1,5	90	127,5	30	73,5

To ensure good stability of the network, we recommend the use of at least 2 clips per pipe.
Use only this clip for fixing Transair® rigid pipe, all other types of clip are to be avoided.

Ø
76
100
168

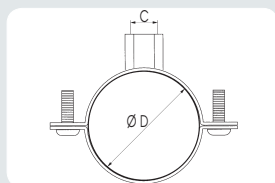

Fixing clip for rigid pipe

Transair®	ØD	C
ER01 L1 00	76	M8 / M10
ER01 L3 00	100	M8 / M10
ER01 L8 00	168	M8 / M10

To ensure good stability of the network, we recommend the use of at least 2 clips per pipe.
Use only this clip for fixing Transair® rigid pipe, all other types of clip are to be avoided.

Ø
16,5
↓
63

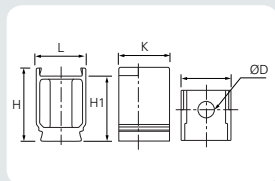

Spacer

Transair®	ØD	H	HI	K	L
6697 00 03	11	49,5	44	34	33

This spacer, in association with a Transair® pipe clip, allows consistent alignment of pipes when different diameters of pipe are run concurrently in the same line.

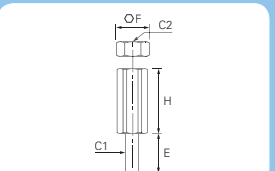
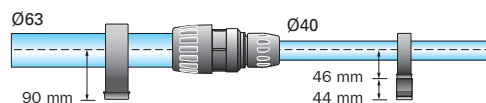

Clip adaptor for threaded rod

Transair®	C1	C2	E	F	H
6697 00 01	M6X1	M8X1,25	16	13	30
6697 00 02	M6X1	M10X1,5	16	13	30

The use of this adaptor facilitates the suspension of Transair® from M8 or M10 threaded rod.

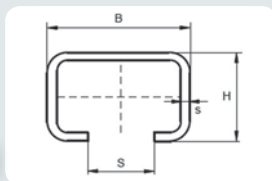
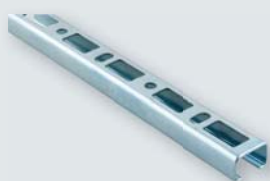

U-Channel

Transair®	L	H	B	kg
6699 01 01	2000	30	30	1,584

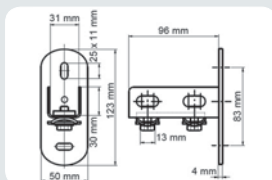

Transair®	L	H	kg
6699 01 02	50	123	0,176

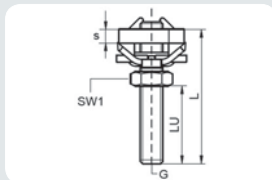

Transair®	L	G	clip ØD	kg
6699 01 03	50	M10	63 - 76 - 100	0,050
6699 01 04	40	M8		0,020
6699 01 05	40	M6	16,5 - 25 - 40	0,010

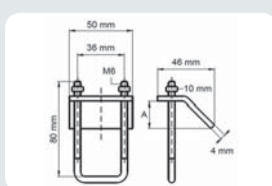
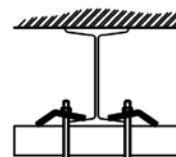

Transair®	L	H	kg
6699 03 02	50	80	0,080

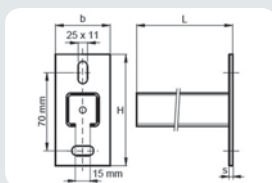

Transair®	L	H	B	kg
6699 01 06	500	110	48	0,400

> Fixture accessories

Ø
16,5
↓
100

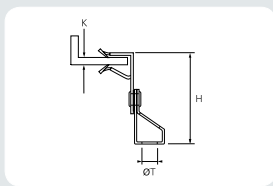

Push-on type beam clamp

Transair®	H	K	ØT	Max carrying load (kg)
6699 02 01	44	1,5 to 3	M6	68
6699 02 02	46	3 to 8	M6	68
6699 02 03	54	8 to 14	M6	68
6699 02 04	66	14 to 20	M6	68
6699 02 05	44	1,5 to 3	M10	68
6699 02 06	46	3 to 8	M10	68

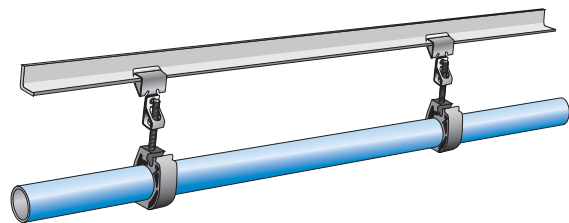

Ø
16,5
25
40

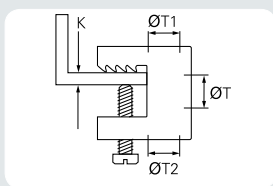

Screw type beam clamp

Transair®	ØT2	ØT	ØT1	K	Max carrying load (kg)
6699 03 01	10,7	6,5	10,7	18	45

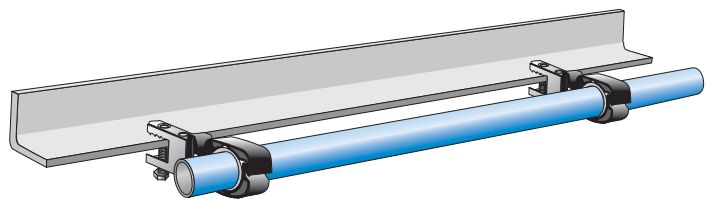

Ø
63
76
100



Transair®	For screw
ER99 06 02	M8
ER99 06 03	M10

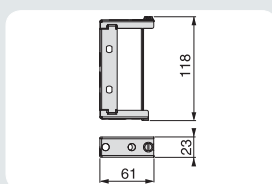

Fixture for CANALIS KN

Transair®	H	K	N
6699 10 01	118	61	23

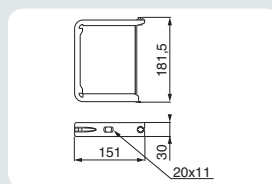
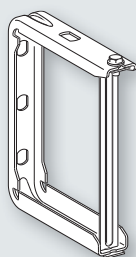

Fixture for CANALIS KS

Transair®	H	K	N
6699 10 02	181,5	151	30

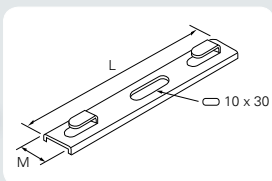
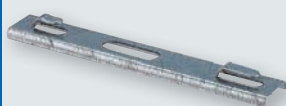

Fixture for cable tray

Transair®	L	M
6699 10 03	140	22

Ø tray metal rod: from 4 to 6 mm.

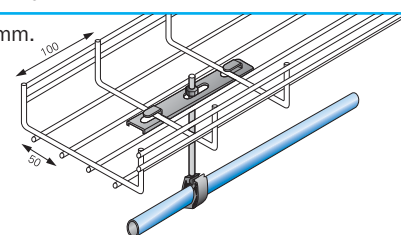

Threaded rod kit

Transair®	C
ER99 05 01	M6
ER99 05 02	M8
ER99 05 03	M10

Contains 10 threaded rods 1 metre length, 50 nuts and 10 threaded connectors

> Hose reels – Blow gun

Hose reels

- > Optimize productivity and the safety of your work area
- > Prevent hose damage occurring on the workshop floor
- > Maximum working pressure, dependant on the model :
 - 6698 10 01 : 12 bar
 - 6698 10 02 : 15 bar
 - 6698 11 01 : 20 bar
- > Working temperature : -5°C to +40°C

Blowgun

- > Dusting, cooling and drying components
- > Removing swarf
- > Cleaning machinery
- > Max. working pressure : 12 bar
- > Working temperature : -20°C to +50°C

10 m

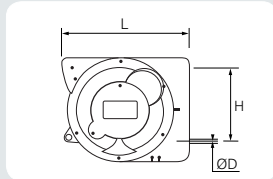

Light series hose reel, 10 m

Transair®	ØD	Hose i.d. (mm)	Max. Pressure(bar)	H	L
6698 10 01	12	8	12	251	300

Enclosed case
Hose clutch with free return
Input connection G1/4 male, output G1/4

16 m

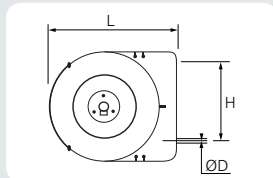

Light series hose reel, 16 m

Transair®	ØD	Hose i.d. (mm)	Max. Pressure(bar)	H	L
6698 10 02	12	8	15	251	390

Enclosed case
Hose clutch with free return
Input connection G1/4 male, output hose only

21 m

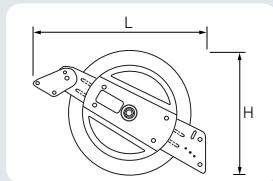

Heavy duty hose reel, 21 m

Transair®	ØD	Hose i.d. (mm)	Max. Pressure(bar)	H	L
6698 11 01	13,5	10	20	430	600

Open case with roller guides
Hose outlet with free return
Input connection G1/2 male, output G3/8

Pivoting bracket

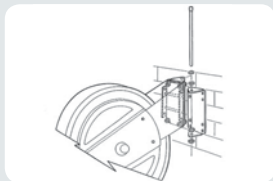

Transair®	Used with hose reel
6698 11 98	6698 11 01

Blowgun

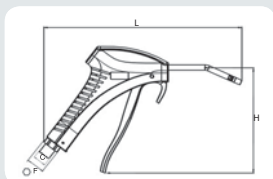

Transair®	C	DN	H	L
EA59 00 13	G1/4	3,5	120	223,0

Braided PVC hose

- > Resistant and suitable for direct supply to machinery and hose reels, etc.
- > Fluid : compressed air
- > Max. working pressure at 23°C : 20 bar
- > Working temperature : from -15°C to +60°C

Polyurethane recoil tubing

- > Perfectly suited to installations requiring flexibility in a reduced space.
- > Fluid : compressed air
- > Max. working pressure at 20°C : 10 bar
- > Working temperature: -15°C to +70°C

2 m

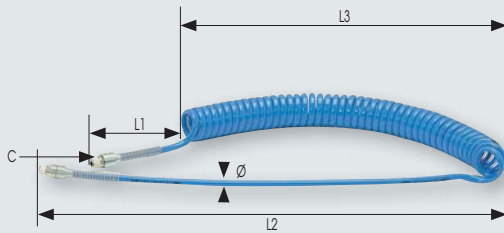

4 m

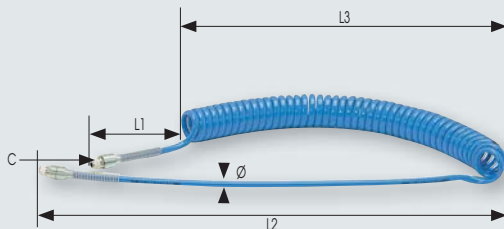

6 m

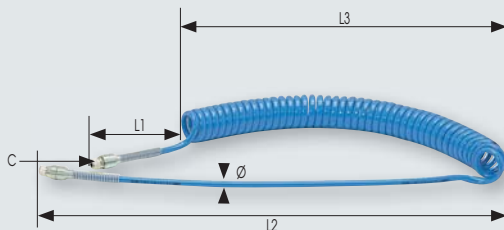

25 m

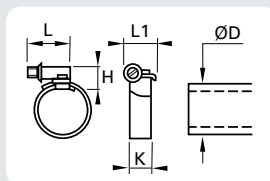

PU recoil tubing - extended length 2 m, 4 m, 6 m

Transair®	Øout.	Øin.	C	L1	L2	L3	Ø
1470U06 04 13TR	6	4	R1/4	100	300	630	32
1470U08 04 13TR	8	5	R1/4	100	500	780	42
1470U10 04 13TR	10	7	R1/4	100	500	780	62
1470U12 04 17TR	12	8	R3/8	100	500	780	65

Transair®	Øout.	Øin.	C	L1	L2	L3	Ø
1471U06 04 13TR	6	4	R1/4	100	300	850	32
1471U08 04 13TR	8	5	R1/4	100	500	1000	42
1471U10 04 13TR	10	7	R1/4	100	500	1000	62
1471U12 04 17TR	12	8	R3/8	100	500	990	65

Transair®	Øout.	Øin.	C	L1	L2	L3	Ø
1472U08 04 13TR	8	5	R1/4	100	500	1230	42
1472U10 04 13TR	10	7	R1/4	100	500	1140	62
1472U12 04 17TR	12	8	R3/8	100	500	1190	65

Braided PVC hose 25 m

Transair®	Øout.	Øin.	Bend radius (mm)
1025V12 04 06TR	12	6	50
1025V14 04 08TR	14	8	65
1025V16 04 10TR	16	10	75
1025V20 04 13TR	20	13	90
1025V24 04 16TR	24	16	125



Clip for braided hose

Transair®	ØD	H	K	L	L1
0697 00 02TR	12-14	12	9	21	13
0697 00 03TR	16	12	9	24	13
0697 00 04TR	20	12	9	24	13
0697 00 05TR	24	12	9	24	13

> Composite automatic safety couplers

- > For quick and repetitive connection and disconnection
- > 100% safety – ISO 4414 and EN 983 compliant
- > Very high flow, extremely low pressure loss
- > Lightweight and robust
- > Improved hand grip
- > Fast vent time
- > Male thread with integral seal
- > Suitable fluids : compressed air, argon, nitrogen (please consult us for other fluids)
- > Max. working temperature : 16 bar
- > Working temperature : from -20°C to +60°C

For heavy duty or dusty applications, we recommend the use of the automatic metal couplers (page 42/43)

ISO B 5,5 mm Safety	Male body, BSP parallel	Female body, BSP parallel	Body with hosetail
	Transair® C <u>CP01 U1 02</u> G1/4 <u>CP01 U1 03</u> G3/8 <u>CP01 U1 04</u> G1/2		Transair® ØD <u>CP21 U1 06</u> 6 <u>CP21 U1 08</u> 8 <u>CP21 U1 10</u> 10
	Transair® C <u>CP01 U2 02</u> G1/4 <u>CP01 U2 03</u> G3/8 <u>CP01 U2 04</u> G1/2		Transair® ØD <u>CP21 U2 08</u> 8 <u>CP21 U2 10</u> 10 <u>CP21 U2 13</u> 13
	Transair® C <u>CP01 E4 02</u> G1/4 <u>CP01 E4 03</u> G3/8 <u>CP01 E4 04</u> G1/2		Transair® ØD <u>CP21 E4 08</u> 8 <u>CP21 E4 10</u> 10 <u>CP21 E4 13</u> 13
	Transair® C <u>CP01 A1 02</u> G1/4 <u>CP01 A1 03</u> G3/8 <u>CP01 A1 04</u> G1/2		Transair® ØD <u>CP21 A1 06</u> 6 <u>CP21 A1 08</u> 8 <u>CP21 A1 10</u> 10



Safety

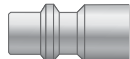

ISO B 5,5 mm
ISO 6150 B
AFNOR NF 49-053
US.MIL.C4109
CEJN 310
RECTUS 23-24



ISO B 8 mm
ISO 6150 B
AFNOR NF 49-053
US.MIL.C4109
CEJN 430
RECTUS 30



EURO 7,2 mm
CEJN 320
RECTUS 25-26



ARO 5,5 mm
ARO 210
CEJN 300
ORION 44510
PARKER 50
RECTUS 14-22

Flow curve –
pressure loss

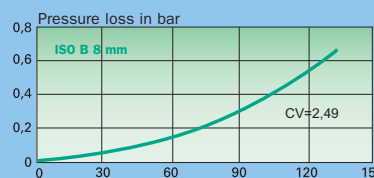













Transair® composite automatic couplers comply with worldwide ISO 4414 and European EN 983 safety standards. Disconnection is by a double twist of the sleeve – a safety feature that breaks deliberately with common practice in order to avoid accidental disconnection.

1st rotation in direction of the arrow : circuit rapidly flushed out, probe side.



2nd rotation in direction of the arrow : safe disconnection of body and probe.



ISO B	Male probe BSP parallel	Female probe BSP parallel	Probe with hosetail
5,5 mm	 <p>Transair® C</p> <p>CA87 U1 02 G1/4 CA87 U1 03 G3/8 CA87 U1 04 G1/2</p>	 <p>Transair® C</p> <p>CA86 U1 02 G1/4 CA86 U1 03 G3/8 CA86 U1 04 G1/2</p>	 <p>Transair® ØD</p> <p>CA94 U1 06 6 CA94 U1 08 8 CA94 U1 10 10</p>
8 mm	 <p>Transair® C</p> <p>CA87 U2 02 G1/4 CA87 U2 03 G3/8 CA87 U2 04 G1/2</p>	 <p>Transair® C</p> <p>CA86 U2 02 G1/4 CA86 U2 03 G3/8 CA86 U2 04 G1/2</p>	 <p>Transair® ØD</p> <p>CA94 U2 08 8 CA94 U2 10 10 CA94 U2 13 13</p>
EURO 7,2 mm	 <p>Transair® C</p> <p>CA87 E4 02 G1/4 CA87 E4 03 G3/8 CA87 E4 04 G1/2</p>	 <p>Transair® C</p> <p>CA86 E4 02 G1/4 CA86 E4 03 G3/8 CA86 E4 04 G1/2</p>	 <p>Transair® ØD</p> <p>CA94 E4 08 8 CA94 E4 10 10 CA94 E4 13 13</p>
ARO 5,5 mm	 <p>Transair® C</p> <p>CA87 A1 02 G1/4 CA87 A1 03 G3/8 CA87 A1 04 G1/2</p>	 <p>Transair® C</p> <p>CA86 A1 02 G1/4 CA86 A1 03 G3/8 CA86 A1 04 G1/2</p>	 <p>Transair® ØD</p> <p>CA94 A1 06 6 CA94 A1 08 8 CA94 A1 10 10</p>

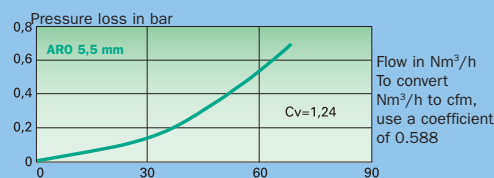
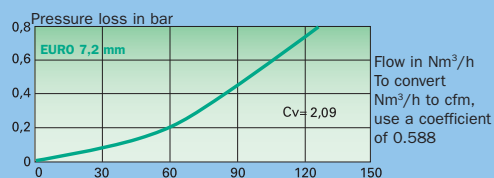

> Metal automatic safety couplers

> Safety and single shut-off versions







- safety : disconnection in 2 stages.
- single shut-off : when disconnecting the body and the probe cannot be separated as long as the button is depressed, allowing downstream pressure to be manually vented.

> Suitable fluids :

- models ISO B 6 and 8 mm safety version : compressed air, vacuum, argon, nitrogen
- models ISO C 6, 8 and 11 mm safety version : compressed air, vacuum, argon, nitrogen
- models ISO C 6 mm single shut-off version : compressed air

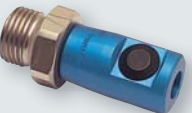
> Vacuum :

- models ISO B 6 and 8 mm safety version: 98,7% (13 mbar absolute pressure)
- models ISO C 6, 8 and 11 mm safety version : 98,7% (13 mbar absolute pressure)
- models ISO C 6 mm single shut-off version : 98,7% (13 mbar absolute pressure)

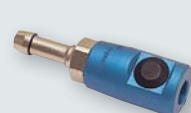
	Male body, BSP taper	Female body, BSP parallel	Body with hosetail
ISO B 6 8 mm Safety	 Transair® C $\overline{\text{DN}}$ 9D05 09 13P4 R1/4 5,5 9D05 09 17P4 R3/8 5,5 9D05 09 21P4 R1/2 5,5 9D05 10 13P4 R1/4 8 9D05 10 17P4 R3/8 8 9D05 10 21P4 R1/2 8	 Transair® C $\overline{\text{DN}}$ 9D14 09 13P4 G1/4 5,5 9D14 09 17P4 G3/8 5,5 9D14 09 21P4 G1/2 5,5 9D14 10 13P4 G1/4 8 9D14 10 17P4 G3/8 8 9D14 10 21P4 G1/2 8	 Transair® $\overline{\text{DN}}$ 9D21 09 06P4 6 5,5 9D21 09 08P4 8 5,5 9D21 09 10P4 10 5,5 9D21 10 08P4 8 8 9D21 10 10P4 10 8
ISO C 6 8 11 mm Safety	 Transair® C $\overline{\text{DN}}$ 9D01 01 13P483 G1/4 5,5 9D01 01 17P483 G3/8 5,5 9D01 01 21P483 G1/2 5,5 9D01 02 13P483 G1/4 8 9D01 02 17P483 G3/8 8 9D01 02 21P483 G1/2 8	 Transair® C $\overline{\text{DN}}$ 9D14 01 13P483 G1/4 5,5 9D14 01 17P483 G3/8 5,5 9D14 01 21P483 G1/2 5,5 9D14 02 13P483 G1/4 8 9D14 02 17P483 G3/8 8 9D14 02 21P483 G1/2 8 9D14 03 17P483 G3/8 11 9D14 03 21P483 G1/2 11	 Transair® $\overline{\text{DN}}$ 9D21 01 06P483 6 5,5 9D21 01 08P483 8 5,5 9D21 01 09P483 9 5,5 9D21 01 13P483 13 5,5 9D21 02 10P483 10 8 9D21 02 13P483 13 8 9D21 03 13P483 13 11 9D21 03 16P483 16 11
ISO C 6 mm Single shut-off	 Transair® C $\overline{\text{DN}}$ 9D01 01 13P183 G1/4 5,5 9D01 01 17P183 G3/8 5,5 9D01 01 21P183 G1/2 5,5	 Transair® C $\overline{\text{DN}}$ 9D14 01 13P183 G1/4 5,5 9D14 01 17P183 G3/8 5,5	 Transair® $\overline{\text{DN}}$ 9D21 01 10P183 10 5,5

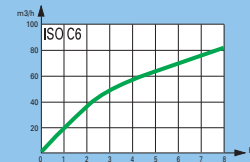
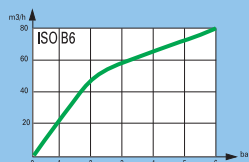
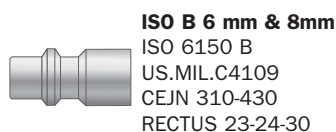







> Working temperature :

- models ISO B 6, 8 mm safety version : from -20°C to +90°C
- models ISO C 6, 8 and 11 mm safety version : from -20°C to +60°C
- models ISO C 6 mm single shut-off version : from -20°C to +60°C

> Max. working pressure :

- models ISO B 6 and 8 mm safety version : 16 bar
- models ISO C 6, 8 and 11 mm safety version : respectively 12, 10 and 8 bar
- models ISO C 6 mm single shut-off version : 10 bar

<p>ISO B 6 8 mm</p>		<p>Male threaded BSP parallel</p> <p>Transair® C $\overline{\text{DN}}$</p> <table border="1"> <tr><td>9084 23 13TR</td><td>R1/4</td><td>5,5</td></tr> <tr><td>9084 23 17TR</td><td>R3/8</td><td>5,5</td></tr> <tr><td>9084 30 13TR</td><td>R1/4</td><td>8</td></tr> <tr><td>9084 30 17TR</td><td>R3/8</td><td>8</td></tr> <tr><td>9084 30 21TR</td><td>R1/2</td><td>8</td></tr> </table>	9084 23 13TR	R1/4	5,5	9084 23 17TR	R3/8	5,5	9084 30 13TR	R1/4	8	9084 30 17TR	R3/8	8	9084 30 21TR	R1/2	8		<p>Female probe BSP parallel</p> <p>Transair® C $\overline{\text{DN}}$</p> <table border="1"> <tr><td>9086 23 13TR</td><td>G1/4</td><td>5,5</td></tr> <tr><td>9086 23 17TR</td><td>G3/8</td><td>5,5</td></tr> <tr><td>9086 30 13TR</td><td>G1/4</td><td>8</td></tr> <tr><td>9086 30 17TR</td><td>G3/8</td><td>8</td></tr> <tr><td>9086 30 21TR</td><td>G1/2</td><td>8</td></tr> </table>	9086 23 13TR	G1/4	5,5	9086 23 17TR	G3/8	5,5	9086 30 13TR	G1/4	8	9086 30 17TR	G3/8	8	9086 30 21TR	G1/2	8		<p>Probe with hosetail</p> <p>Transair® ØD $\overline{\text{DN}}$</p> <table border="1"> <tr><td>9085 23 06TR</td><td>6</td><td>5,5</td></tr> <tr><td>9085 23 08TR</td><td>8</td><td>5,5</td></tr> <tr><td>9085 23 10TR</td><td>10</td><td>5,5</td></tr> <tr><td>9085 30 08TR</td><td>8</td><td>8</td></tr> <tr><td>9085 30 10TR</td><td>10</td><td>8</td></tr> <tr><td>9085 30 13TR</td><td>13</td><td>8</td></tr> </table>	9085 23 06TR	6	5,5	9085 23 08TR	8	5,5	9085 23 10TR	10	5,5	9085 30 08TR	8	8	9085 30 10TR	10	8	9085 30 13TR	13	8																																				
9084 23 13TR	R1/4	5,5																																																																																								
9084 23 17TR	R3/8	5,5																																																																																								
9084 30 13TR	R1/4	8																																																																																								
9084 30 17TR	R3/8	8																																																																																								
9084 30 21TR	R1/2	8																																																																																								
9086 23 13TR	G1/4	5,5																																																																																								
9086 23 17TR	G3/8	5,5																																																																																								
9086 30 13TR	G1/4	8																																																																																								
9086 30 17TR	G3/8	8																																																																																								
9086 30 21TR	G1/2	8																																																																																								
9085 23 06TR	6	5,5																																																																																								
9085 23 08TR	8	5,5																																																																																								
9085 23 10TR	10	5,5																																																																																								
9085 30 08TR	8	8																																																																																								
9085 30 10TR	10	8																																																																																								
9085 30 13TR	13	8																																																																																								
<p>ISO C 6 8 11 mm</p>		<p>Male probe BSP parallel</p> <p>Transair® C $\overline{\text{DN}}$</p> <table border="1"> <tr><td>9A87 01 10X099</td><td>G1/8</td><td>5,5</td></tr> <tr><td>9A87 01 13X099</td><td>G1/4</td><td>5,5</td></tr> <tr><td>9A87 01 17X099</td><td>G3/8</td><td>5,5</td></tr> <tr><td>9A87 02 13X099</td><td>G1/4</td><td>8</td></tr> <tr><td>9A87 02 17X099</td><td>G3/8</td><td>8</td></tr> <tr><td>9A87 02 21X099</td><td>G1/2</td><td>8</td></tr> <tr><td>9A87 03 17X099</td><td>G3/8</td><td>11</td></tr> <tr><td>9A87 03 21X099</td><td>G1/2</td><td>11</td></tr> </table>	9A87 01 10X099	G1/8	5,5	9A87 01 13X099	G1/4	5,5	9A87 01 17X099	G3/8	5,5	9A87 02 13X099	G1/4	8	9A87 02 17X099	G3/8	8	9A87 02 21X099	G1/2	8	9A87 03 17X099	G3/8	11	9A87 03 21X099	G1/2	11		<p>Female probe BSP parallel</p> <p>Transair® C $\overline{\text{DN}}$</p> <table border="1"> <tr><td>9A86 01 10X099</td><td>G1/8</td><td>5,5</td></tr> <tr><td>9A86 01 13X099</td><td>G1/4</td><td>5,5</td></tr> <tr><td>9A86 01 17X099</td><td>G3/8</td><td>5,5</td></tr> <tr><td>9A86 01 21X099</td><td>M14x1,25</td><td>5,5</td></tr> <tr><td>9A86 02 13X099</td><td>G1/4</td><td>8</td></tr> <tr><td>9A86 02 17X099</td><td>G3/8</td><td>8</td></tr> <tr><td>9A86 02 21X099</td><td>G1/2</td><td>8</td></tr> <tr><td>9A86 03 17X099</td><td>G3/8</td><td>11</td></tr> <tr><td>9A86 03 21X099</td><td>G1/2</td><td>11</td></tr> </table>	9A86 01 10X099	G1/8	5,5	9A86 01 13X099	G1/4	5,5	9A86 01 17X099	G3/8	5,5	9A86 01 21X099	M14x1,25	5,5	9A86 02 13X099	G1/4	8	9A86 02 17X099	G3/8	8	9A86 02 21X099	G1/2	8	9A86 03 17X099	G3/8	11	9A86 03 21X099	G1/2	11		<p>Probe with hosetail</p> <p>Transair® ØD $\overline{\text{DN}}$</p> <table border="1"> <tr><td>9A94 01 06X099</td><td>6</td><td>5,5</td></tr> <tr><td>9A94 01 08X099</td><td>8</td><td>5,5</td></tr> <tr><td>9A94 01 10X099</td><td>10</td><td>5,5</td></tr> <tr><td>9A94 01 13X099</td><td>13</td><td>5,5</td></tr> <tr><td>9A94 02 06X099</td><td>6</td><td>8</td></tr> <tr><td>9A94 02 08X099</td><td>8</td><td>8</td></tr> <tr><td>9A94 02 10X099</td><td>10</td><td>8</td></tr> <tr><td>9A94 02 13X099</td><td>13</td><td>8</td></tr> <tr><td>9A94 03 08X099</td><td>8</td><td>11</td></tr> <tr><td>9A94 03 13X099</td><td>13</td><td>11</td></tr> <tr><td>9A94 03 16X099</td><td>16</td><td>11</td></tr> </table>	9A94 01 06X099	6	5,5	9A94 01 08X099	8	5,5	9A94 01 10X099	10	5,5	9A94 01 13X099	13	5,5	9A94 02 06X099	6	8	9A94 02 08X099	8	8	9A94 02 10X099	10	8	9A94 02 13X099	13	8	9A94 03 08X099	8	11	9A94 03 13X099	13	11	9A94 03 16X099	16	11
9A87 01 10X099	G1/8	5,5																																																																																								
9A87 01 13X099	G1/4	5,5																																																																																								
9A87 01 17X099	G3/8	5,5																																																																																								
9A87 02 13X099	G1/4	8																																																																																								
9A87 02 17X099	G3/8	8																																																																																								
9A87 02 21X099	G1/2	8																																																																																								
9A87 03 17X099	G3/8	11																																																																																								
9A87 03 21X099	G1/2	11																																																																																								
9A86 01 10X099	G1/8	5,5																																																																																								
9A86 01 13X099	G1/4	5,5																																																																																								
9A86 01 17X099	G3/8	5,5																																																																																								
9A86 01 21X099	M14x1,25	5,5																																																																																								
9A86 02 13X099	G1/4	8																																																																																								
9A86 02 17X099	G3/8	8																																																																																								
9A86 02 21X099	G1/2	8																																																																																								
9A86 03 17X099	G3/8	11																																																																																								
9A86 03 21X099	G1/2	11																																																																																								
9A94 01 06X099	6	5,5																																																																																								
9A94 01 08X099	8	5,5																																																																																								
9A94 01 10X099	10	5,5																																																																																								
9A94 01 13X099	13	5,5																																																																																								
9A94 02 06X099	6	8																																																																																								
9A94 02 08X099	8	8																																																																																								
9A94 02 10X099	10	8																																																																																								
9A94 02 13X099	13	8																																																																																								
9A94 03 08X099	8	11																																																																																								
9A94 03 13X099	13	11																																																																																								
9A94 03 16X099	16	11																																																																																								

Single shut-off

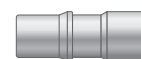

ISO C 6 mm
ISO 6150 C
NF E49-053
CEJN 291
RECTUS 18-84

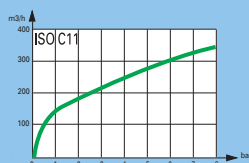
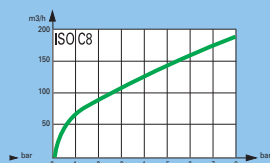

Single shut-off

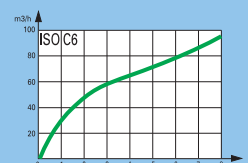

> Connection accessories

- > Offering many possible configurations in BSP parallel and taper
- > For connection to ancillary equipment on wall brackets or assembly brackets
- > For compressor outlets, dryers or receivers

- > Suitable fluids : compressed air, vacuum, argon, nitrogen (please consult us for other fluids)
- > Max. working pressure : 16 bar
- > Vacuum : 98,7% (13 mbar absolute pressure)
- > Working temperature : -10°C to +80°C

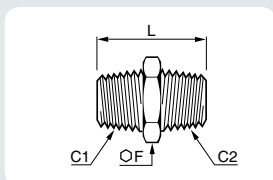

Straight male BSPT equal/unequal adaptor

Transair®	C1	C2	F	L
EF00 00 02	R1/4	R1/4	14	27
EF00 02 03	R1/4	R3/8	17	27,5
EF00 00 03	R3/8	R3/8	17	28
EF00 02 04	R1/4	R1/2	22	30,5
EF00 03 04	R3/8	R1/2	22	31
EF00 00 04	R1/2	R1/2	22	33,5
EF00 04 06	R1/2	R3/4	27	37,5
EF00 00 06	R3/4	R3/4	27	40
EF00 06 08	R3/4	R1"	34	43
EF00 00 08	R1"	R1"	34	45,5
EF00 08 10	R1"	R1"1/4	42	40,5
EF00 00 10	R1"1/4	R1"1/4	42	43
EF00 10 12	R1"1/4	R1"1/2	48	44
EF00 10 16	R1"1/4	R2"	60	49
EF00 00 12	R1"1/2	R1"1/2	48	44
EF00 12 16	R1"1/2	R2"	60	49
EF00 12 20	R1"1/2	R2"1/2	75	52,5
EF00 00 16	R2"	R2"	60	52
EF00 16 20	R2"	R2"1/2	75	54,5
EF00 00 20	R2"1/2	R2"1/2	75	58

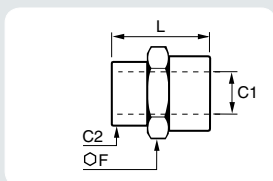

Straight female BSPP equal/unequal adaptor

Transair®	C1	C2	F	L
EF02 01 02	G1/8	G1/4	17	19,5
EF02 00 02	G1/4	G1/4	17	22
EF02 01 03	G1/8	G3/8	22	20
EF02 02 03	G1/4	G3/8	22	23
EF02 00 03	G3/8	G3/8	22	24
EF02 02 04	G1/4	G1/2	27	27
EF02 03 04	G3/8	G1/2	27	27,5
EF02 00 04	G1/2	G1/2	27	30
EF02 04 06	G1/2	G3/4	30	30
EF02 00 06	G3/4	G3/4	30	32

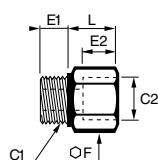

Increaser male BSPT to female BSPP

Transair®	C1	C2	E1	E2	F	L
EF06 01 02	R1/8	G1/4	6	11,5	17	14
EF06 01 03	R1/8	G3/8	6	11,5	22	14,5
EF06 00 02	R1/4	G1/4	8	11,5	17	14
EF06 02 03	R1/4	G3/8	8	11,5	22	14,5
EF06 02 04	R1/4	G1/2	8	15	27	18
EF06 00 03	R3/8	G3/8	9	11,5	22	14,5
EF06 03 04	R3/8	G1/2	9	15	27	18
EF06 00 04	R1/2	G1/2	10	15	27	18
EF06 04 06	R1/2	G3/4	11,5	10,5	29	24
EF06 04 08	R1/2	G1"	11,5	12	36	26,5
EF06 00 06	R3/4	G3/4	13	10,5	29	25,5
EF06 06 08	R3/4	G1"	13	12,5	36	28
EF06 00 08	R1"	G1"	15	12,5	36	30
EF06 08 10	R1"	G1"1/4	15	14	45	32
EF06 00 10	R1"1/4	G1"1/4	17,5	14	45	34,5
EF06 10 12	R1"1/4	G1"1/2	17,5	15	52	35,5
EF06 10 16	R1"1/4	G2"	17,5	16	64	36,5
EF06 00 12	R1"1/2	G1"1/2	17,5	15	52	35,5
EF06 12 16	R1"1/2	G2"	17,5	16	64	36,5
EF06 12 20	R1"1/2	G2"1/2	17,5	19	80	39,5
EF06 00 16	R2"	G2"	20,5	16	64	39,5
EF06 16 20	R2"	G2"1/2	20,5	19	80	42,5
EF06 00 20	R2"1/2	G2"1/2	23	19	80	45

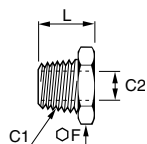

Reducer male BSPT to female BSPP

Transair®	C1	C2	F	L
EF04 01 02	R1/4	G1/8	14	16
EF04 01 03	R3/8	G1/8	17	16,5
EF04 02 03	R3/8	G1/4	17	16,5
EF04 02 04	R1/2	G1/4	22	19,5
EF04 03 04	R1/2	G3/8	22	19,5
EF04 03 06	R3/4	G3/8	27	23,5
EF04 04 06	R3/4	G1/2	27	23,5

> Connections accessories

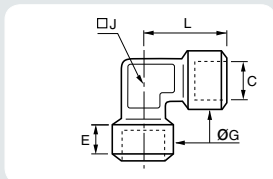

Equal female elbow BSPP

Transair®	C	€	G	J	L
EF12 00 02	G1/4	11	17	13	25,5
EF12 00 03	G3/8	11,5	21	17	28
EF12 00 04	G1/2	14	26	21	33,5
EF12 00 06	G3/4	15	31	27	36,5

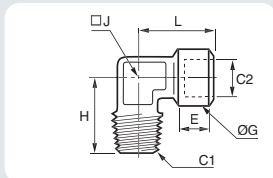

Equal female stud elbow BSPP, male BSPT

Transair®	C1	C2	€	G	H	J	L
EF13 00 02	R1/4	G1/4	11	17	23,5	13	25,5
EF13 00 03	R3/8	G3/8	11,5	21	26	17	28
EF13 00 04	R1/2	G1/2	14	26	31	21	33,5
EF13 00 06	R3/4	G3/4	15	31	35	27	36,5

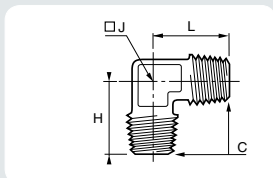

Equal male stud elbow BSPT

Transair®	C	H	J	L
EF14 00 02	R1/4	23,5	13	23,5
EF14 00 03	R3/8	26	17	26
EF14 00 04	R1/2	31	21	31
EF14 00 06	R3/4	35	27	35

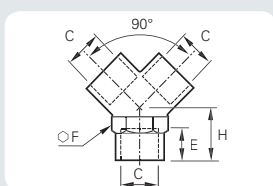

Equal Y female BSPP

Transair®	C	€	F	H
EF10 00 02	G1/4	11	17	14
EF10 00 03	G3/8	11,5	20	16
EF10 00 04	G1/2	14	25	19

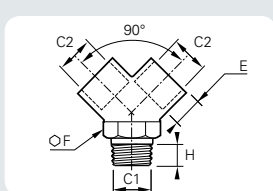

Equal Y female BSPP, male BSPT

Transair®	C1	C2	€	F	H
EF11 00 04	R1/2	G1/2	14	25	19

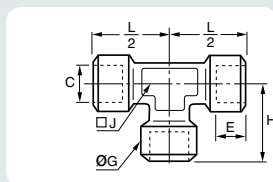

Equal female tee BSPP

Transair®	C	€	G	H	J	L/2
EF15 00 02	G1/4	11	17	25,5	13	25,5
EF15 00 03	G3/8	11,5	21	28	17	28
EF15 00 04	G1/2	14	26	33,5	21	33,5
EF15 00 06	G3/4	15	31	36,5	27	36,5

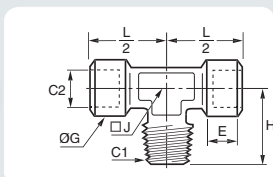

Male stud branch tee, female BSPP, male BSPT

Transair®	C1	C2	€	G	H	J	L/2
EF16 00 02	R1/4	G1/4	17	17	23,5	13	25,5
EF16 00 03	R3/8	G3/8	11,5	21	26	17	28
EF16 00 04	R1/2	G1/2	14	26	31	21	33,5
EF16 00 06	R3/4	G3/4	15	31	35	27	36,5

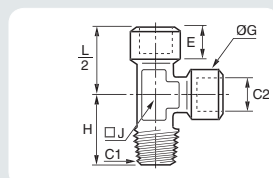

Male stud run tee, female BSPP, male BSPT

Transair®	C1	C2	€	G	H	J	L/2
EF17 00 02	R1/4	G1/4	11	17	23,5	13	25,5
EF17 00 03	R3/8	G3/8	11,5	21	26	17	28
EF17 00 04	R1/2	G1/2	14	26	31	21	33,5
EF17 00 06	R3/4	G3/4	15	31	36,5	27	36,5

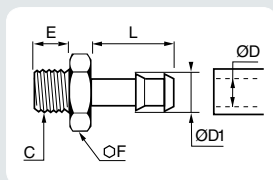

Tailpiece adaptor for PVC hose male BSPP

Transair®	ØD	ØD1	C	€	F	L
EF26 06 01	6	7	G1/8	6	12	20
EF26 06 02	6	7	G1/4	8	17	21
EF26 08 02	8	9	G1/4	8	17	21
EF26 08 03	8	9	G3/8	9	19	21
EF26 10 02	10	12	G1/4	8	14	20
EF26 10 03	10	12	G3/8	9	19	20
EF26 10 04	10	12	G1/2	10	22	20
EF26 13 02	13	15	G1/4	8	17	21
EF26 13 03	13	15	G3/8	9	19	22
EF26 13 04	13	15	G1/2	10	24	25
EF26 16 03	16	18	G3/8	9	19	21
EF26 16 04	16	18	G1/2	10	24	25

Supplied with captive sealing washer.
Ideally suited for use with Transair® PVC hose.

> FRLs, automatic drains and accessories

Transair® FRLs are ideal for general purpose use and can be fitted downstream of the compressed air installation and at the take-off point on workstations and machines.

- > Air quality at FRL inlet : dry, damp, lubricated
- > Transair® FRL products are guaranteed silicone free

- > Chemical resistance to compressor oils
To convert Nm³/h to cfm use a coefficient of 0.588



Filter regulator

Transair®	C	Recommended flow	Bowl capacity	Max. inlet pressure	Max. outlet pressure	T°C at IO bar	Filtration	Associated gauge
6700 00 13	G1/4	33m ³ /h	22cm ³	16 bar	8 bar	0°C to +50°C	30 µm	6798 00 05
6700 00 21	G1/2	114m ³ /h	50cm ³	16 bar	8 bar	0°C to +50°C	30 µm	6798 00 06

Semi-automatic condensate drainage



Pressure regulator

Transair®	C	Recommended flow	Max. inlet pressure	Max. outlet pressure	Temperature	Associated gauge
6701 00 13	G1/4	33m ³ /h	16 bar	8 bar	0°C to +60°C	6798 00 05
6701 00 21	G1/2	114m ³ /h	16 bar	8 bar	0°C to +60°C	6798 00 06



Filter regulator lubricator set

Transair®	C	Recommended flow	Bowl capacity	Max. inlet pressure	Max. outlet pressure	T°C at IO bar	Filtration	Associated gauge
6707 00 13	G1/4	33m ³ /h	22cm ³	16 bar	8 bar	0°C to +50°C	30 µm	6798 00 05
6707 00 21	G1/2	114m ³ /h	50cm ³	16 bar	8 bar	0°C to +50°C	30 µm	6798 00 06

Semi-automatic condensate drainage

All these products can be easily connected to Transair® compressed air pipework systems using the following Transair® stud fittings :

-6605 17 13 for G1/4 port

-6605 17 21 or 6605 25 21 for G1/2 port



Filter regulator and lubricator with gauge

Transair®	C	Recommended flow	Bowl capacity	Max. inlet pressure	Max. outlet pressure	T°C at IO bar	Filtration
6708 00 13	G1/4	33m³/h	22cm³	16 bar	8 bar	0°C to +50°C	30 µm
6708 00 21	G1/2	114m³/h	50cm³	16 bar	8 bar	0°C to +50°C	30 µm

Semi-automatic condensate drainage



Filter separator

Transair®	C	Recommended flow	Bowl capacity	Max. inlet pressure	Max. outlet pressure	T°C at IO bar	Filtration
6702 00 13	G1/4	33m³/h	22cm³	16 bar	8 bar	0°C to +50°C	30 µm
6702 00 21	G1/2	114m³/h	50cm³	16 bar	8 bar	0°C to +50°C	30 µm

Semi-automatic condensate drainage



Oil mist lubricator

Transair®	C	Max. inlet pressure	Max. outlet pressure	T°C at IO bar	Oil capacity
6703 00 13	G1/4	16 bar	8 bar	0°C to +50°C	45cm³
6703 00 21	G1/2	16 bar	8 bar	0°C to +50°C	112cm³

Oil mist lubricator

Semi-automatic condensate drainage

> FRLs, automatic drains and accessories



Automatic drain

Transair®

C

6706 00 21

G1/2

Automatic condensate drain with float



3/2 in-line vent valve

Transair®

C

Recommended
flow

Min.
pressure

Max.
pressure

6704 00 13

G1/4

33m³/h

0 bar

16 bar

6704 00 21

G1/2

114m³/h

0 bar

16 bar

Downstream circuit drains when valve is closed.
Supplied without padlock.



Front and rear port connector block

Transair®

C

6705 00 13

G1/4

6705 00 21

G1/2

To be used when assembling 2 elements front and rear entry G1/8 and G1/4.
Can also be used when oil-free air is required – install prior to lubricator



Pressure gauge

Transair®	C	Face Ø mm	Associated FRL
6798 00 05	G1/8	40	6700 00 13 - 6701 00 13 - 6707 00 13
6798 00 06	G1/4	50	6700 00 21 - 6701 00 21 - 6707 00 21

To be mounted on the front face of filter regulator 6700, regulator 6701 and filter regulator lubricator set 6707.



Protection bowl

Transair®	C
6798 00 07	G1/4
6798 00 08	G1/2

To be used with filter regulator, filter separator and filter regulator lubricator set. Equipped with snap mounting.



Mounting brackets

Transair®	C
6798 00 01	G1/4
6798 00 02	G1/2

For wall or machine fixing.
Screws supplied
Wall fixing-to-centre : 46 mm (compatible with Transair® fixing clips).



Assembly kit

Transair®	C
6798 00 03	G1/4
6798 00 04	G1/2

To join separate FRL units.

EASIER

HANDLING

Pipes and fittings are supplied ready for immediate installation
> NO PREPARATION REQUIRED

Quick assembly - no need to weld, glue or crimp
> TIME SAVING

Easy to assemble
> NO IN-DEPTH TRAINING REQUIRED



COMPLETELY ADAPTABLE

> Dismountable and reusable components

HIGH RESISTANCE TO

- > corrosion
- > aggressive environments
- > mechanical shocks
- > thermal variations
- > U.V.
- > compressor oil carry over

> Installation guide

	Essential instructions	
	Installation instructions	60
	Sound engineering practice for the optimization of an air pipework system	61
	Aluminium pipe	
	General	62
	Aluminium pipe section	64
	Pipe-to-pipe and stud connectors	
	General	68
	Connection / disconnection	70
	Practical examples	73
	Do's / Don'ts	78/79
	Quick assembly brackets	
	General	80
	Fitting a quick assembly bracket	81
	Practical examples	84
	Flexible hose	
	General	86
	Network connection	87
	Do's / Don'ts	90
	Air distribution columns	
	Installation	91
	Fixture accessories	
	Attachments	92
	Supporting a Transair® system	94
	Practical data	
	Z dimensions	98
	Expansion / contraction	99
	Conversion charts	104
	Transair® in situ	106

> The golden rules of installation

> Installation instructions

> General

Prior to the installation of a Transair® compressed air distribution system, the installer should ensure that the installation area complies with any regulations applicable to areas exposed to explosive hazards (in particular the effect of static electricity in a silo area). Transair® should be installed downstream of the compressed air receiver, or after the dryer. Flexible Transair® hose can be installed at the start of the system in order to eliminate any sources of vibration and to facilitate maintenance operations. When maintaining or modifying a Transair® system, the relevant section should be vented prior to the commencement of any work. Installers should use only Transair® components and accessories, in particular Transair® pipe clips and fixture clamps. The technical properties of the Transair® components, as described in the Transair® catalogue, must be respected.

> Commissioning the installation

Once the Transair® installation has been installed and prior to commissioning, the installer should complete all tests, inspections and compliance checks as stated in any contract and according to sound engineering practice and current local regulations.

> Transair® pipe and hoses

Transair® pipe should be protected from mechanical impact, particularly if exposed to collision with fork-lift trucks or when sited in an environment with moving overhead loads. Similarly, rotation of the pipe and pipe supports should be avoided. Transair® pipe must not be welded.

Flexible Transair® hoses should be used in accordance with the recommendations of the installation guidelines.

NB: In certain situations, Transair® aluminium pipe may be formed with a bend - please contact us for further information.

> Expansion / contraction

Expansion and contraction of the system are automatically catered for by correct installation. The system designer and installer should calculate the elongation or retraction of each Transair® line according to the recommendations in this installation guide.

> Component assembly

Transair® components are provided with assembly instructions for their correct use - simply follow the methods and recommendations stated in this document.

> Transair® installations - situations to avoid

> installation within a solid mass (concrete, foam, etc.), especially underground

> the hanging of any external equipment to Transair® pipe

> the use of Transair® for earthing, or as a support for electrical equipment

> exposure to chemicals that are incompatible with Transair® components (please contact us for further details).

> Sound engineering practice for the optimization of an air pipework system

> When installing a Transair® system, the work should be performed in accordance with good engineering practice.

> Bends and bypasses represent sources of pressure drop
To avoid excessive pressure loss, use modular consoles to offset the network and to bypass obstacles.
Keep in-line pipe diameter reductions to a minimum.

> Maintain a consistent level of good quality air by use of adequate filtration at the compressor outlet.

> The diameter of the pipe will influence pressure drop and the operation of point-of-use equipment
Select the diameter according to the required flow rate and acceptable pressure drop at the point of use.

> Never encase the network in order to facilitate maintenance or servicing.

> Position drops as close as possible to the point of use.

> Transair® aluminium pipe

> General

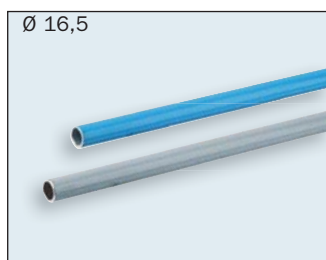

Ø 16,5
Deburred and chamfered pipe

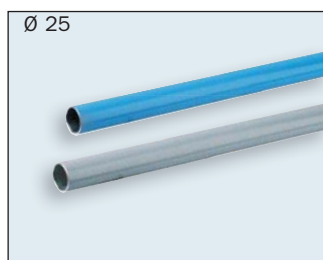

Ø 25
Deburred and chamfered pipe

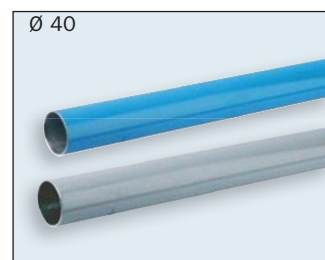

Ø 40
Deburred and chamfered pipe



Ø 63
Pipe pre-drilled at each end with two 22 mm diameter holes, deburred and chamfered



Ø 76
Pipe lugged at each end, deburred and chamfered

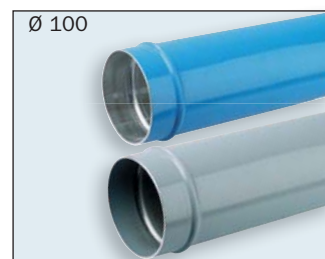

Ø 100
Pipe lugged at each end, deburred and chamfered

> Presentation

Transair® aluminium pipe is supplied «ready for use».

No particular preparation (cutting, deburring, chamfering, etc.) is required.

Thanks to the rigidity of Transair® aluminium pipe, temperature-related expansion / contraction phenomena are reduced to a minimum. The Transair® network retains its straightness, and hence its performance, over time (reduction of pressure drop caused by surface friction).

Transair® aluminium pipe is calibrated and fits perfectly with all Transair® components. Each connection is automatically secured and the seal is optimized.

The use of Transair® aluminium pipe minimises corrosion to the internal surface (self-protection of the pipe by the formation of alumina oxide).

Transair® aluminium pipe has a protective lacquer coating (QUALICOAT certified) and is thus protected from external aggression. It's colour allows the network to be immediately identified and gives a clean and aesthetic overall appearance.

Standard colours available:

- blue (RAL 5012/BS1710)
- grey (RAL 7001)

(please contact us for other colours)

Transair® aluminium pipe is available in 6 diameters and 2 lengths: 3 metres and 6 metres (please contact us for other lengths).

> Applications

Transair® Ø 16.5 - Ø 25 - Ø 40 - Ø 63 - Ø 76 - Ø 100 aluminium pipe has been specially designed for the creation of primary and secondary networks for compressed air, vacuum and neutral gases (argon, nitrogen) - please contact us for other fluids

> Marking

Pipe calibration is a guarantee of secure connection and sealing

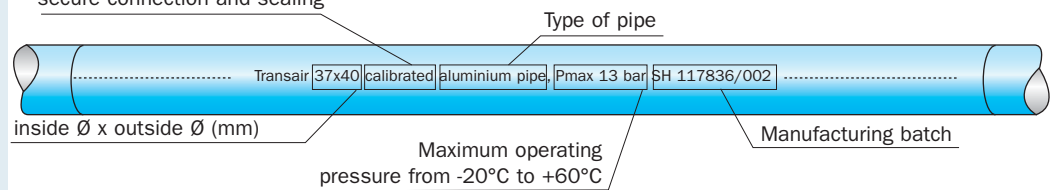

> Identification

The transported fluid can be instantly identified by the colour of the pipe

Blue pipe → compressed air network
 Grey pipe → vacuum network

This identification may also be done by applying adhesive labels directly onto the pipe

AIR / LUFT / AERE

VIDE / VACUUM / VACIO

> Connection indicator

Only on Ø 16.5 - Ø 25 - Ø 40 aluminium pipe

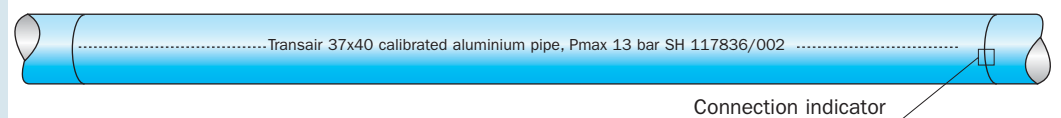

> Drilling locator : «mark» lines for correct drilling

Only on Ø 16.5 - Ø 25 - Ø 40 - Ø 63 aluminium pipe

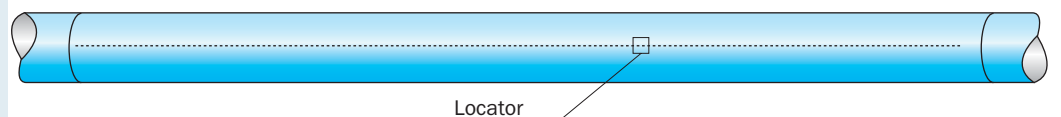

Drilling locators are used to correctly position Transair® brackets onto the pipe. There are two locators on each pipe. The second locator is used to position a second bracket perpendicular to a first bracket.

> Transair® aluminium pipe

> Aluminium pipe section

> Ø 16,5
Ø 25 - Ø 40

> Tools

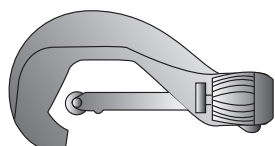

Pipe cutter for aluminium pipe
ref. 6698 03 01



Chamfer tool for aluminium pipe
ref. 6698 04 01



Deburring tool for aluminium pipe
ref. 6698 04 02



Marking tool for aluminium pipe
ref. 6698 04 03

> Procedure

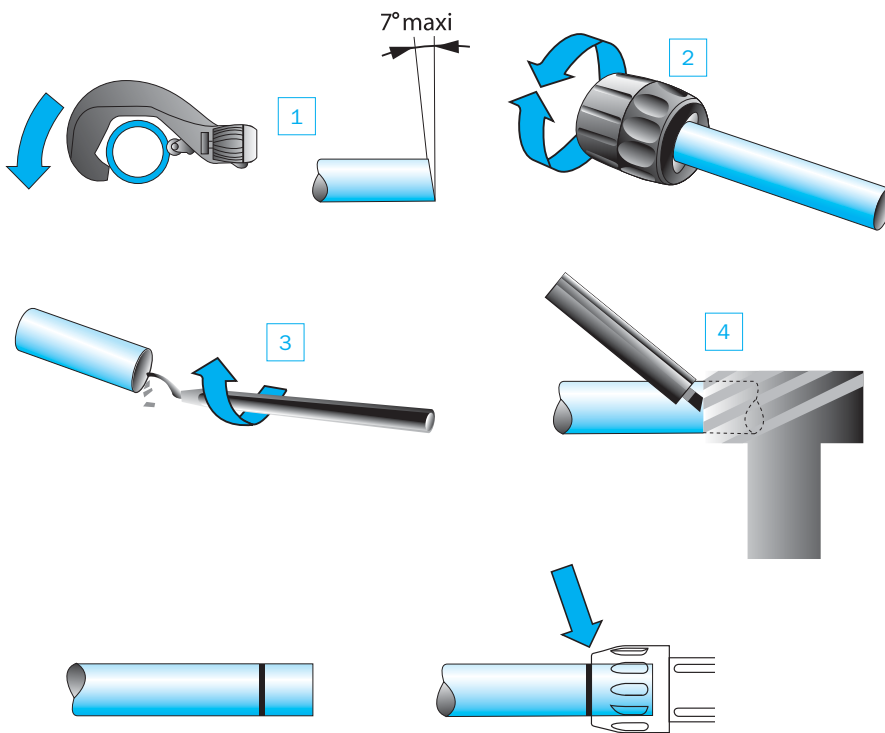

- 1 - Cutting the pipe :
- place the pipe in the pipe cutter
 - position the blade onto the pipe
 - rotate the pipe cutter around the pipe while gently tightening the wheel.

- 2 - Carefully chamfer the outer edges.
3 - Also deburr the inner end of the pipe
4 - Trace the connection indicator using the marking tool.

The insertion lengths for Ø 16,5 - Ø 25 - Ø 40 connectors are 25 mm, 27 mm and 45 mm respectively, with the exception of the end cap, ref. 6625, for which the insertion lengths are of 39 mm, 42 mm and 64 mm respectively.

> Ø 63

> Tools

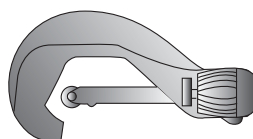

Pipe cutter for aluminium pipe
ref. 6698 03 01



File



Deburring tool for aluminium pipe
ref. 6698 04 02

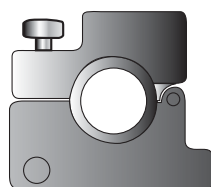

Drilling jig for aluminium pipe
ref. 6698 01 02



Drilling tool for aluminium pipe
ref. 6698 02 01

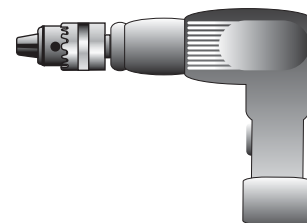

Drill

> Procedure

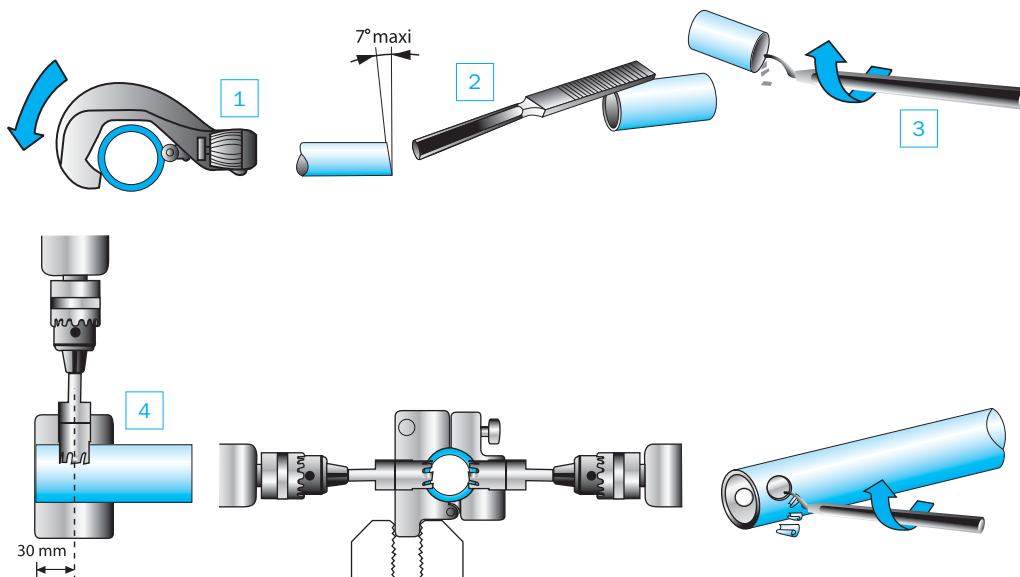

- 1 - Cutting the pipe :
 - place the pipe in the pipe cutter
 - position the blade on the pipe
 - rotate the pipe cutter around the pipe while gently tightening the wheel.
- 2 - Carefully chamfer the outer edges.
- 3 - Also deburr the inner end of the pipe

- 4 - Drill the two clamp holes using the drilling jig (6698 01 02) and the Ø 22 mm drilling tool (6698 02 01). Loosen the jig, release the pipe, then deburr both holes. Ensure that all outer and inner surfaces are smooth and clear of swarf and potential sharp edges.

> Transair® aluminum pipe

> Aluminum pipe section

> Ø 76 - Ø 100

> Tools

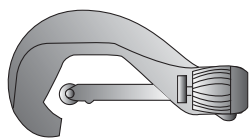

Pipe cutter for aluminium pipe ref. EW08 00 01

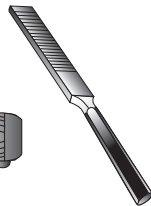

File



Portable tool kit ref. EW01 00 01 (220V) or EW01 00 03 (110V)



Pipe forming jaw set ref. EW02 L1 00 (Ø 76) or EW02 L3 00 (Ø 100)

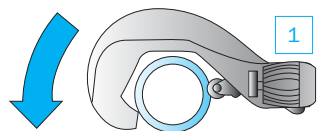

- 1 - Cutting the pipe :
- place the pipe in the pipe cutter
 - position the blade on the pipe
 - rotate the pipe cutter around the pipe while gently tightening the wheel.

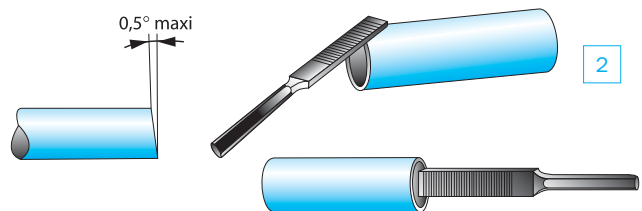

- 2 - Carefully deburr and chamfer the outer and inner edges of the pipe with a file.

> Procedure



Open the retaining pin at the front of the machine by pressing the jaw release button*



Place the jaws in the housing.



Lock in position by closing the retaining pin.

3 - Creating the lugs for Ø 76 or Ø 100 cut pipe

> Procedure

3

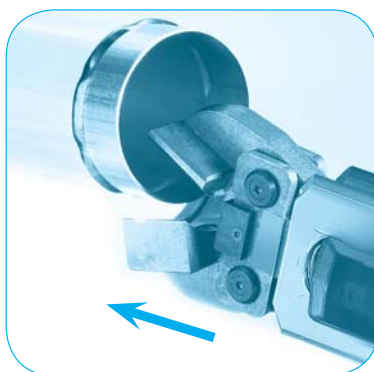

Manually open the jaws of the clamp and insert the aluminium pipe into the clamp as far as it will go.

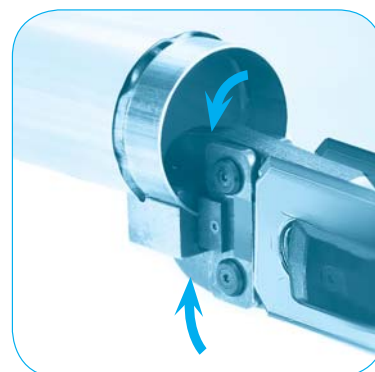

Release the jaws. Press the trigger and crimp the tube until a 'snap' sound is heard.

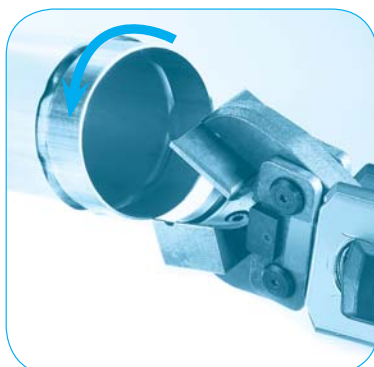

Re-open the two jaws to remove the pipe and rotate the pipe slightly.

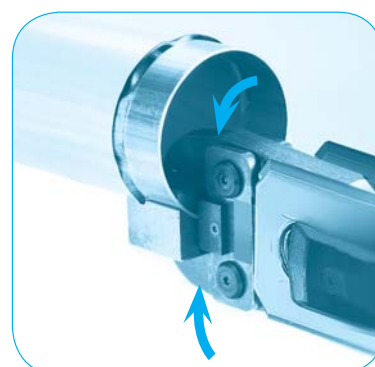

Renew the operation until the required minimum number of lugs for each diameter is achieved.

	Ø 76	Ø 100
Min. number of lugs	6	7

Important: do not overlap the lugs!

> General

> Ø 16,5
Ø 25
Ø 40

Instant connection by means of a gripping ring

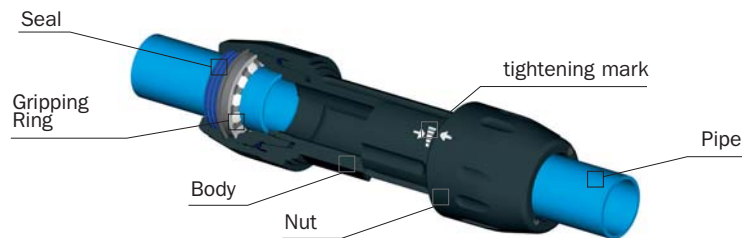

Ø 16,5, Ø 25 and Ø 40 connectors secure instantly to Transair® aluminum pipe. Simply insert the pipe into the connector up to the connector insertion mark.

The internal gripping ring is then automatically secured and the connection is complete.

> Ø 63

Double clamp quick-fit connection



Ø 63 connectors are quickly secured to Transair® aluminum pipe by means of a double clamp which makes the connector

fully integrated with the pipe. Connection is achieved by simply tightening the nut.

> Ø 76
Ø 100

Clamp quick-fit connection

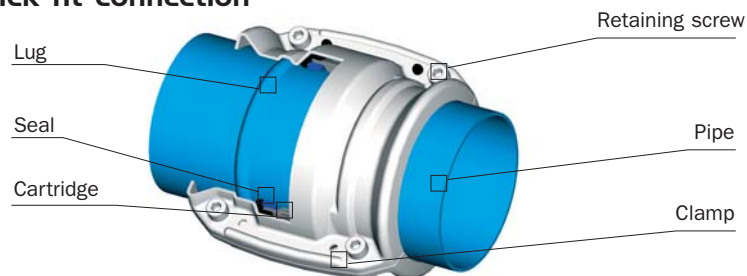

Ø 76 and Ø 100 clamps secure instantly to Transair® aluminium pipe. Simply position the formed pipe within the Transair® cartridge, which acts as a

seal. Close the Transair® clamp to secure the connection and finally tighten the 4 retaining screws.

There are important visual markings on the bodies and nuts of Transair® Ø 16,5, Ø 25 and Ø 40 connectors. These are represented by solid and empty arrows and indicate the optimum torque.

When assembling Transair® connectors,

the nuts are tightened to a pre-defined torque on the body of the connector. This torque guarantees the seal and safety of each connection.

There is no need to loosen the nuts prior to joining Ø 16,5, Ø 25 and Ø 40 connectors to Transair® aluminum pipe.

> **Pre-assembled tightening indicators for Ø 16,5, Ø 25 and Ø 40 connectors.**

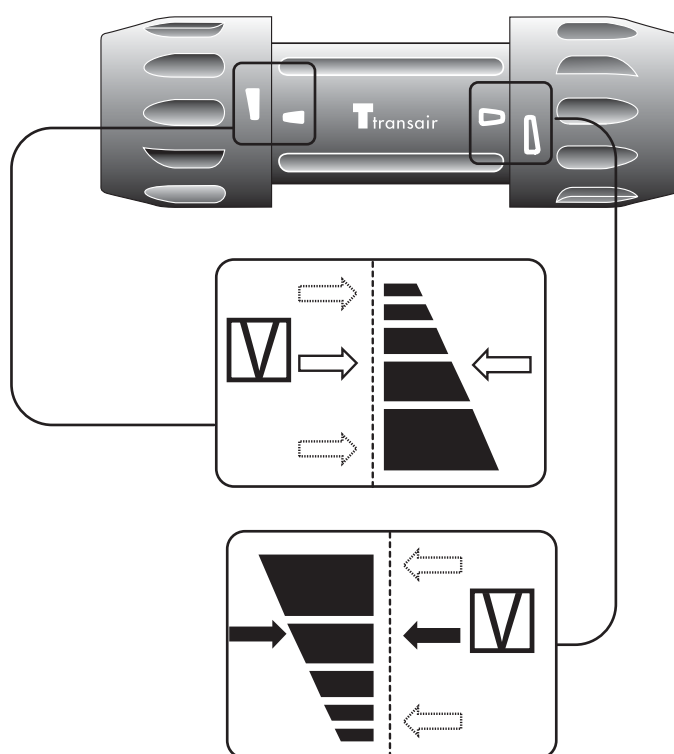

Before using Ø 16,5, Ø 25 or Ø 40 connectors, ensure that these arrow marks are correctly aligned with each other.

> Connection / disconnection

Connection

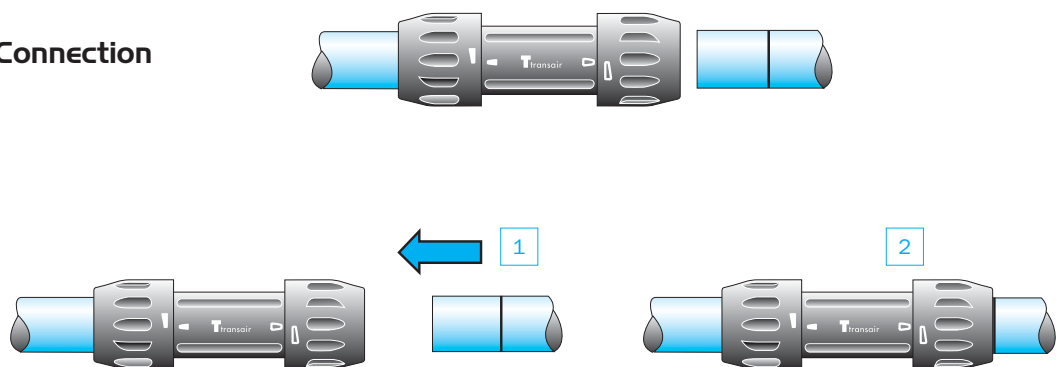

Disconnection

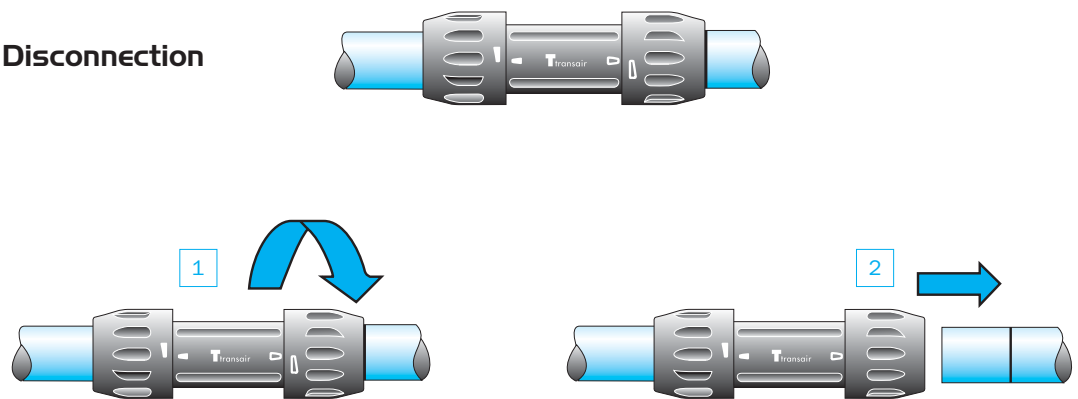

> Ø 16,5
Ø 25
Ø 40

Simply insert the pipe into the connector up to the connection mark.
To disconnect, unscrew the nut by one half turn and remove the pipe.

Lateral dismantling: see page 72 of this guide.

> **NB – when
using end caps
(ref. 6625)**

The insertion length is greater for end caps than for other Transair® connectors. The connection mark should be applied to the pipe by means of a marker and tape measure, using the following values:

- Ø 16.5: 39 mm
- Ø 25: 42 mm
- Ø 40: 64 mm

> Ø 63

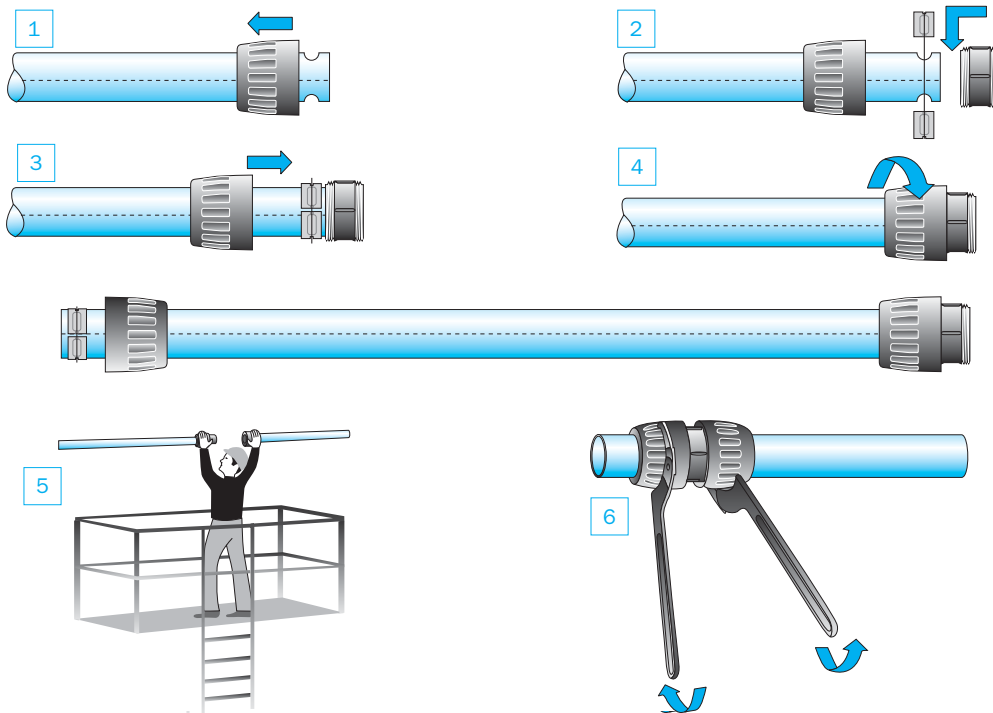
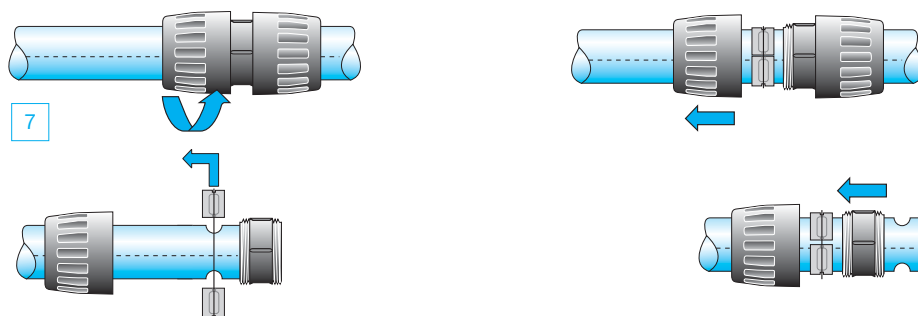
Connection**Disconnection**

- 1 - Unscrew one of the connector nuts and fit over the pipe.
- 2 - Position the double clamp ring in the appropriate housings (2 holes at the end of the pipe).
- 3 - Bring the nut towards the body, that has been previously positioned at the end of the pipe, until it stops against the double clamp.

- 4 - Tighten the nut by hand.
- 5 - Bring the two pipes together.
- 6 - Complete the assembly by 1/2 rotation with Transair® tightening spanners ref. 6698 05 03.
- 7 - To disconnect, perform the same operations in reverse order.

Lateral dismantling: see page 72 of this guide.

> Connection / disconnection

> Ø 76
Ø 100

Connection

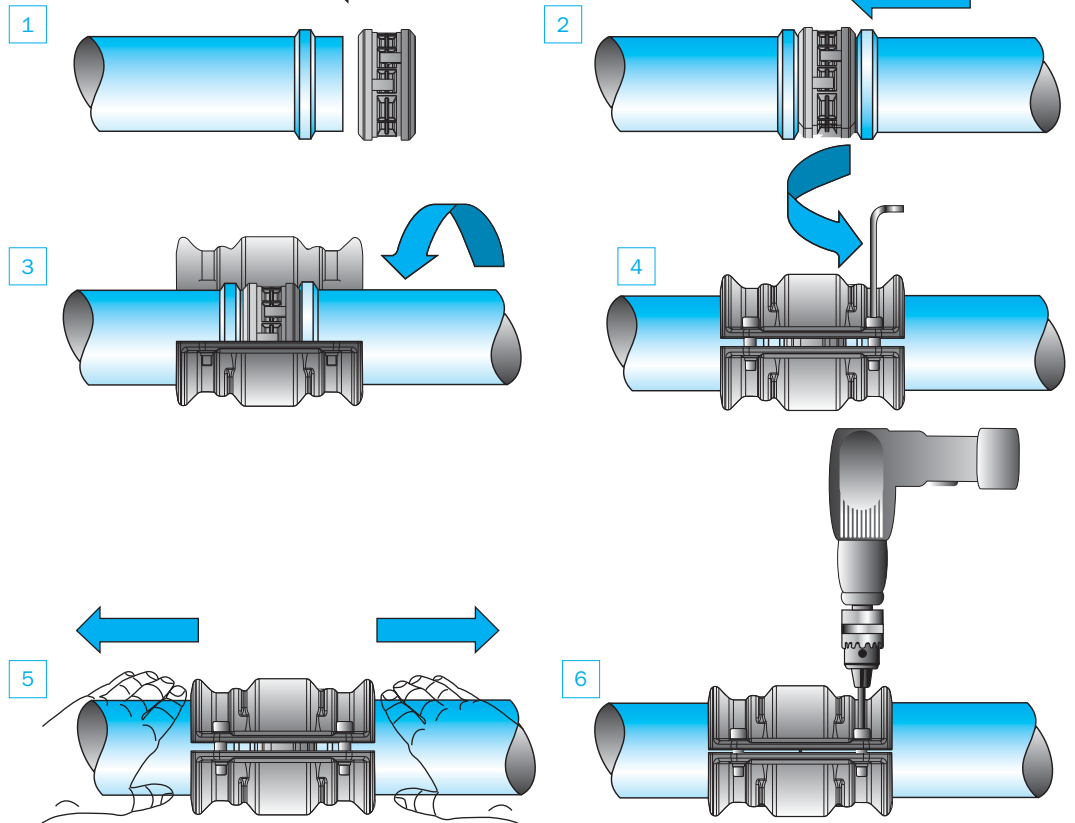

- 1 - Slip the cartridge over the end of the first pipe fully up to the shoulder.
- 2 - Bring the second pipe to the cartridge and slide fully up to the shoulder.
- 3 - Position the clamp over the cartridge / pipe assembly.

- 4 - Hand tighten the pre-fitted screws with an Allen key.
- 5 - Pull the pipes fully back towards the outside of the clamp.
- 6 - Fully tighten the clamp screws.
tightening torque mini:10Nm
Maximum tightening torque : final closure of clamps

For effective clamp sealing, screw tightening should be performed on alternate sides of the clamp as shown below :

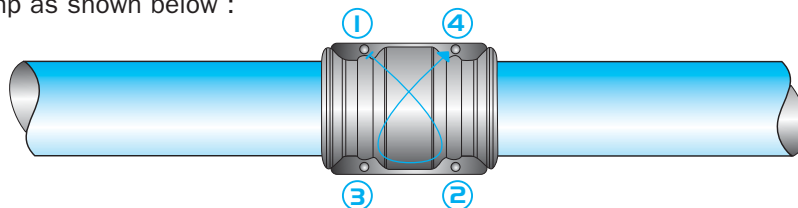

To disconnect, perform the same operations in reverse order.

> Practical examples

> Various Ø 76 and Ø 100 configurations							
> Changing direction with a 90° elbow		=	 1 x RX02	+ 2 x RR01			
> Changing direction with a tee piece		=	 1 x RX04	+ 3 x RR01			
> Connecting an end cap		=	 1 x RX25	+ 1 x RR01			
> Connecting a circular flange and a connector		=	 1 x EW05 1 x EW06	+ 1 x RX30	+ 1 x RR01		
> Reduction from Ø 100 to Ø 76		=	 1 x RR01 L3 00	+ 1 x RX66 L3 L1	+ 1 x RR01 L1 00		
> Connecting a butterfly valve		=	 1 x RR01	+ 1 x RX30	+ 1 x VR02	+ 1 x RX30	+ 1 x RR01
> Connecting a flexible hose and a circular flange		=	 1 x EW05	+ 1 x RX30 1 x EW06	+ 1 x RR01	+ 1 x FP01	

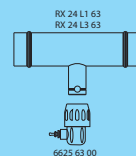
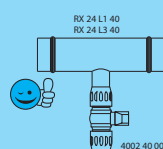
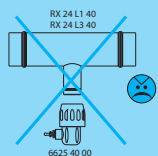

> Practical examples

> Connecting a Transair® \varnothing 76 or \varnothing 100 network to a Transair® \varnothing 63 \varnothing 40 \varnothing 25 \varnothing 16.5 network

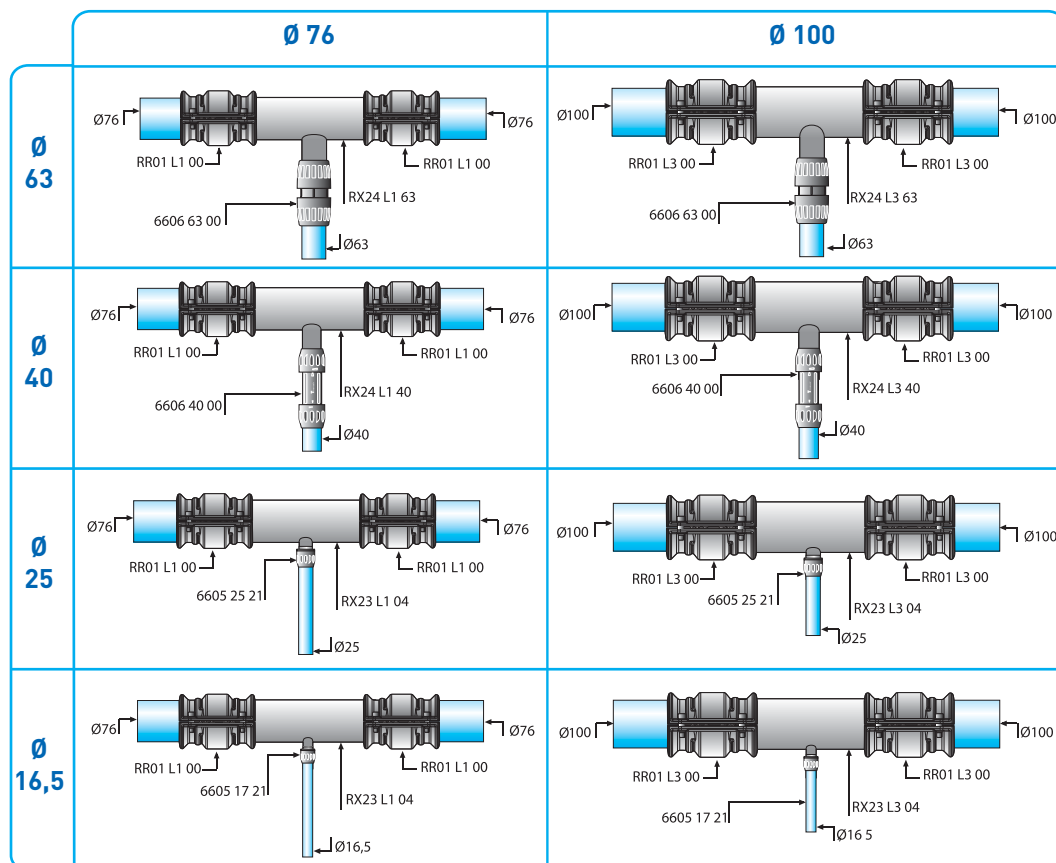

Minimum pipe centre-to-centre mounting distances for \varnothing 76 and \varnothing 100 tees

\varnothing D1(mm)	\varnothing D2(mm)	A(mm)	Bmini(mm)
100	100	90	470
100	76	80	410
100	63	90	327
100	40	46	225
100	25	46	215
100	16,5	46	200
76	76	80	420
76	63	90	314
76	40	46	212
76	25	46	202
76	16,5	46	187

Minimum pipe centre-to-centre mounting distances for \varnothing 76 and \varnothing 100 brackets

\varnothing D1(mm)	\varnothing D2(mm)	A(mm)	Bmini(mm)
100	25	46	250
76	25	46	240

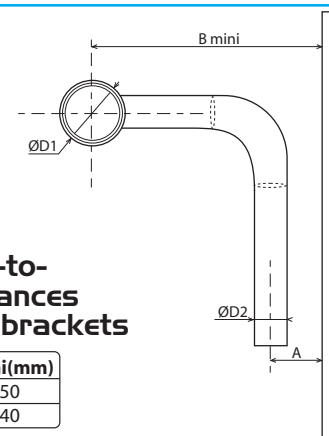

> System modification

> Replacing a pipe-to-pipe connector with a tee

For diameters Ø 16.5 - Ø 25 - Ø 40 only

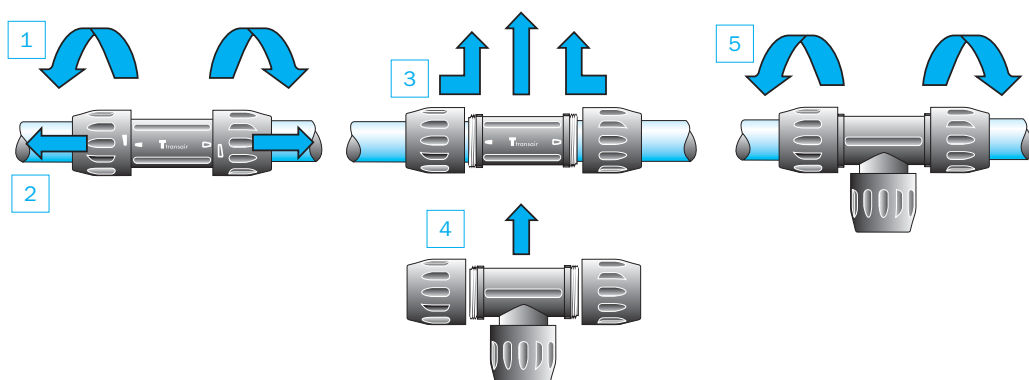

- 1 - Loosen the 2 nuts.
- 2 - Slide them along the pipe on either side of the connector.
- 3 - Remove the body of the connector, together with the nuts.

- 4 - Slide the nuts of the tee and position the body of the tee between the 2 pipes such that the solid and empty arrows are facing each other.
- 5 - Re-tighten the nuts until the empty and solid arrows are aligned with each other.

> Replacing a pipe-to-pipe connector with a ball valve

For diameters Ø 16.5 - Ø 25 - Ø 40 only

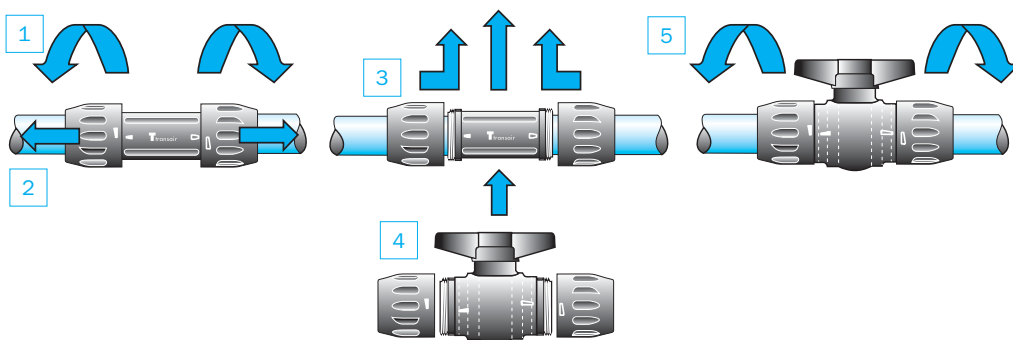

- 1 - Loosen the 2 nuts.
- 2 - Slide them along the pipe on either side of the connector.
- 3 - Remove the body of the connector, together with the nuts. Slide on the ball valve nuts.

- 4 - Position the body of the tee between the 2 pipes so that the empty and solid arrows are facing each other.
- 5 - Re-tighten the nuts until the empty and solid arrows are aligned with each other.

> Practical examples

> Lateral dismantling

> Ø 16,5
 Ø 25
 Ø 40

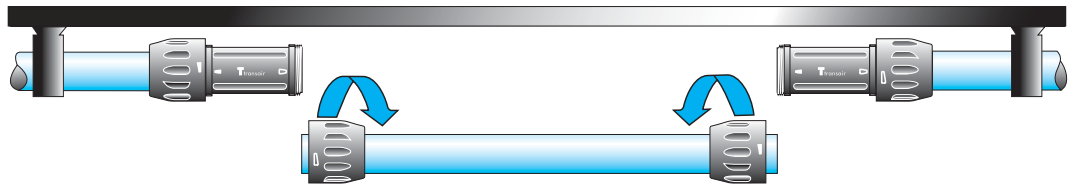

Loosen the nuts located on the side of the pipe to be removed and slide them along the pipe. Then remove the pipe

> Ø 63

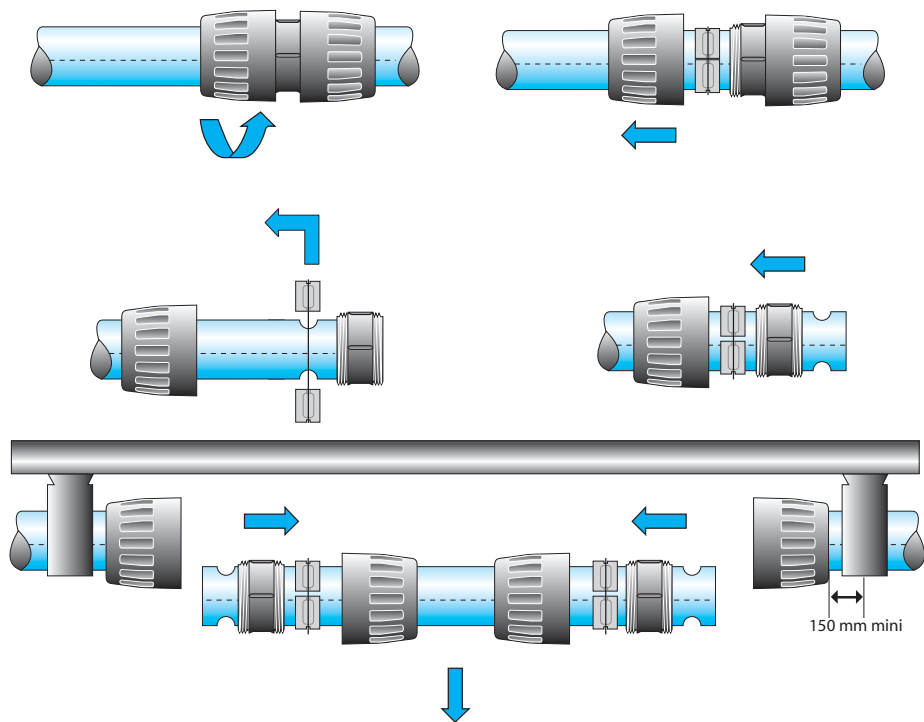

- 1 - Loosen the connector nuts on the ends of the pipe to be removed
- 2 - Slide them along the pipe.
- 3 - Remove the clamp rings from their housings.

- 4 - Slide the clamps and the connector body along the pipe which is to be removed.
- 5 - Repeat the operation at the other end of the pipe and laterally remove the pipe, complete with the assembly components.

> Transair® Ø 40 remote shut-off valve

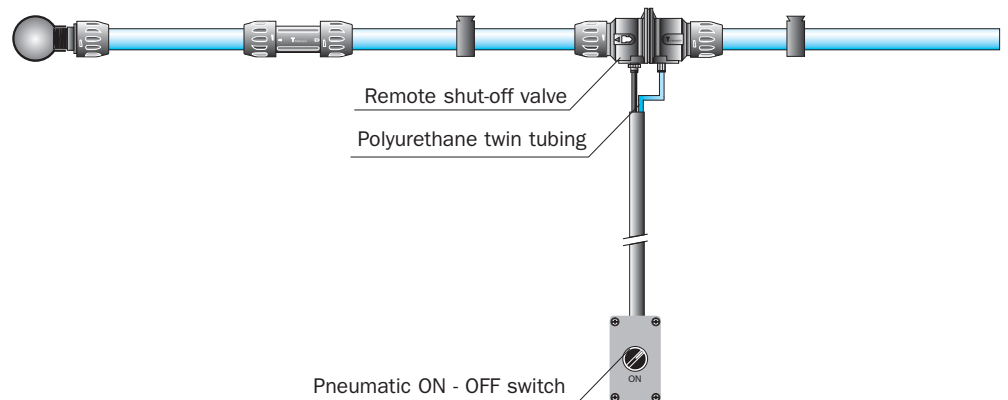

> Application

Assembled by simple and fast connection to aluminium pipe, the Transair® Ø 40 remote shut-off valve allows network supply to be rapidly and safely opened and closed either at ground level or by remote control.

The Transair® remote shut-off valve thus guarantees :

- Personal safety, by eliminating all hazards related to working at heights.
- Servicing speed, by removing the need for special access equipment (ladder, platform etc)

> Operating principle

Single acting valve - normally closed.

For compressed air networks :

the valve control pressure can be taken upstream of the isolating valve, with no external power supply. Control is performed through the control unit connected to the valve by means of a push-in connector.

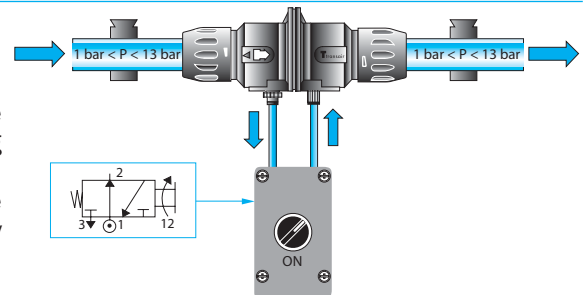

For vacuum networks :

a compressed air supply external to the control unit is required, and the corresponding valve port must be closed in order to prevent loss.

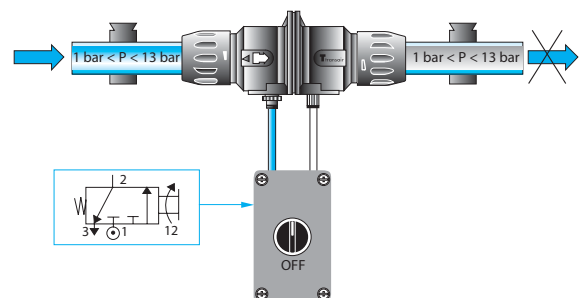

> Transair® connectors

> Do's

> Connection

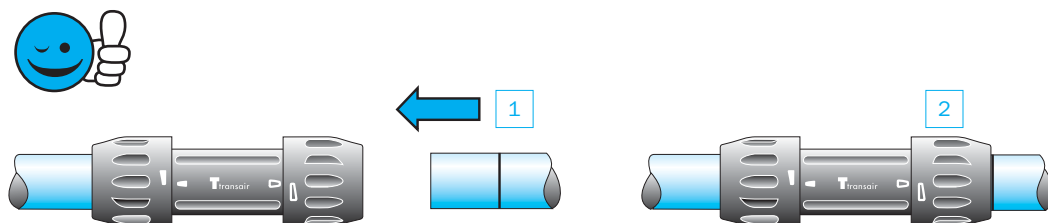

> Use a pipe cutter

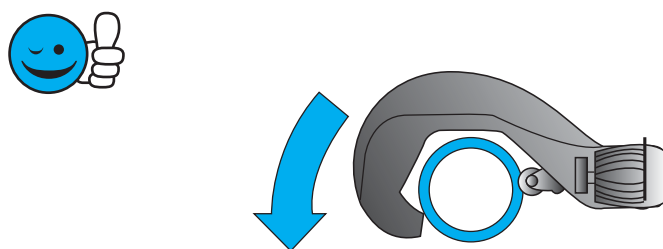

> Carefully chamfer and deburr the pipe after cutting or drilling

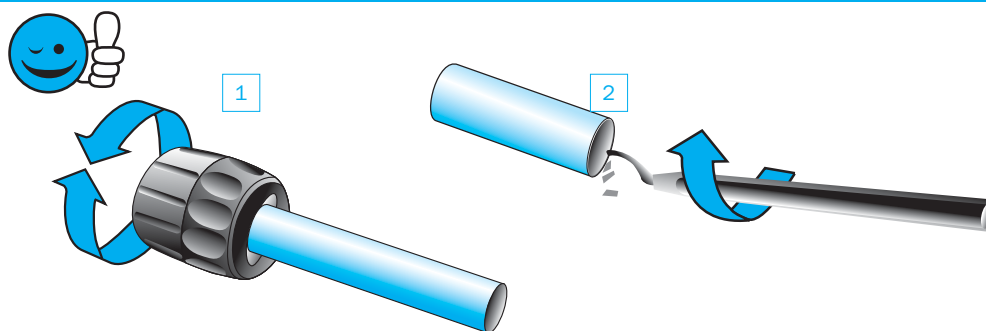

> Check that the pipe is correctly positioned in the connector

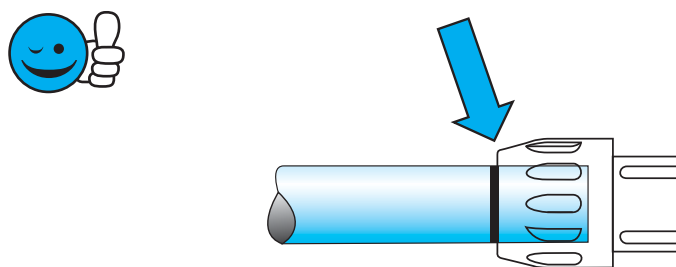

> Don'ts

> Loosen the nuts during assembly

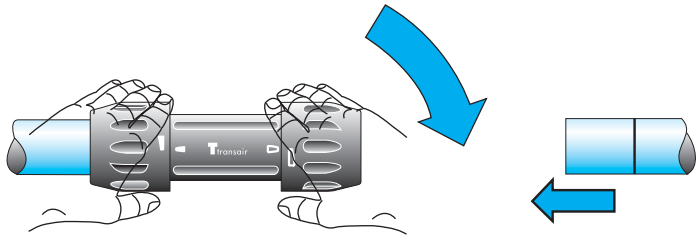

> Cut the pipe with a saw

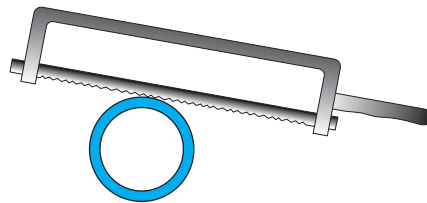

> Use non-deburred pipe

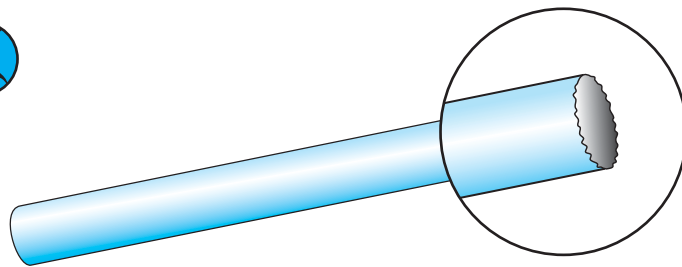

> Fail to make the pipe secure

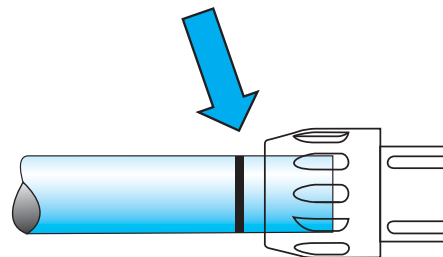

> Transair® quick assembly brackets

> General

The easy addition of a new drop or bypass onto an existing length of pipe is an important consideration for any air pipework system.

Transair® quick assembly brackets are designed for this very purpose, without the need to cut the pipe.

A «swans neck» built into the brackets retains condensate water in the main line. Thanks to its small size, the Transair® quick assembly bracket facilitates new additions in the tightest places and can be

used for connecting horizontal branch lines and vertical drops.

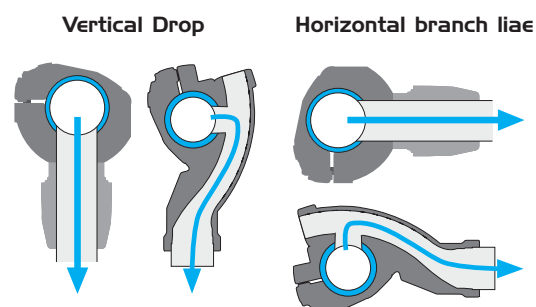

> Specific instructions for fitting a bracket

Ø 25 - Ø 40

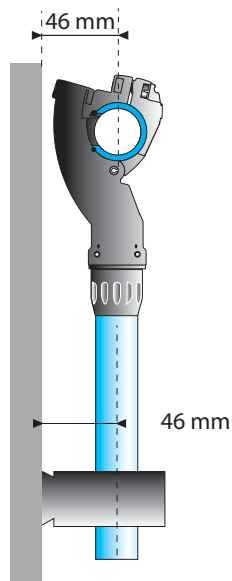

For Ø 25 and Ø 40 Transair® quick assembly brackets, the pipe centre to wall distance is equal to the bracket centre to wall distance, i.e. 46mm.

Ø 63

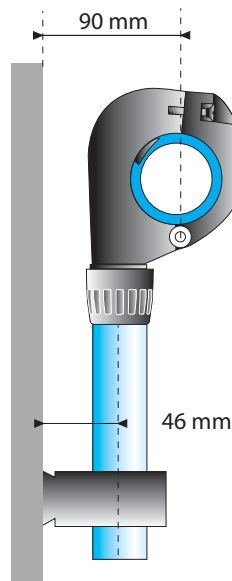

For Ø 63 Transair® quick assembly brackets the pipe centre to wall distance is 90mm and the Ø 25 and Ø 40 bracket centre distance is 46mm.

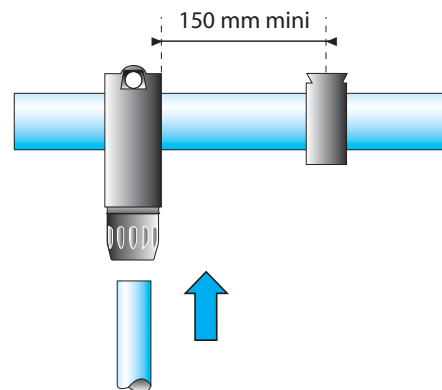

Furthermore, Transair® clips should be fitted at a distance of at least 150mm from a quick assembly bracket in order to allow for the expansion / contraction of aluminium pipe

> Fitting a quick assembly bracket

> To
Ø 25 Ø 40
pipe

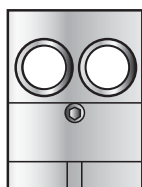

> Tools required

Drilling tool for
aluminium pipe
ref. 6698 02 02
6698 02 01

Drilling jig for
aluminium pipe
ref. 6698 01 01

Deburring tool for
aluminium pipe
ref. 6698 04 02

Permanent
marker pen

Allen key
/ Flat end
screwdriver

> Procedure

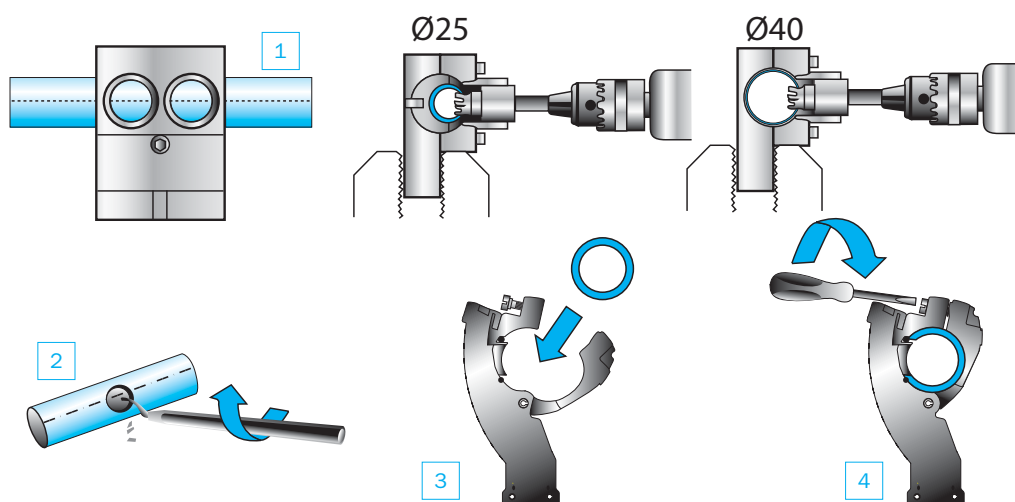

1 - Mark the pipe at the desired position for the bracket, using the same locator mark when several take-off points need to be aligned uniformly. Place the drilling jig ref. 6698 01 01 in a vice or on the floor. To drill a Ø 40 hole, remove the retaining bolt in the jig using an allen key and place the pipe in the jig. The locator mark on the pipe should be aligned with the appropriate guide marks on the side of the jig. Two guide lines on either side of the jig provide a rapid indication of whether the pipe is correctly positioned (the guide lines match the locator marks on the pipe). Close the jig and drill a hole using the appropriate drilling tool :

- Ø 25 : Ø 16 hole > ref. 6698 02 02 drilling tool
- Ø 40 : Ø 22 hole > ref. 6698 02 01 drilling tool

Recommended rotation speed: 650 rpm

NB : drill without lubrication.

2 - Release the pipe, deburr and remove any swarf and the cut circular piece of pipe. Repeat the operation for the number of brackets that you wish to fit.

3 - Position the quick assembly bracket using its location pin

4 - Tighten the nut.

Remark : the jig's second drilling guide corresponds to the minimum distance for fitting two adjacent brackets or a "double hole" quick assembly bracket ref 6662 25 00 / 6662 40 00

> Transair® quick assembly brackets

> Fitting a bracket

> On Ø 63 pipe

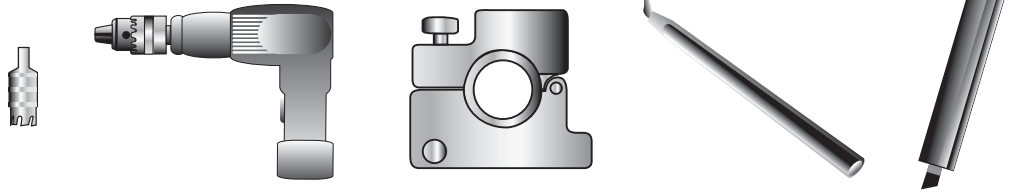

> Tools required

Drilling tool for aluminium pipe
ref. 6698 02 01

Drill

Drilling jig for aluminium pipe
ref. 6698 01 02

Deburring tool for aluminium pipe
ref. 6698 04 02

Permanent marker pen

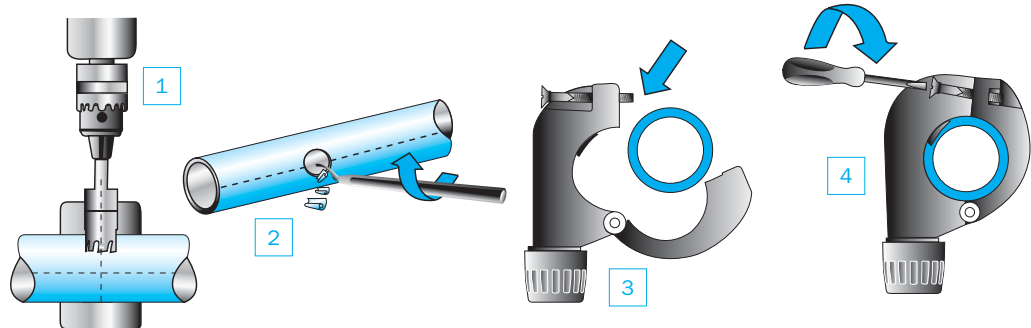

> Procedure

- 1 - Mark the pipe at the desired position for the bracket. The mark should be placed on one of the locator marks so that multiple brackets are correctly aligned, when several take-off points are required. Place the Ø 63 drilling jig in a vice or on the floor and place the pipe in the jig. Ensure that the line marked on the pipe is centred within the drilling guide: 2 marks on either side of the jig's upper side provide a rapid indication of the pipe's positioning. Tighten the locking clamp to secure the pipe and drill using the Ø 22 drilling tool. [Recommended rotation speed: 650 rpm] NB: drill without lubrication.
- 2 - Loosen the locking clamp and release the pipe, deburr and remove any swarf and the cut circular aluminum piece of pipe. Repeat the operation for the number of brackets that you wish to fit.
- 3 - Position the quick assembly bracket using its location hole.
- 4 - Tighten the nut.

> On \varnothing 76
 \varnothing 100 pipe

> Tools required



Drilling tool for
aluminium pipe,
ref. EW09 00 30



Deburring tool for
aluminium pipe
ref. 6698 04 02

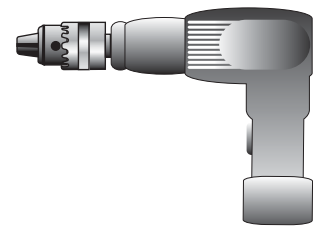

Drill

> Procedure

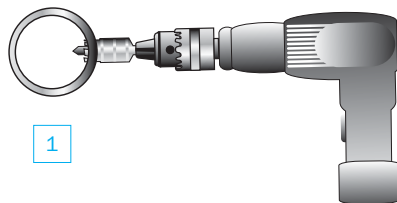

1 - Drill the aluminum pipe at the desired position
using drilling tool ref. EW09 00 30

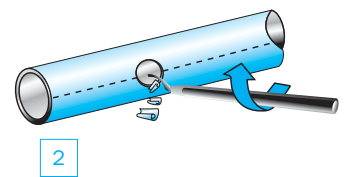

2 - Carefully deburr the pipe

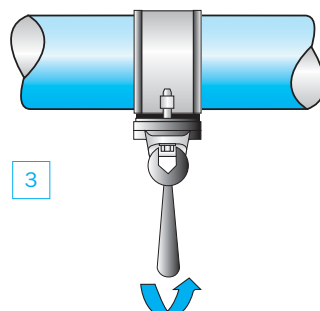

3 - Position bracket ref. RR61 and fully tighten the
2 screws

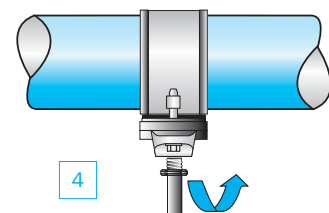

4 - Screw on male adapter ref. 6621 25 34

NB: adapter ref. 6621 25 34, in combination with bracket ref. RR61, is used to create a \varnothing 25 take-off point from \varnothing 76 or \varnothing 100 pipe

> Transair® quick assembly brackets

> Practical examples

> Creating vertical and horizontal take-off points

Using the same locator mark

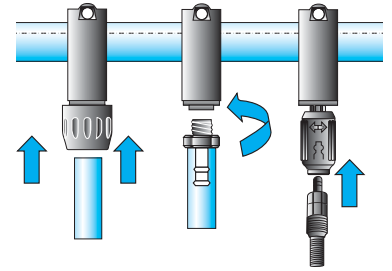
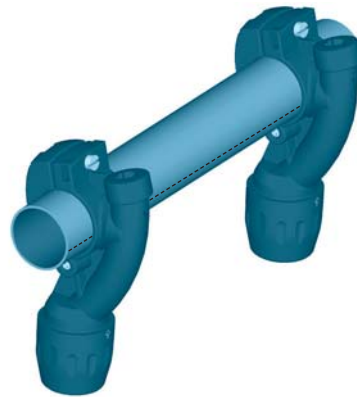

> Adding a vertical bracket

Using 2 locator marks

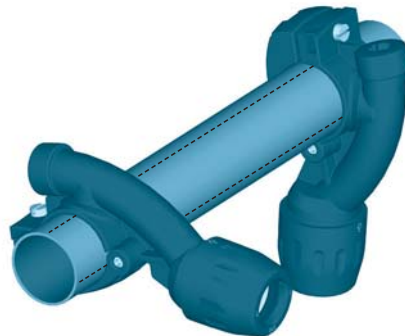

> Adding an off-set bracket

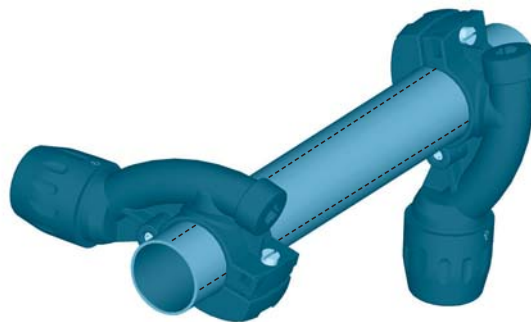

> Fitting a bracket to a pressurised system

> Tools required

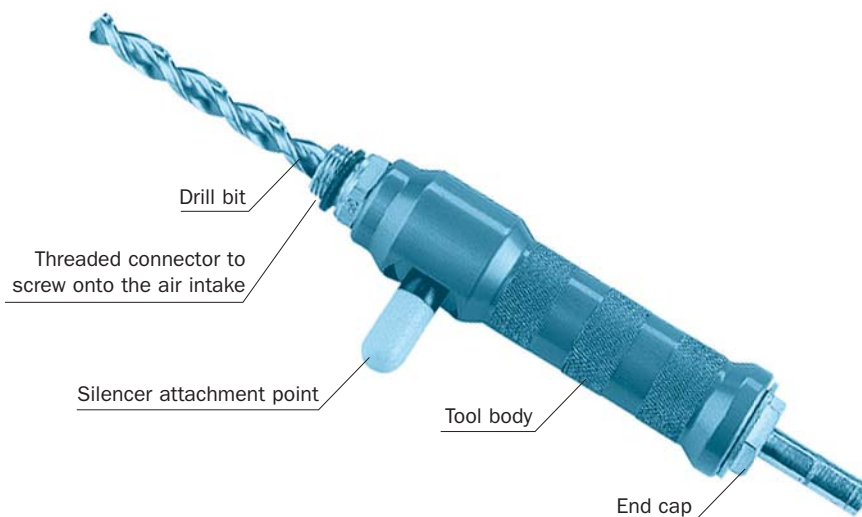

Use the under pressure drilling tool to fit a bracket to an existing pressurised system. This can be simply done with use of a standard drill

> Procedure

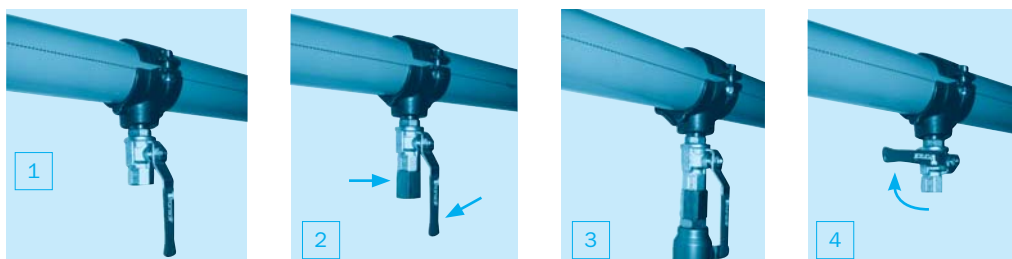

- 1 - Position the pressurised system bracket and fully tighten the 2 screws.
- 2 - Screw the assembly onto the ball valve. Ensure that the valve is open.

- 3 - Screw the drilling tool onto the ball valve. Drill fully.
- 4 - Remove the drill and close the ball valve immediately. Dismantle the drilling tool.

> Transair® flexible hose

> General

Transair® flexible hose can be easily connected to other Transair® components and can be rapidly installed without prior preparation or cutting.

Thanks to its small bend radius, it requires minimum space and avoids mechanical stress within the network.

Robust, Transair® flexible hose is resistant to both compressor oils and to fire

> Applications

Ø (mm)	Length (mm)	Transair®	Rmini (mm)
25	570	1001E25 00 01	100
25	1500	1001E25 00 03	100
25	2000	1001E25 00 04	100
25	570	1001E25V00 01	75
25	1500	1001E25V00 03	75
25	2000	1001E25V00 04	75
40	1150	1001E40 00 02	400
40	2000	1001E40 00 04	400
40	3000	1001E40 00 05	400
40	950	1001E40V00 07	160
40	2000	1001E40V00 04	160
40	3000	1001E40V00 05	160
63	1400	1001E63 00 08	300
63	3000	1001E63 00 05	650
63	4000	1001E63 00 06	650
63	3000	1001E63V00 05	250
63	4000	1001E63V00 06	250
76	1500	FP01 L1 01	350
76	2000	FP01 L1 02	350
100	2000	FP01 L3 01	450
100	3000	FP01 L3 03	450

> Level change

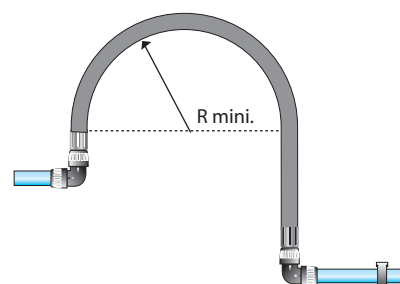

> Obstacle bypass



> Expansion loop

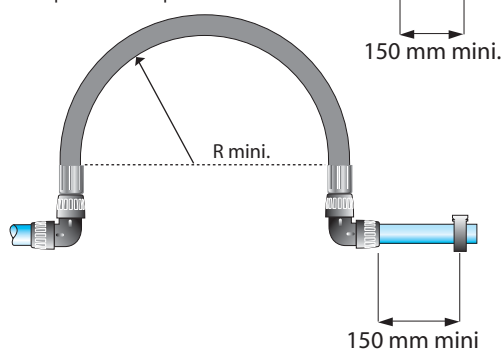

> Safety

> Anti-whiplash straps



In order to avoid the risk of whiplash accidents Transair® recommends the use of anti-whiplash straps, placed on either side of the connection.

If Transair® flexible tube is exposed to tear, the anti-whiplash assembly prevents it from snaking (safety device in accordance with ISO 4414 standard).

> Network connection

> Ø 16,5
Ø 25
Ø 40

> Using a male stud fitting

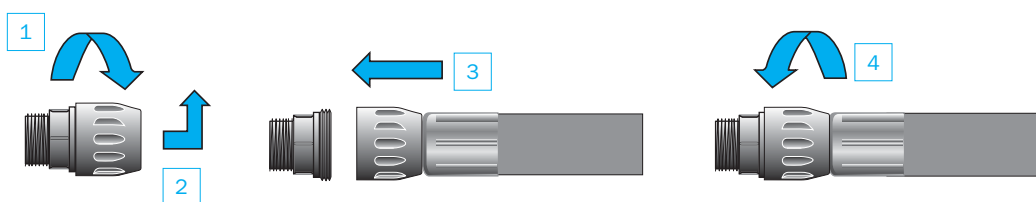

- 1 - Loosen the nut on the stud fitting
- 2 - Remove it
- 3 - Move the swaged end of the hose

- 4 - Tighten the nut.

> Using a pipe to pipe connector

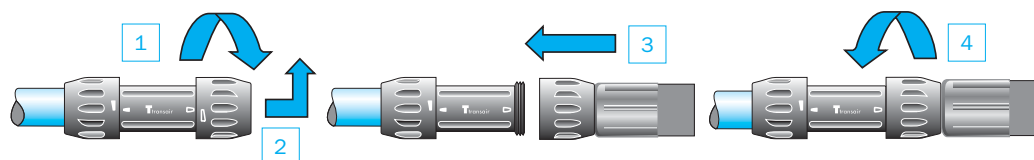

- 1 - Loosen the nut on the connector
- 2 - Remove it
- 3 - Move the swaged end of the hose

- 4 - Tighten the nut.

> Using a 90° elbow

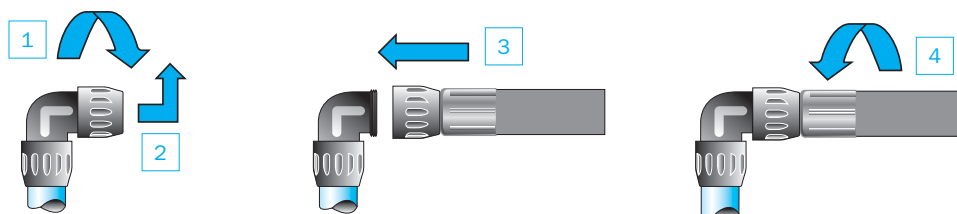

- 1 - Loosen the nut on the elbow
- 2 - Remove it

- 3 - Move the swaged end of the hose onto towards the elbow thread
- 4 - Tighten the nut.

> Transair® flexible hose

> Network connection

> Ø 63

> Using a male stud fitting

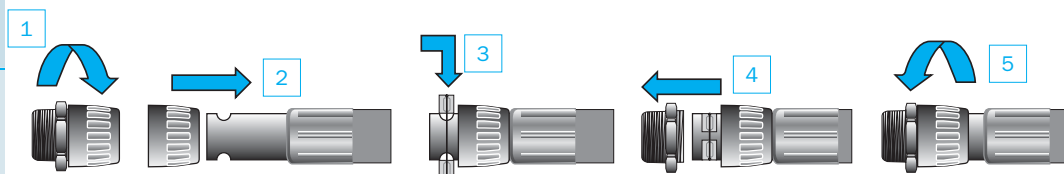

- 1 - Loosen the nut on the stud fitting and remove it
- 2 - Place the nut over the swaged end of the flexible hose
- 3 - Place the pipe connector clamps in the housings on the hose.

- 4 - Slide the nut forward to the end of the flexible hose, and assemble onto the male thread.
- 5 - Tighten the nut using the Ø 63 spanner set

> Using a pipe to pipe connector

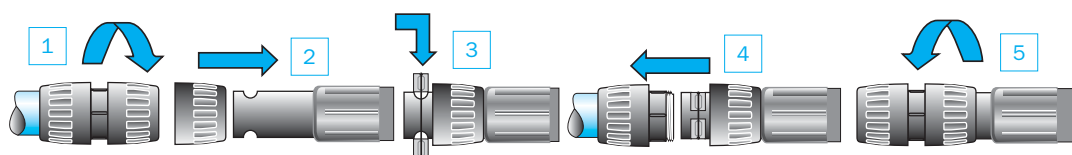

- 1 - Loosen the nut on the connector and remove it
- 2 - Fit it over the swaged end of the flexible hose
- 3 - Place the pipe connector clamps in the housings on the hose.

- 4 - Slide the nut forward to the end of the flexible hose, until it touches the clamps.
- 5 - Tighten the nut using the Ø 63 spanner set

> Using a 90° elbow

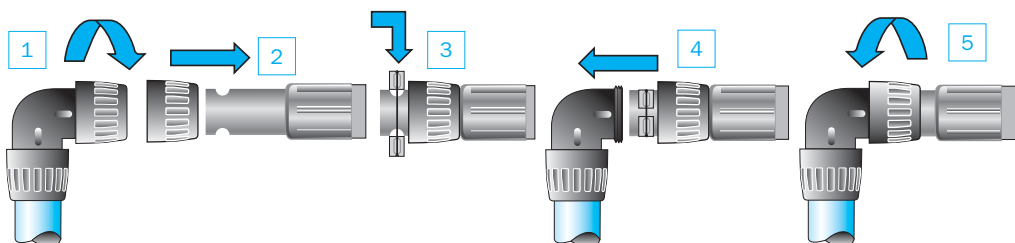

- 1 - Loosen the nut on the elbow and remove it
- 2 - Fit it over the swaged end of the flexible hose
- 3 - Place the elbow clamps in the housings on the hose

- 4 - Slide the nut forward to the end of the flexible hose, until it touches the clamps
- 5 - Tighten the nut using the Ø 63 spanner set

> Ø 76 - 100

> Using a steel clamp

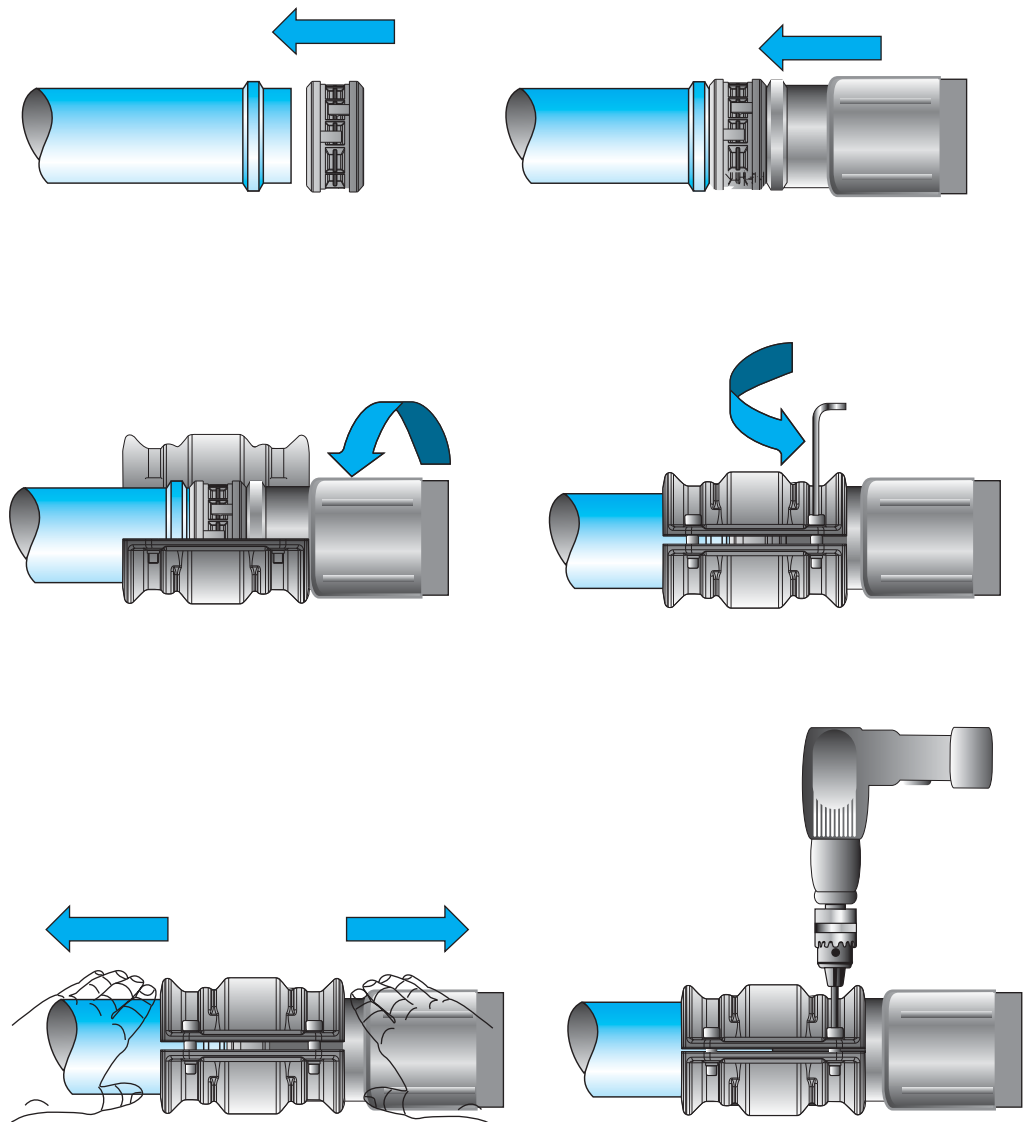

> Transair® flexible hose

> Do's / Don'ts

> Do's

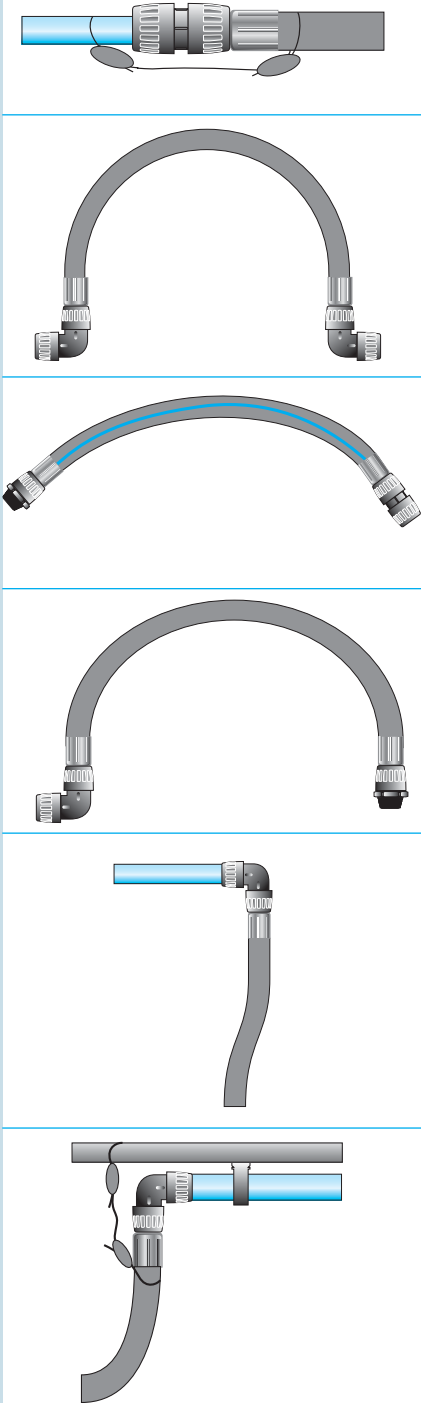

> Don'ts

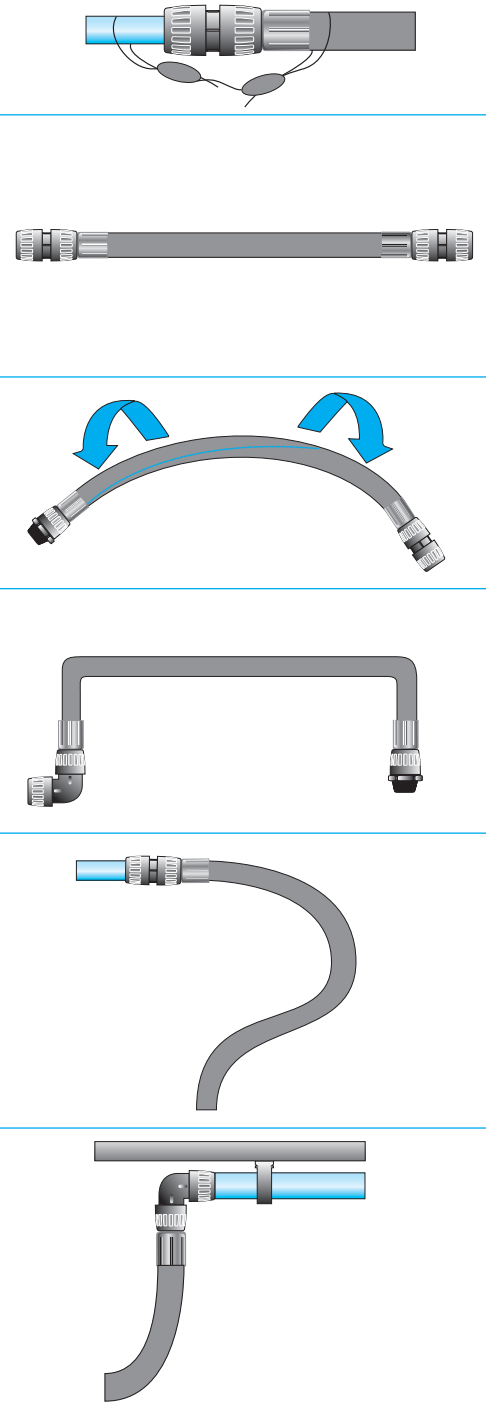

> Installation

> Columns

Floor, wall attachment

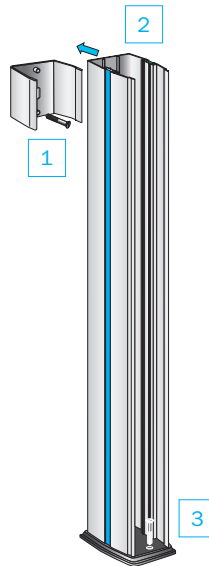

- 1 - Fix the bracket to the wall
- 2 - Clip on the column
- 3 - Screw the base to the floor

Floor, ceiling attachment

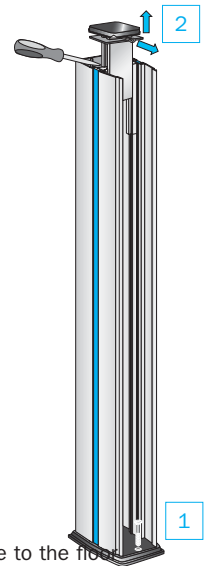

- 1 - Fix the base to the floor
- 2 - Release the cylinder to lock the column in position

> Modules

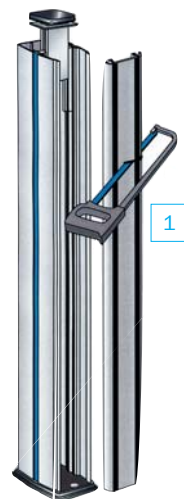

- 1 - Measure and saw to the required height and module spacing

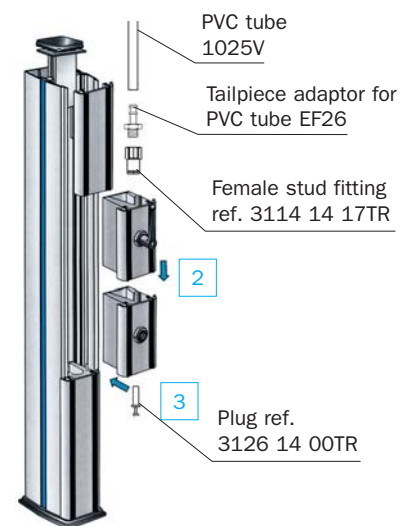

- 2 - Connect the modules together
- 3 - Clip into place on the column

> Attachment and support

> Transair® attachments

> Transair® clip for Ø 16,5, Ø 25, Ø 40 and Ø 63 rigid pipe

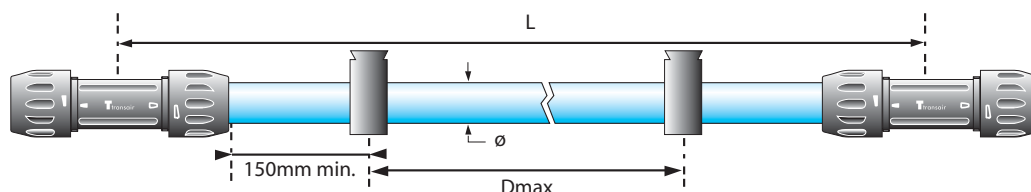

The Transair® fixing clip is the basic component for mounting pipe when installing.

Ø 16,5 – Ø 25 – Ø 40 – Ø 63 Transair® aluminium networks. Only this clip should be used since it allows expansion and contraction of the pipe to occur freely.

To ensure good system stability, we recommend the use of at least 2 clips per pipe.

Transair® aluminium pipe should only be mounted using these clips. They should not be substituted by any other type of clip or fixing.

Ø	L (m)	Dmax (m)
16,5	3	2,5
25	3	2,5
25	6	3
40	3	2,5
40	6	4
63	3	2,5
63	6	4

> Properties

- Transair® fixing clips for Ø 16,5 - Ø 25 - Ø 40: M6 nuts
- Transair® fixing clips for Ø 63 networks: M10 nuts

> Procedure

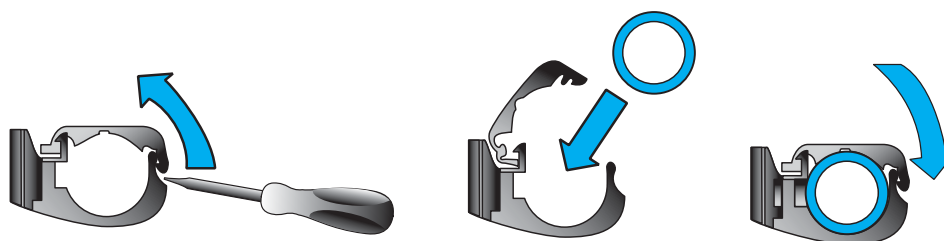

- 1 - Place the clip as required and open it using a screwdriver.
- 2 - Insert the pipe into the clip.
- 3 - Close the clip.

> Spacer

The Transair® 6697 00 03 spacer is used for fitting a run of Transair® pipe using different diameters.



Example :

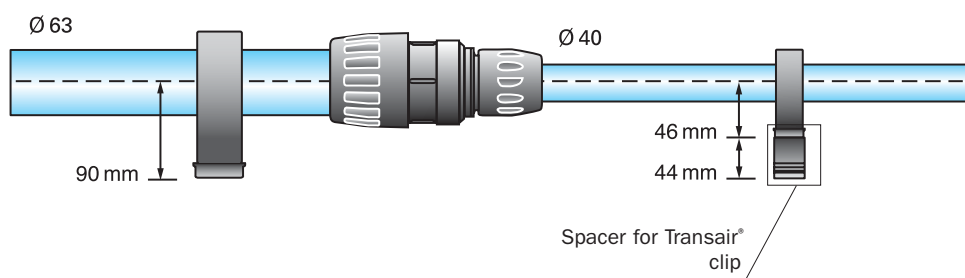

> Transair® fixing clip for Ø 76 - Ø 100 networks

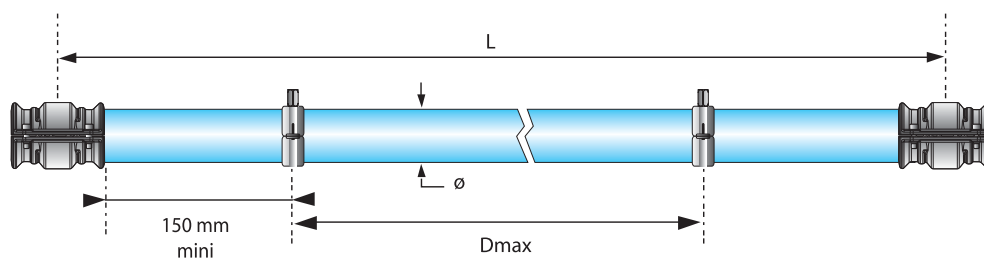

Ø	L (m)	Dmax (m)
76	3	2,5
76	6	5
100	3	2,5
100	6	5

To ensure good network stability, we recommend the use of at least 2 fixing clips per length of pipe

Transair® fixing clips for Ø 76 and Ø 100 networks: M8/M10 thread

> Attachment and support

> Supporting a Transair® system

> Directly onto a wall

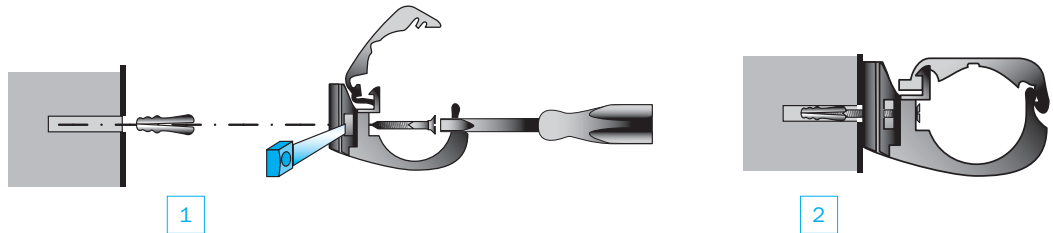

> Offset from a wall

- 1 - Remove the nut at the base of the pipe clip using a screwdriver. Insert the screw by passing it through the clip.
- 2 - Tighten the screw.

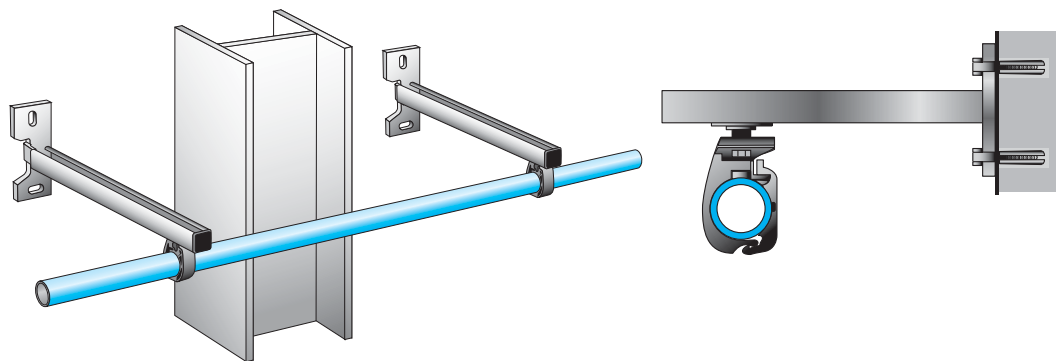

> U- channel type mounting bracket

U-channel assemblies are used to offset networks and to bypass obstacles. They comprise sectional rail ref. 6699 01 01 and a series of attachment accessories 66 99 01 02.

For offsetting a $\varnothing 63$ / $\varnothing 76$ and $\varnothing 100$ air system, we recommend the use of the rail clip attachment assembly ref. 6699 01 03.

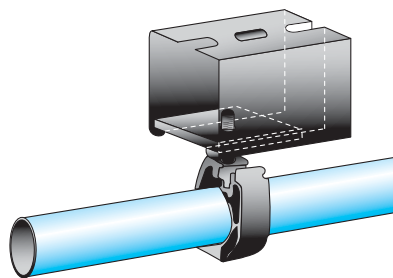

$\varnothing 63$

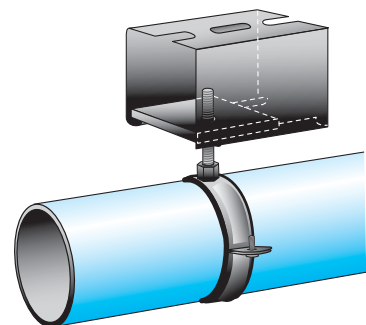

$\varnothing 76 - \varnothing 100$

> Beneath a cabletray

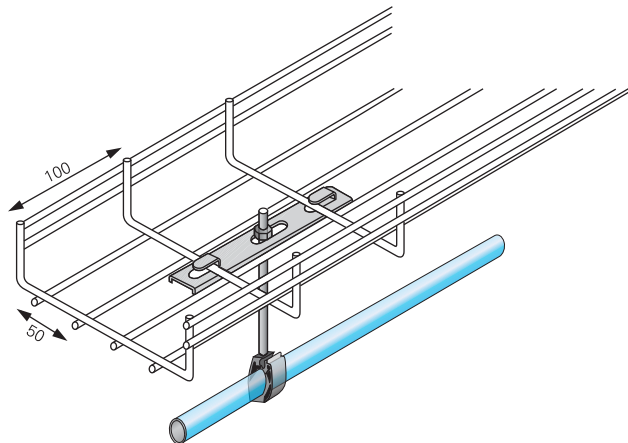

Use the under-cabletray attachment ref. 6699 10 03 and suspend with threaded rod up to M10 diameter

This attachment can be used to suspend networks from $\varnothing 16.5$ to $\varnothing 100$.

> Threaded rod adapter

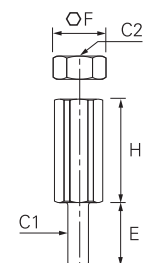
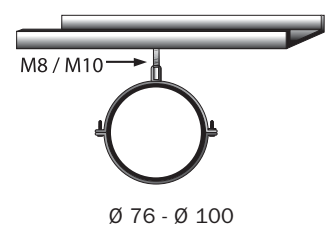
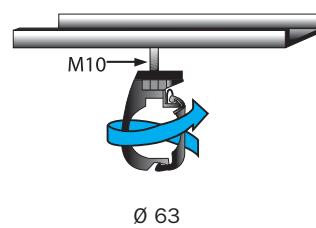
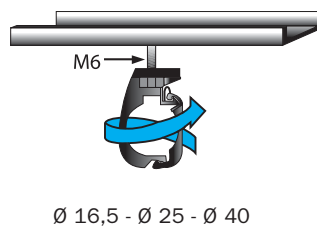

C1 : M6
C2 : M8 ou M10

Handy!

The Transair® threaded rod adaptor allows $\varnothing 16,5$, $\varnothing 25$ and $\varnothing 40$ Transair® pipe clips to be easily suspended under M8 or M10 threaded rod. C2: M8 or M10.

> Attachment and support

> Supporting a Transair® network

> On a metal beam

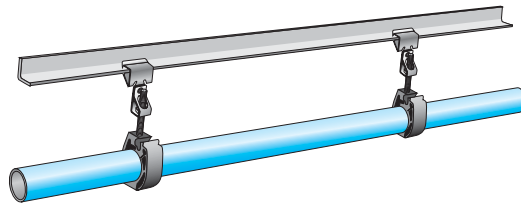

Push-on type beam clamps

Position the clamps ref. 6699 02 onto the RSJ or beam in accordance with the minimum recommended number of attachments per length of pipe and the required distance between attachments, according to the diameter of the pipe

> Using beam clamps

Position the clamps ref. 6699 03 onto the RSJ or beam in accordance with the minimum recommended number of attachments per length of pipe and the required distance between attachments, according to the diameter of the pipe

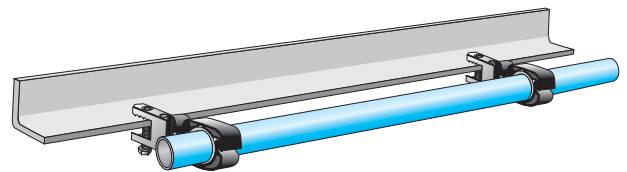

Screw type beam clamps

> U-channel brackets

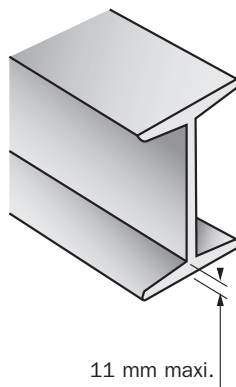

11 mm maxi.

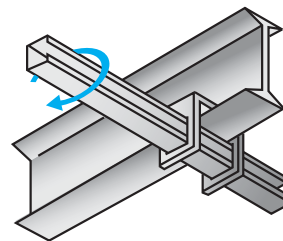

Horizontal assembly

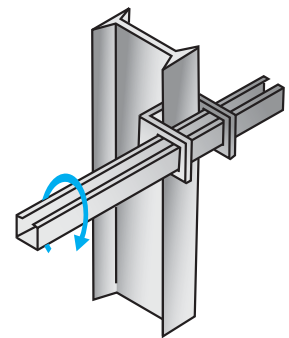

Vertical assembly

Position the RSJ brackets ref. 6999 03 02 on either side of the girder profile, then slide through the U-channel sectional rail.

> Under Canalis®

> KN (40 to 100A)

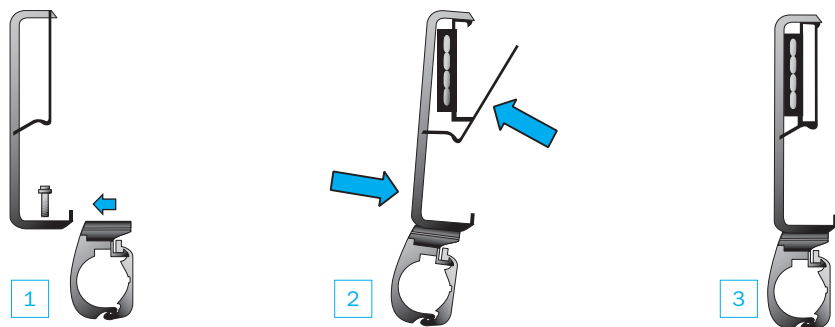

- 1 - Mount the Transair® pipe clip onto the KN attachment.
- 2 - Suspend the attachment from the Canalis® network and clip into place
- 3 - The support is ready.

> KS (100 to 800A)

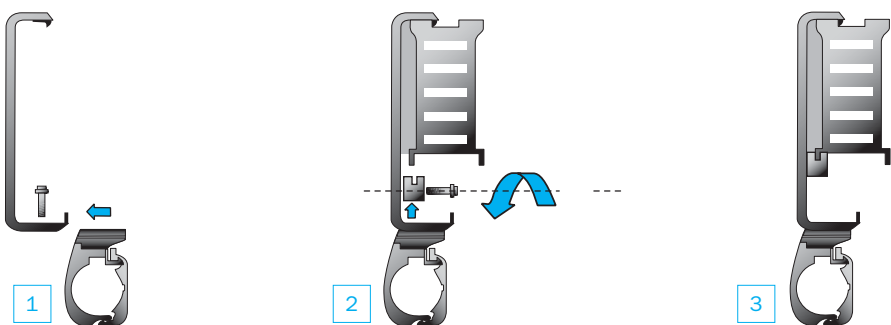

- 1 - Mount the Transair® pipe clip onto the KS attachment.
- 2 - Suspend the attachment from the Canalis® network and secure with a screw.
- 3 - The support is ready.

> Practical information

> Z dimensions

Transair®	Z (mm)	Z1 (mm)	Z2 (mm)
4002 40 00	-	57	57
4002 63 00	-	84	98
4012 63 00	-	84	98
4089 17 00	-	29	42
4089 25 00	-	40	55
4099 17 00	-	29	42
4099 25 00	-	40	55
4230 00 40	85	-	-
6612 25 00	29	-	-
6612 40 00	45	-	-
6602 17 00	31	-	-
6602 25 00	40	-	-
6602 40 00	62	-	-
6602 63 00	61	-	-
6604 17 00	-	34	31
6604 25 00	-	48	40
6604 40 00	-	57	57
6604 63 00	-	61	61
6604 63 40	-	61	116
6606 17 00	33	-	-
6606 25 00	48	-	-
6606 40 00	57	-	-
6606 63 00	25	-	-
6651 25 12 04	107	-	-
6651 40 12 04	150	-	-
6662 25 00	52	-	-
6662 25 17	59	-	-
6662 40 17	75	-	-
6662 40 25	68	-	-
6662 63 25	75	-	-
6666 17 25	50	-	-
6666 25 40	71	-	-
6676 17 00	33	-	-
6676 25 00	48	-	-
6676 40 00	57	-	-
6676 63 00	25	-	-
RA69 25 17	47,5	-	-
RA69 40 25	61	-	-
RX02 L1 00	189	-	-
RX02 L3 00	221	-	-
RX04 L1 00	-	145	145
RX04 L3 00	-	155	135
RX04 L3 L1	-	155	135
RX23 L1 04	145	-	-
RX23 L3 04	155	-	-
RX24 L1 40	-	145	228
RX24 L1 63	-	145	285
RX24 L3 40	-	155	241
RX24 L3 63	-	155	298
RX64 L1 63	352	-	-
RX64 L3 63	372	-	-
VR02 L1 00	116	-	-
VR02 L3 00	123	-	-

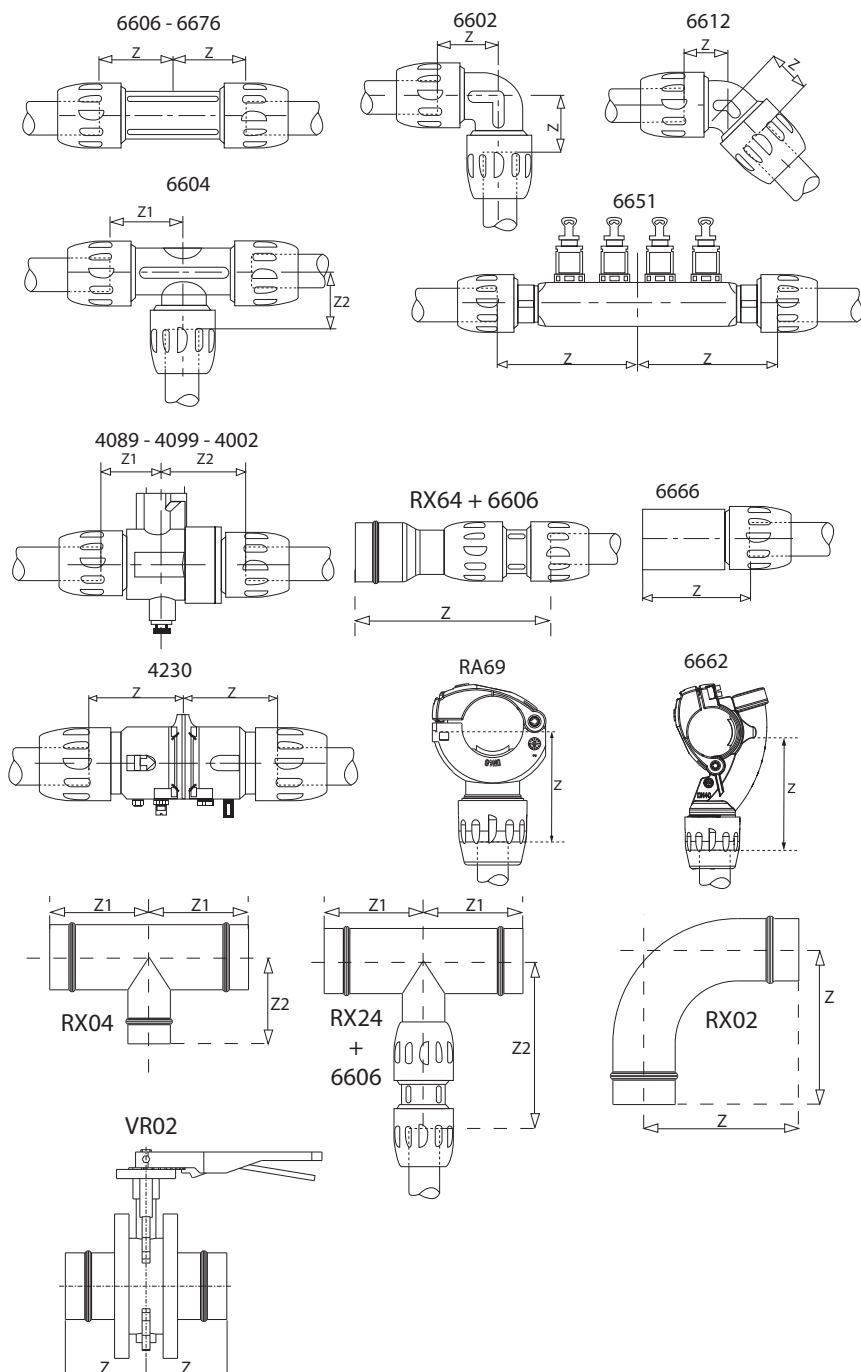

> Expansion / contraction

In order to compensate for the effects of expansion and contraction due to variations in temperature, any fluctuations in the length of the Transair® aluminium pipe network should be calculated.

L : length of Transair® straight line to be installed (in m)

ΔT : difference between temperature when installing and maximum operating temperature (in °C)

ΔL : line length variation (in mm)

For Transair® \emptyset 16.5 - \emptyset 25 - \emptyset 40 - \emptyset 63 - \emptyset 76 - \emptyset 100 aluminium pipe networks :

$$\Delta L = \underbrace{(a \times L)}_1 + \underbrace{(0.024 \times L \times \Delta T)}_2$$

1 - Expansion related to pipe retraction in the connector

2 - Expansion related to temperature variations

	\emptyset 16.5	\emptyset 25	\emptyset 40	\emptyset 63	\emptyset 76	\emptyset 100
3 m pipe	a=0,06	a=0,20	a=0,40	a=0,73	a=1,0	a=1,0
6 m pipe	-	a=0,10	a=0,20	a=0,38	a=0,50	a=0,50

The following tables give the length variations in mm according to network length, diameter and temperature variation, for Transair® aluminium pipe

$\Delta T = 15^\circ\text{C}$

3 m pipe							6 m pipe					
L (m)	\emptyset 16.5	\emptyset 25	\emptyset 40	\emptyset 63	\emptyset 76	\emptyset 100	L (m)	\emptyset 25	\emptyset 40	\emptyset 63	\emptyset 76	\emptyset 100
30	13	17	23	34	37	37	30	14	17	22	22	22
40	17	22	30	45	50	50	40	18	22	30	30	30
50	21	28	38	56	62	62	50	23	28	37	37	37
60	25	34	46	67	74	74	60	28	34	44	44	44
70	29	36	53	78	87	87	70	29	39	52	52	52
80	34	45	61	90	99	99	80	37	45	59	59	59

$\Delta T = 20^\circ\text{C}$

3 m pipe							6 m pipe					
L (m)	\emptyset 16.5	\emptyset 25	\emptyset 40	\emptyset 63	\emptyset 76	\emptyset 100	L (m)	\emptyset 25	\emptyset 40	\emptyset 63	\emptyset 76	\emptyset 100
30	16	20	26	37	40	40	30	17	20	26	25	25
40	22	27	35	50	53	53	40	23	27	34	33	33
50	27	34	44	62	66	66	50	29	34	43	41	41
60	32	41	53	74	79	79	60	35	41	52	49	49
70	38	43	62	87	92	92	70	36	48	60	57	57
80	43	54	70	99	106	106	80	46	54	69	66	66

> Practical information

> Expansion / contraction

$$\Delta T = 25^{\circ}\text{C}$$

3 m pipe

L (m)	Ø 16.5	Ø 25	Ø 40	Ø 63	Ø 76	Ø 100
30	20	24	30	41	42	42
40	26	32	40	54	56	56
50	33	40	50	68	70	70
60	40	48	60	82	84	84
70	46	50	70	95	98	98
80	53	64	80	109	112	112

6 m pipe

L (m)	Ø 25	Ø 40	Ø 63	Ø 76	Ø 100
30	21	24	29	27	27
40	28	32	39	36	36
50	35	40	49	45	45
60	42	48	59	54	54
70	43	56	69	63	63
80	56	64	78	72	72

$$\Delta T = 30^{\circ}\text{C}$$

3 m pipe

L (m)	Ø 16.5	Ø 25	Ø 40	Ø 63	Ø 76	Ø 100
30	23	28	34	44	44	44
40	31	37	45	59	59	59
50	39	46	56	74	74	74
60	47	55	67	89	89	89
70	55	57	78	104	104	104
80	62	74	90	118	118	118

6 m pipe

L (m)	Ø 25	Ø 40	Ø 63	Ø 76	Ø 100
30	25	28	33	29	29
40	33	37	44	39	39
50	41	46	55	49	49
60	49	55	66	59	59
70	50	64	77	69	69
80	66	74	88	78	78

> $\Delta T = 35^{\circ}\text{C}$

3 m pipe

L (m)	Ø 16,5	Ø 25	Ø 40	Ø 63	Ø 76	Ø 100
30	27	31	37	48	47	47
40	36	42	50	64	62	62
50	45	52	62	80	78	78
60	54	62	74	96	94	94
70	63	64	87	112	109	109
80	72	83	99	128	125	125

6 m pipe

L (m)	Ø 25	Ø 40	Ø 63	Ø 76	Ø 100
30	28	31	37	32	32
40	38	42	49	42	42
50	47	52	61	53	53
60	56	62	73	64	64
70	57	73	85	74	74
80	75	83	98	85	85

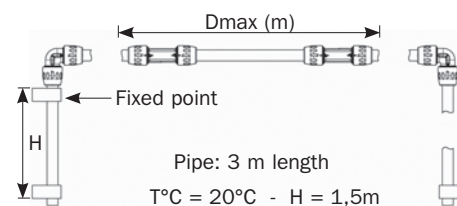
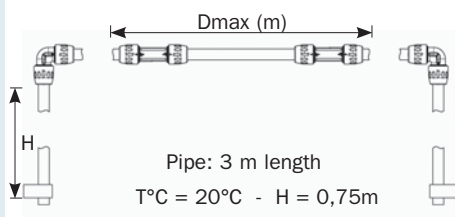

Case no. 1:
Maximum distance, without expansion loop, from a fixed point dependant on Transair® diameter (2 elbows)

Ø Transair®	16,5	25	40	63	76	100
Dmax. (m)	50	40	30	24	15	15

Case no. 2:
Maximum distance, without expansion loop, dependant on Transair® diameter (2 elbows - 1 fixed point)

Ø Transair®	16,5	25	40	63	76	100
Dmax. (m)	50	40	30	25	15	15

> **Example**

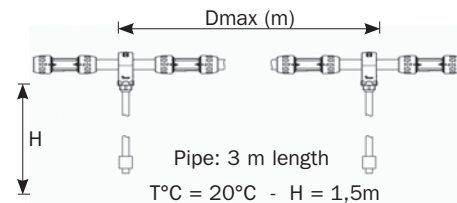
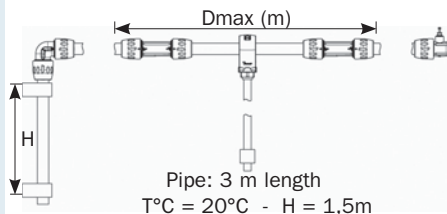

Case no. 3:
Maximum distance for fitting a bracket, without expansion loop, dependant on Transair® diameter (1 elbow - 1 bracket)

Ø Transair®	16,5	25	40	63	76	100
Dmax. (m)	48	38	30	25	7,5	7,5

Case no. 4:
Maximum distance for fitting a bracket, without expansion loop, dependant on Transair® diameter (2 brackets)

Ø Transair®	16,5	25	40	63	76	100
Dmax. (m)	80	70	55	40	15	15

> Practical information

> Expansion / contraction

In addition to expansion loops, changes of direction are another method of compensating for expansion and contraction.

> Direction change

> For Transair®
 Ø 16.5 - Ø 25 - Ø 40 - Ø 63
 aluminium pipe networks

H= 0,75 m	$\Delta L1= 15$ mm
H= 1,50 m	$\Delta L1= 30$ mm

> Using an elbow

> For Transair®
 Ø 76 -Ø 100
 aluminium pipe networks

H= 0,75 m	$\Delta L1= 10$ mm
H= 1,50 m	$\Delta L1= 20$ mm

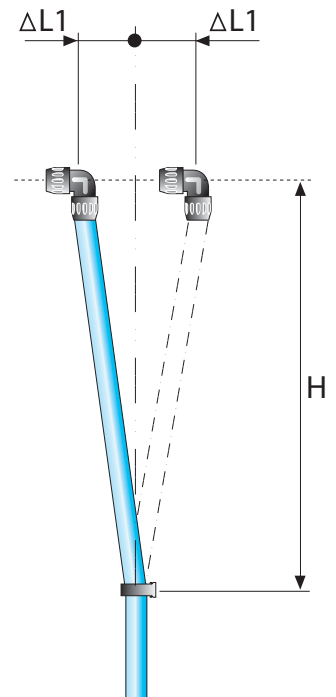

> Using a quick assembly bracket

> For Transair® Ø 16.5 - Ø 25 - Ø 40 - Ø 63
 aluminium pipe networks

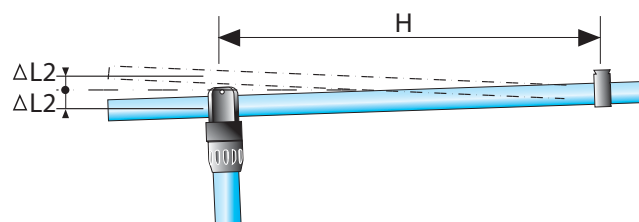

Ø1	Ø2	H (m)	$\Delta L2$ (mm)	$\Delta L3$ (mm)
25	16,5	1,5	13	26
25	25	1,5	13	26
40	16,5	1,5	13	26
40	25	1,5	13	26
63	25	1,5	13	26

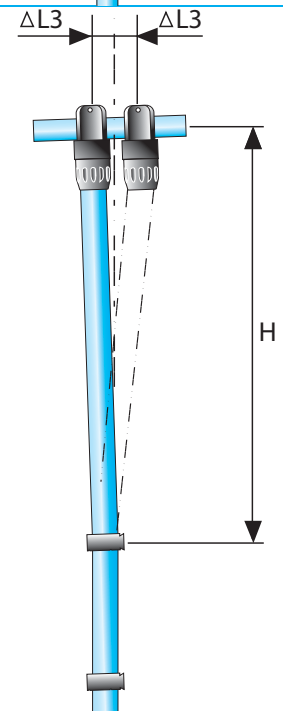

The length variation ΔL , calculated for the Transair® line, must always be equal to or less than $\Delta L2$ and $\Delta L3$. If this is not the case, then an expansion loop, using Transair® flexible hose, must be added.

> For Transair® Ø 76 -Ø 100 aluminium pipe networks

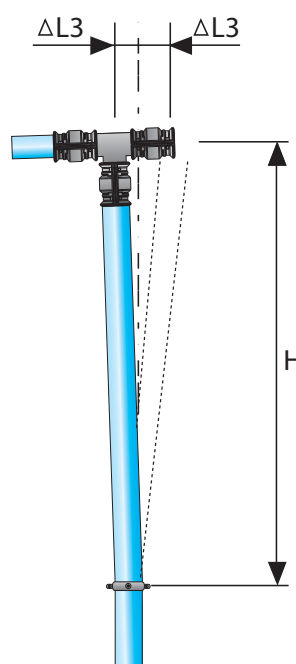
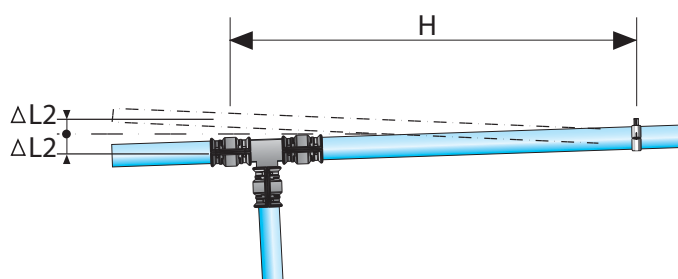

> Changing direction with a tee piece

Ø	H (m)	ΔL2 maxi (mm)	ΔL3 maxi (mm)
76	0,75	10	10
100	0,75	10	10

> Practical information

> Conversion charts

> Length

millimetre (mm)	metre (m)	inch (in)	foot (ft)	yard (yd)
10	0,01	0,39	0,03	0,01
20	0,02	0,79	0,07	0,02
30	0,03	1,18	0,10	0,03
40	0,04	1,57	0,13	0,04
50	0,05	1,97	0,16	0,05
60	0,06	2,36	0,20	0,07
70	0,07	2,76	0,23	0,08
80	0,08	3,15	0,26	0,09
90	0,09	3,54	0,30	0,10
100	0,10	3,94	0,33	0,11
150	0,15	5,91	0,49	0,16
200	0,20	7,87	0,66	0,22
250	0,25	9,84	0,82	0,27
300	0,30	11,81	0,98	0,33
350	0,35	13,78	1,15	0,38
400	0,40	15,75	1,31	0,44
450	0,45	17,72	1,48	0,49
500	0,50	19,69	1,64	0,55
550	0,55	21,65	1,80	0,60
600	0,60	23,62	1,97	0,65
700	0,70	27,56	2,30	0,76
800	0,80	31,50	2,62	0,87
900	0,90	35,43	2,95	0,98
1 000	1,00	39,37	3,28	1,09

> Pressure

Bar	Kilo Pascal (KPa)	Atmosphere (atm)	PSI	Torr (mm Hg)
1	100	0,99	14,50	750
2	200	1,97	29,00	1 500
3	300	2,96	43,50	2 250
4	400	3,95	58,00	3 000
5	500	4,93	72,50	3 750
6	600	5,92	87,00	4 500
7	700	6,91	101,50	5 250
8	800	7,90	116,00	6 000
9	900	8,88	130,50	6 750
10	1000	9,87	145,00	7 500
11	1100	10,86	159,50	8 250
12	1200	11,84	174,00	9 000
13	1300	12,83	188,50	9 750
14	1400	13,82	203,00	10 500
15	1500	14,80	217,50	11 250
16	1600	15,79	232,00	12 000
20	2000	19,74	290,00	15 000

> Flow rate

litres per second (l/s)	litres per minute (l/min)	cubic metres per minute (m ³ /min)	cubic metres per hour (m ³ /h)	cubic feet per minute (cfm)
10	600	0,60	36	21
20	1 200	1,20	72	42
30	1 800	1,80	108	64
40	2 400	2,40	144	85
50	3 000	3,00	180	106
60	3 600	3,60	216	127
70	4 200	4,20	252	148
80	4 800	4,80	288	169
90	5 400	5,40	324	191
100	6 000	6,00	360	212
150	9 000	9,00	540	318
200	12 000	12,00	720	424
250	15 000	15,00	900	530
300	18 000	18,00	1 080	635
350	21 000	21,00	1 260	741
400	24 000	24,00	1 440	847
450	27 000	27,00	1 620	953
500	30 000	30,00	1 800	1 059
550	33 000	33,00	1 980	1 165
600	36 000	36,00	2 160	1 271
700	42 000	42,00	2 520	1 483
800	48 000	48,00	2 880	1 694
900	54 000	54,00	3 240	1 906
1 000	60 000	60,00	3 600	2 118

> Air consumption values

Tools	Typical consumption at an operating pressure of 6 bar (Nm ³ /h)
Small process controls, instrumentation, pneumatic logic units	7
Paint spray gun, small impact wrench, light/medium drill, blowgun	From 9 to 30
Polisher, screwdriver	42
Sheet metal cutter, large impact wrench, automatic plane	48
Small automatic machines, miscellaneous tooling	54
Large tools, power machines and associated equipment	61
Air hoist, grinder	126

> Transair® networks in use

Quality control
department
(Metallurgy)

Transair® Ø 25
Direct drops and offset drops



Maintenance workshop
(Automotive)

Transair® Ø 25
Main network fixed under RSJ
Offset drops from a quick
assembly bracket



Production workshop
(Plastics processing)

Transair® Ø 40
Supply of machinery from
a swerved drop



Main compressed air
pipework system
(Aeronautics)

Transair® Ø 100 and Ø 40



Outside compressor room
(Furniture industry)

Transair® Ø 76

90° change of direction



Compressor room
(Electronics)

Transair® Ø 40 and Ø 16,5



> Transair® networks in use

Assembly workshop (Mechanics)

Transair® Ø 63 and Ø 25
Offset main network from
U-channel and threaded rod



Manufacturing cell (Automotive)

Transair® Ø 76 and Ø 40
Reduction from Ø 76 to Ø 40
Double outlet



Laboratory (Chemistry)

Transair® Ø 40
Instant connection



Laboratory
(Packaging)

Transair® Ø 63 and Ø 25
Offset drops from a quick
assembly bracket



Repair workshop
(Garage trade)

Transair® Ø 25 and Ø 16,5
Wall brackets, FRL and
Transair® hose reel



Machinery
(Watchmaking)

Transair® Ø 25



Parker Worldwide

Europe, Middle East, Africa

AE – United Arab Emirates, Dubai
Tel: +971 4 8127100
parker.me@parker.com

AT – Austria, Wiener Neustadt
Tel: +43 (0)2622 23501-0
parker.austria@parker.com

AT – Eastern Europe, Wiener Neustadt
Tel: +43 (0)2622 23501 900
parker.easteurope@parker.com

AZ – Azerbaijan, Baku
Tel: +994 50 2233 458
parker.azerbaijan@parker.com

BE/LU – Belgium, Nivelles
Tel: +32 (0)67 280 900
parker.belgium@parker.com

BY – Belarus, Minsk
Tel: +375 17 209 9399
parker.belarus@parker.com

CH – Switzerland, Etoy
Tel: +41 (0)21 821 87 00
parker.switzerland@parker.com

CZ – Czech Republic, Klecany
Tel: +420 284 083 111
parker.czechrepublic@parker.com

DE – Germany, Kaarst
Tel: +49 (0)2131 4016 0
parker.germany@parker.com

DK – Denmark, Ballerup
Tel: +45 43 56 04 00
parker.denmark@parker.com

ES – Spain, Madrid
Tel: +34 902 330 001
parker.spain@parker.com

FI – Finland, Vantaa
Tel: +358 (0)20 753 2500
parker.finland@parker.com

FR – France, Contamine s/Arve
Tel: +33 (0)4 50 25 80 25
parker.france@parker.com

GR – Greece, Athens
Tel: +30 210 933 6450
parker.greece@parker.com

HU – Hungary, Budapest
Tel: +36 1 220 4155
parker.hungary@parker.com

IE – Ireland, Dublin
Tel: +353 (0)1 466 6370
parker.ireland@parker.com

IT – Italy, Corsico (MI)
Tel: +39 02 45 19 21
parker.italy@parker.com

KZ – Kazakhstan, Almaty
Tel: +7 7272 505 800
parker.easteurope@parker.com

NL – The Netherlands, Oldenzaal
Tel: +31 (0)541 585 000
parker.nl@parker.com

NO – Norway, Asker
Tel: +47 66 75 34 00
parker.norway@parker.com

PL – Poland, Warsaw
Tel: +48 (0)22 573 24 00
parker.poland@parker.com

PT – Portugal, Leca da Palmeira
Tel: +351 22 999 7360
parker.portugal@parker.com

RO – Romania, Bucharest
Tel: +40 21 252 1382
parker.romania@parker.com

RU – Russia, Moscow
Tel: +7 495 645-2156
parker.russia@parker.com

SE – Sweden, Spånga
Tel: +46 (0)8 59 79 50 00
parker.sweden@parker.com

SK – Slovakia, Banská Bystrica
Tel: +421 484 162 252
parker.slovakia@parker.com

SL – Slovenia, Novo Mesto
Tel: +386 7 337 6650
parker.slovenia@parker.com

TR – Turkey, Istanbul
Tel: +90 216 4997081
parker.turkey@parker.com

UA – Ukraine, Kiev
Tel: +380 44 494 2731
parker.ukraine@parker.com

UK – United Kingdom, Warwick
Tel: +44 (0)1926 317 878
parker.uk@parker.com

ZA – South Africa, Kempton Park
Tel: +27 (0)11 961 0700
parker.southafrica@parker.com

North America

CA – Canada, Milton, Ontario
Tel: +1 905 693 3000

US – USA, Cleveland
Tel: +1 216 896 3000

Asia Pacific

AU – Australia, Castle Hill
Tel: +61 (0)2-9634 7777

CN – China, Shanghai
Tel: +86 21 2899 5000

HK – Hong Kong
Tel: +852 2428 8008

IN – India, Mumbai
Tel: +91 22 6513 7081-85

JP – Japan, Tokyo
Tel: +81 (0)3 6408 3901

KR – South Korea, Seoul
Tel: +82 2 559 0400

MY – Malaysia, Shah Alam
Tel: +60 3 7849 0800

NZ – New Zealand, Mt Wellington
Tel: +64 9 574 1744

SG – Singapore
Tel: +65 6887 6300

TH – Thailand, Bangkok
Tel: +662 717 8140

TW – Taiwan, Taipei
Tel: +886 2 2298 8987

South America

AR – Argentina, Buenos Aires
Tel: +54 3327 44 4129

BR – Brazil, Sao Jose dos Campos
Tel: +55 800 727 5374

CL – Chile, Santiago
Tel: +56 2 623 1216

MX – Mexico, Apodaca
Tel: +52 81 8156 6000

European Product Information Centre

Free phone: 00 800 27 27 5374

(from AT, BE, CH, CZ, DE, DK, EE, ES, FI, FR, IE, IL, IS, IT, LU, MT, NL, NO, PL, PT, RU, SE, SK, UK, ZA)



Fluid System Connectors Division Europe Transair Business Unit

CS 46911 - 74 rue de Paris
35069 Rennes

Phone : +33 (0)2 99 25 55 00

Fax : +33 (0)2 99 25 56 47

transair@parker.com

www.parkertransair.com