

CATALOGO SPESSORI
CALIBRATION SHIMS
SUPLEMENTOS DE CALIBRACION
КАЛИБРОВКИ ПРОКЛАДКИ
校準墊片



COMMON RAIL & DIESEL INJECTION SPARE PARTS

VERSIONE 13.0

SUITABLE

BOSCH
SIEMENS

DELPHI
NAVISTAR

DENSO
CATERPILLAR

& MORE



CONDIZIONI DI VENDITA

- I NOSTRI PREZZI SONO ESPRESSI IN EURO
- IL TRASPORTO SI INTENDE SEMPRE EXW (FRANCO FABBRICA)
 - L' IMBALLO È SEMPRE ADDEBITATO AL COSTO
 - I RECLAMI DOVRANNO ESSERE EFFETTUATI ALLA CONSEGNA
- I RECLAMI DEVONO ESSERE EFFETTUATI PER ISCRITTO E I RESI VANNO SOSTITUITI IN GARANZIA
- I PAGAMENTI VERRANNO CONCORDATI AL MOMENTO DELL' ORDINE.



SALES CONDITION

- ALL OUR PRICES ARE EXW CLAIMS MUST ADRESSED TO FORWARDER
 - PACKAGING COST NOT INCLUDED
 - FAULTY ITEMS ARE GARANTED WITH REPLACED GOODS
- OMS ITEMS ARE INTERCHANGEABLE WITH GENUINE ONE BUT MANUFACTURED BY OMS SO NOT GENUINE
 - OTHER MANUFACTURE' S NAME OR MEMBERS (GENUINE) ARE FOR COSTUMER REFERENCE ONLY.



условия продажи

- ТРАНСПОРТ ВСЕГДА БУДЕМ EXW
- УПАКОВКА 'Ы ВСЕГДА ВЗИМАЕТСЯ ПО
- СЕБЕСТОИМОСТИ ЖАЛОБЫ ДОЛЖНЫ БЫТЬ СДЕЛАНЫ, ЧТОБЫ ПЕРЕВОЗЧИКУ
 - ПРЕТЕНЗИИ ДОЛЖНЫ БЫТЬ В ПИСЬМЕННОЙ
- ФОРМЕ И СДЕЛАНЫ БЫТЬ ЗАМЕНЕН ПО ГАРАНТИИ ПЛАТЕЖИ БУДУТ СОГЛАСОВАНЫ ВО ВРЕМЯ "ПОРЯДКА



運輸應始終 EXW
的包裝總是按成本收費
投訴必須向承運人
索賠必須以書面形式提出, 並提出要在保修期內更換
款項將商定的"訂貨時

INDICE - TABLE OF CONTENTS

suitable
BOSCH

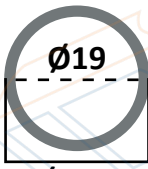

$\varnothing 19$
 $\varnothing 23,7$
PAG: 1A-2A

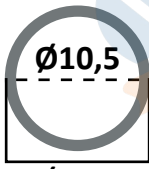

$\varnothing 10,5$
 $\varnothing 15,7$
PAG: 3A-4A

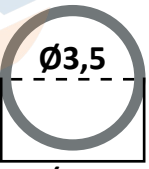

$\varnothing 3,5$
 $\varnothing 5,3$
PAG: 5A-6A
+ BOSCH PIEZO VERSION

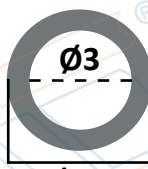

$\varnothing 3$
 $\varnothing 5,1$
PAG: 7A-8A

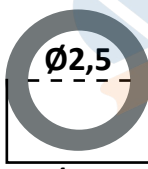

$\varnothing 2,5$
 $\varnothing 4,5$
PAG: 9A-10A



$\varnothing 2,5$
 $\varnothing 6,4$
PAG: 11A-12A



$\varnothing 2,3$
PAG: 13A-14A

VECCHIA VERSIONE
OLD VERSION



$\varnothing 5,8$
PAG: 15A-16A

NUOVA VERSIONE
NEW VERSION



$\varnothing 5,5$
PAG: 17A-18A



PAG: 19A-20A



$\varnothing 2,3$
 $\varnothing 4$
PAG: 21A-22A

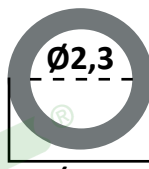

$\varnothing 2,3$
 $\varnothing 4,2$
PAG: 23A-24A



$\varnothing 4,4$
 $\varnothing 7,7$
PAG: 25A-26A

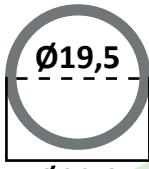

$\varnothing 19,5$
 $\varnothing 22,8$
PAG: 27A-28A

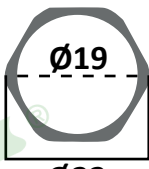

$\varnothing 19$
 $\varnothing 22$
PAG: 29A-30A



$\varnothing 18$
 $\varnothing 22$
PAG: 31A-32A

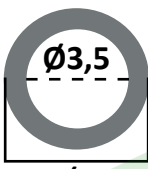

$\varnothing 3,5$
 $\varnothing 9$
PAG: 33A

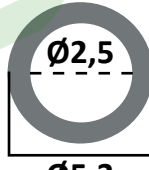

$\varnothing 2,5$
 $\varnothing 5,3$
PAG: 34A



$\varnothing 2,7$
 $\varnothing 5,4$
 $\varnothing 4,4$
 $\varnothing 9,8$
PAG: 35A



PAG: 36A

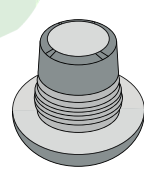

PAG: 37A-38A

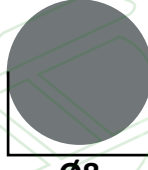

$\varnothing 8$
PAG: 39A



$\varnothing 6$
PAG: 40A

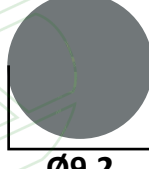

$\varnothing 9,2$
PAG: 41A

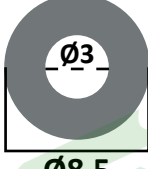

$\varnothing 3$
 $\varnothing 8,5$
PAG: 42A



$\varnothing 2,5$
 $\varnothing 7$
PAG: 43A-44A

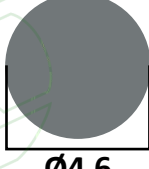

$\varnothing 4,6$
PAG: 45A

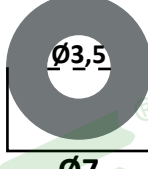

$\varnothing 3,5$
 $\varnothing 7$
PAG: 46A



$\varnothing 2,5$
 $\varnothing 7,35$
PAG: 47A-48A

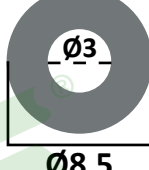

$\varnothing 3$
 $\varnothing 8,5$
PAG: 49A-50A

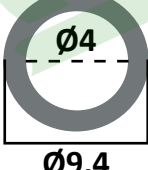

$\varnothing 4$
 $\varnothing 9,4$
PAG: 51A

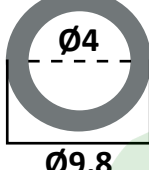

$\varnothing 4$
 $\varnothing 9,8$
PAG: 52A-53A

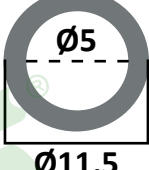

$\varnothing 5$
 $\varnothing 11,5$
PAG: 54A-55A

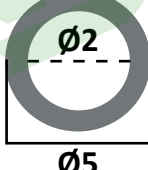

$\varnothing 2$
 $\varnothing 5$
PAG: 56A



PAG: 57A-58A-59A



PAG: 60A

suitable
SIEMENS

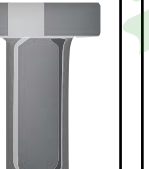

PAG: 1B

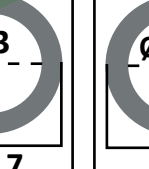

$\varnothing 3$
 $\varnothing 5,7$
PAG: 2B



$\varnothing 13,7$
 $\varnothing 20$
PAG: 3B

Spessore Esagonale "da Filo"
Exagonal Shim "for Wire"

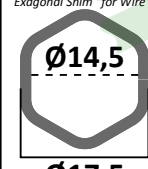

$\varnothing 14$
 $\varnothing 18$
 $\varnothing 14,5$
 $\varnothing 17,5$
PAG: 6B

INDICE - TABLE OF CONTENTS



suitable DELPHI	 Ø2,5 Ø5 PAG: 1C	 Ø3 Ø7,5 PAG: 2C	 Ø5,8 PAG: 3C	 Ø7 PAG: 4C	 Ø3,3 Ø7 PAG: 5C
 Ø4,7 Ø9,35 PAG: 6C	 Ø1,90 Ø4,35 PAG: 7C	 Ø4,80 Ø8,35 PAG: 8C	 Ø3,75 Ø7,50 PAG: 9C	 Ø3,75 Ø7,50 PAG: 10C	 Ø1,90 Ø4,4 PAG: 11C
 Ø4,6 Ø9,3 PAG: 12C	suitable DENSO	 Ø3,5 Ø6,75 PAG: 1D-2D	 Ø20 Ø23,2 PAG: 3D	 Ø3 Ø5,8 PAG: 4D	 Ø21,5 Ø24,3 PAG: 5D-6D
 Ø1,7 Ø3,95 PAG: 7D	 Ø1,6 Ø3,95 PAG: 8D	 Ø4,2 Ø6,4 PAG: 9D	 Ø22,5 Ø24,95 PAG: 10D	suitable VARI	 Ø2,6 Ø6,2 PAG: 1E
 Ø4,4 Ø8,9 PAG: 2E	 Ø2 Ø9,5 PAG: 3E	 Ø1 Ø6,3 PAG: 4E	 Ø3 Ø9,5 PAG: 5E	suitable NAVISTAR	 Ø16,5 Ø21,7 PAG: 1F
suitable CATERPILLAR	 Ø10 PAG: 1G	 Ø7,8 PAG: 2G	 Ø4,75 PAG: 3G	 Ø8,9 PAG: 2F	 Ø3,5 Ø7,35 PAG: 3F
 Ø22,5 Ø26 PAG: 4G	 Ø6,6 PAG: 5G	 Ø16,5 Ø21,8 PAG: 6G	 Ø1,1 Ø6 PAG: 7G	 Ø6 PAG: 8G	STRUMENTI DI MISURAZIONE MEASUREMENT TOOLS

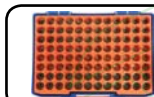

A SEGUIRE "VALIGETTE COMBinate"
COMBINED BAGS





VALIGETTA COMBINATA

COMBINED HANDBAG

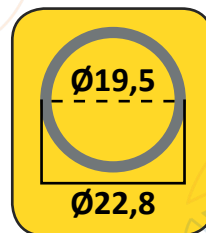
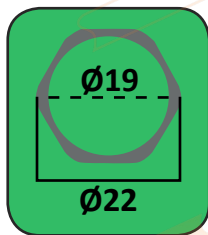
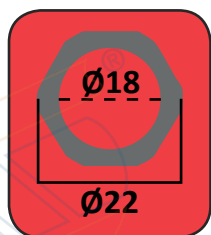

MISURA	RIF. ORIGINALE	COD.OMS
0,954	F 00R J00 026	11-23-288/0954
0,958	F 00R J00 028	11-23-288/0958
0,962	F 00R J00 030	11-23-288/0962
0,966	F 00R J00 032	11-23-288/0966
0,970	F 00R J00 034	11-23-288/0970
0,974	F 00R J00 036	11-23-288/0974
0,978	F 00R J00 038	11-23-288/0978
0,982	F 00R J00 040	11-23-288/0982
0,986	F 00R J00 042	11-23-288/0986
0,990	F 00R J00 044	11-23-288/0990
0,994	F 00R J00 046	11-23-288/0994
0,998	F 00R J00 048	11-23-288/0998
1,002	F 00R J00 050	11-23-288/1002
1,006	F 00R J00 052	11-23-288/1006
1,010	F 00R J00 054	11-23-288/1010
1,014	F 00R J00 056	11-23-288/1014
1,018	F 00R J00 058	11-23-288/1018
1,022	F 00R J00 060	11-23-288/1022
1,026	F 00R J00 062	11-23-288/1026
1,030	F 00R J00 064	11-23-288/1030
1,034	F 00R J00 066	11-23-288/1034
1,038	F 00R J00 068	11-23-288/1038
1,042	F 00R J00 070	11-23-288/1042
1,046	F 00R J00 072	11-23-288/1046

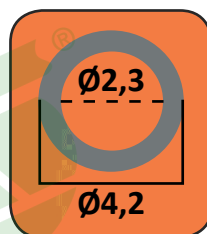
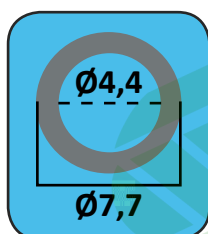

MISURA	RIF. ORIGINALE	COD.OMS
1,005	F 00R J01 010	11-23-332/1005
1,015	F 00R J01 011	11-23-332/1015
1,025	F 00R J01 012	11-23-332/1025
1,035	F 00R J01 013	11-23-332/1035
1,045	F 00R J01 014	11-23-332/1045
1,055	F 00R J01 015	11-23-332/1055
1,065	F 00R J01 016	11-23-332/1065
1,075	F 00R J01 017	11-23-332/1075
1,085	F 00R J01 018	11-23-332/1085
1,095	F 00R J01 019	11-23-332/1095
1,105	F 00R J01 020	11-23-332/1105
1,115	F 00R J01 021	11-23-332/1115

MISURA	RIF. ORIGINALE	COD.OMS
1,24	F 00R J00 126	11-23-235/124
1,25	F 00R J00 128	11-23-235/125
1,26	F 00R J00 130	11-23-235/126
1,27	F 00R J00 132	11-23-235/127
1,28	F 00R J00 134	11-23-235/128
1,29	F 00R J00 136	11-23-235/129
1,30	F 00R J00 138	11-23-235/130
1,31	F 00R J00 140	11-23-235/131
1,32	F 00R J00 142	11-23-235/132
1,33	F 00R J00 144	11-23-235/133
1,34	F 00R J00 146	11-23-235/134
1,35	F 00R J00 148	11-23-235/135

MISURA	RIF. ORIGINALE	COD.OMS
1,04	F 00R J00 192	11-23-228/104
1,06	F 00R J00 273	11-23-228/106
1,08	F 00R J00 193	11-23-228/108
1,10	F 00R J00 274	11-23-228/110
1,12	F 00R J00 194	11-23-228/112
1,14	F 00R J00 275	11-23-228/114
1,16	F 00R J00 195	11-23-228/116
1,18	F 00R J00 276	11-23-228/118
1,20	F 00R J00 196	11-23-228/120
1,22	F 00R J00 277	11-23-228/122
1,24	F 00R J00 197	11-23-228/124
1,26	F 00R J00 278	11-23-228/126

MISURA	RIF. ORIGINALE	COD.OMS
1,516	F 00R J00 871	11-23-287/1516
1,520	F 00R J00 873	11-23-287/1520
1,524	F 00R J00 875	11-23-287/1524
1,528	F 00R J00 877	11-23-287/1528
1,532	F 00R J00 879	11-23-287/1532
1,536	F 00R J00 881	11-23-287/1536
1,540	F 00R J00 883	11-23-287/1540
1,544	F 00R J00 885	11-23-287/1544
1,548	F 00R J00 887	11-23-287/1548
1,552	F 00R J00 889	11-23-287/1552
1,556	F 00R J00 891	11-23-287/1556
1,560	F 00R J00 893	11-23-287/1560
1,564	F 00R J00 895	11-23-287/1564
1,568	F 00R J00 897	11-23-287/1568
1,572	F 00R J00 899	11-23-287/1572
1,576	F 00R J00 901	11-23-287/1576
1,580	F 00R J00 903	11-23-287/1580
1,584	F 00R J00 905	11-23-287/1584
1,588	F 00R J00 907	11-23-287/1588
1,592	F 00R J00 909	11-23-287/1592
1,596	F 00R J00 911	11-23-287/1596
1,600	F 00R J00 913	11-23-287/1512
1,604	F 00R J00 915	11-23-287/1516
1,608	F 00R J00 917	11-23-287/1520
1,612	F 00R J00 919	11-23-287/1524
1,616	F 00R J00 921	11-23-287/1528
1,620	F 00R J00 923	11-23-287/1532
1,624	F 00R J00 925	11-23-287/1536
1,628	F 00R J00 927	11-23-287/1540
1,632	F 00R J00 929	11-23-287/1544
1,636	F 00R J00 931	11-23-287/1548
1,640	F 00R J00 933	11-23-287/1552
1,644	F 00R J00 935	11-23-287/1556
1,648	F 00R J00 937	11-23-287/1560
1,652	F 00R J00 939	11-23-287/1564
1,656	F 00R J00 941	11-23-287/1568

VALIGETTA COMBINATA versione OMS



COMBINED HANDBAG OMS VERSION

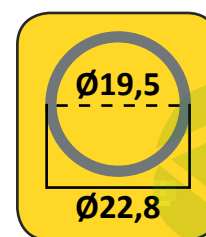
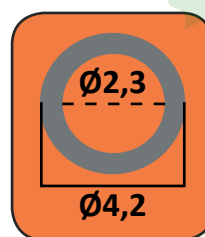
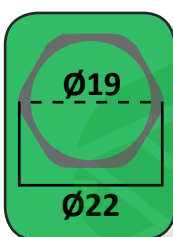
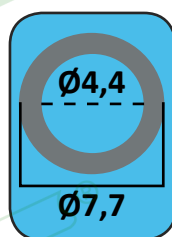
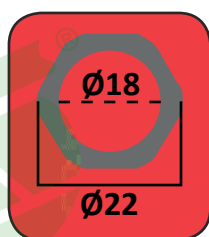

MISURA	COD.OMS
0,90	11-23-288/090
0,91	11-23-288/091
0,92	11-23-288/092
0,93	11-23-288/093
0,94	11-23-288/094
0,95	11-23-288/095
0,96	11-23-288/096
0,97	11-23-288/097
0,98	11-23-288/098
0,99	11-23-288/099
1,00	11-23-288/100
1,01	11-23-288/101
1,02	11-23-288/102
1,03	11-23-288/103
1,04	11-23-288/104
1,05	11-23-288/105
1,06	11-23-288/106
1,07	11-23-288/107
1,08	11-23-288/108
1,09	11-23-288/109
1,10	11-23-288/110
1,11	11-23-288/111
1,12	11-23-288/112
1,13	11-23-288/113

MISURA	COD.OMS
1,00	11-23-332/100
1,02	11-23-332/102
1,04	11-23-332/104
1,06	11-23-332/106
1,08	11-23-332/108
1,10	11-23-332/110
1,12	11-23-332/112
1,14	11-23-332/114
1,16	11-23-332/116
1,18	11-23-332/118
1,20	11-23-332/120
1,22	11-23-332/122

MISURA	COD.OMS
1,00	11-23-235/100
1,01	11-23-235/101
1,02	11-23-235/102
1,03	11-23-235/103
1,04	11-23-235/104
1,05	11-23-235/105
1,06	11-23-235/106
1,07	11-23-235/107
1,08	11-23-235/108
1,09	11-23-235/109
1,10	11-23-235/110
1,11	11-23-235/111

MISURA	COD.OMS
1,20	11-23-228/120
1,22	11-23-228/122
1,24	11-23-228/124
1,26	11-23-228/126
1,28	11-23-228/128
1,30	11-23-228/130
1,32	11-23-228/132
1,34	11-23-228/134
1,36	11-23-228/136
1,38	11-23-228/138
1,40	11-23-228/140
1,42	11-23-228/142
1,44	11-23-228/144
1,46	11-23-228/146
1,48	11-23-228/148
1,50	11-23-228/150
1,52	11-23-228/152
1,54	11-23-228/154
1,56	11-23-228/156
1,58	11-23-228/158
1,60	11-23-228/160
1,62	11-23-228/162
1,64	11-23-228/164
1,66	11-23-228/166

MISURA	COD.OMS
1,30	11-23-287/130
1,32	11-23-287/132
1,34	11-23-287/134
1,36	11-23-287/136
1,38	11-23-287/138
1,40	11-23-287/140
1,42	11-23-287/142
1,44	11-23-287/144
1,46	11-23-287/146
1,48	11-23-287/148
1,50	11-23-287/150
1,52	11-23-287/152
1,54	11-23-287/154
1,56	11-23-287/156
1,58	11-23-287/158
1,60	11-23-287/160
1,62	11-23-287/162
1,64	11-23-287/164
1,66	11-23-287/166
1,68	11-23-287/168
1,70	11-23-287/170
1,72	11-23-287/172
1,74	11-23-287/174
1,76	11-23-287/176



VALIGETTA COMBINATA

COMBINED HANDBAG

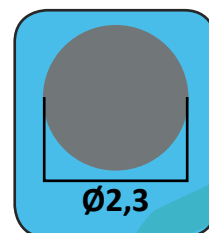
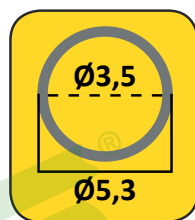
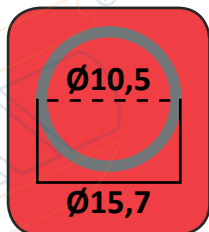

MISURA	RIF. ORIGINALE	COD. OMS
1,194	F 00V C10 402	11-23-219/1194
1,198	F 00V C10 404	11-23-219/1198
1,202	F 00V C10 406	11-23-219/1202
1,206	F 00V C10 408	11-23-219/1206
1,21	F 00V C10 410	11-23-219/121
1,214	F 00V C10 412	11-23-219/1214
1,218	F 00V C10 414	11-23-219/1218
1,222	F 00V C10 416	11-23-219/1222
1,226	F 00V C10 418	11-23-219/1226
1,23	F 00V C10 420	11-23-219/123
1,234	F 00V C10 422	11-23-219/1234
1,238	F 00V C10 424	11-23-219/1238
1,242	F 00V C10 426	11-23-219/1242
1,246	F 00V C10 428	11-23-219/1246
1,25	F 00V C10 430	11-23-219/125
1,254	F 00V C10 432	11-23-219/1254
1,258	F 00V C10 434	11-23-219/1258
1,262	F 00V C10 436	11-23-219/1262
1,266	F 00V C10 438	11-23-219/1266
1,27	F 00V C10 440	11-23-219/127
1,274	F 00V C10 442	11-23-219/1274
1,278	F 00V C10 444	11-23-219/1278
1,282	F 00V C10 446	11-23-219/1282
1,286	F 00V C10 448	11-23-219/1286

MISURA	RIF. ORIGINALE 1	RIF. ORIGINALE 2	COD. OMS
1,10	F 00V C10 470	F 00V C10 580	11-23-220/110
1,12	F 00V C10 472	F 00V C10 582	11-23-220/112
1,14	F 00V C10 474	F 00V C10 584	11-23-220/114
1,16	F 00V C10 476	F 00V C10 586	11-23-220/116
1,18	F 00V C10 478	F 00V C10 588	11-23-220/118
1,20	F 00V C10 480	F 00V C10 590	11-23-220/120
1,22	F 00V C10 482	F 00V C10 592	11-23-220/122
1,24	F 00V C10 484	F 00V C10 594	11-23-220/124
1,26	F 00V C10 486	F 00V C10 596	11-23-220/126
1,28	F 00V C10 488	F 00V C10 598	11-23-220/128
1,30	F 00V C10 490	F 00V C10 600	11-23-220/130
1,32	F 00V C10 492	F 00V C10 602	11-23-220/132
1,34	F 00V C10 494	F 00V C10 604	11-23-220/134
1,36	F 00V C10 496	F 00V C10 606	11-23-220/136
1,38	F 00V C10 498	F 00V C10 608	11-23-220/138
1,40	F 00V C10 500	F 00V C10 610	11-23-220/140
1,42	F 00V C10 502	F 00V C10 612	11-23-220/142
1,44	F 00V C10 504	F 00V C10 614	11-23-220/144
1,46	F 00V C10 506	F 00V C10 616	11-23-220/146
1,48	F 00V C10 508	F 00V C10 618	11-23-220/148
1,50	F 00V C10 510	F 00V C10 620	11-23-220/150
1,52	F 00V C10 512	F 00V C10 622	11-23-220/152
1,54	F 00V C10 514	F 00V C10 624	11-23-220/154
1,56	F 00V C10 516	F 00V C10 626	11-23-220/156
1,58	F 00V C10 518	F 00V C10 628	11-23-220/158
1,60	F 00V C10 520	F 00V C10 630	11-23-220/160
1,62	F 00V C10 522	F 00V C10 632	11-23-220/162
1,64	F 00V C10 524	F 00V C10 634	11-23-220/164
1,66	F 00V C10 526	F 00V C10 636	11-23-220/166
1,68	F 00V C10 528	F 00V C10 638	11-23-220/168
1,70	F 00V C10 530	F 00V C10 640	11-23-220/170
1,72	F 00V C10 532	F 00V C10 642	11-23-220/172
1,74	F 00V C10 534	F 00V C10 644	11-23-220/174
1,76	F 00V C10 536	F 00V C10 646	11-23-220/176
1,78	F 00V C10 538	F 00V C10 648	11-23-220/178
1,80	F 00V C10 540	F 00V C10 650	11-23-220/180

MISURA	COD. OMS
1,02	11-23-232/102
1,03	11-23-232/103
1,04	11-23-232/104
1,05	11-23-232/105
1,06	11-23-232/106
1,07	11-23-232/107
1,08	11-23-232/108
1,09	11-23-232/109
1,10	11-23-232/110
1,11	11-23-232/111
1,12	11-23-232/112
1,13	11-23-232/113
1,14	11-23-232/114
1,15	11-23-232/115
1,16	11-23-232/116
1,17	11-23-232/117
1,18	11-23-232/118
1,19	11-23-232/119
1,20	11-23-232/120
1,21	11-23-232/121
1,22	11-23-232/122
1,23	11-23-232/123
1,24	11-23-232/124
1,25	11-23-232/125

MISURA	RIF. ORIGINALE	COD. OMS
8,409	F 00V C12 444	11-23-227/8409
8,421	F 00V C12 448	11-23-227/8421
8,433	F 00V C12 452	11-23-227/8433
8,445	F 00V C12 456	11-23-227/8445
8,457	F 00V C12 460	11-23-227/8457
8,469	F 00V C12 464	11-23-227/8469
8,481	F 00V C12 468	11-23-227/8481
8,493	F 00V C12 472	11-23-227/8493
8,505	F 00V C12 476	11-23-227/8505
8,517	F 00V C12 480	11-23-227/8517
8,529	F 00V C12 484	11-23-227/8529
8,541	F 00V C12 488	11-23-227/8541

VALIGETTA COMBINATA versione OMS

COMBINED HANDBAG OMS VERSION

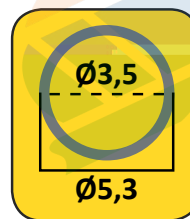
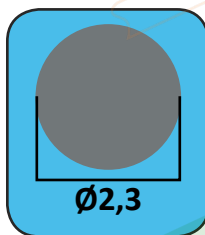
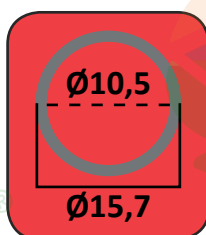

MISURA	COD. OMS
1,10	11-23-219-110
1,11	11-23-219-111
1,12	11-23-219-112
1,13	11-23-219-113
1,14	11-23-219-114
1,15	11-23-219-115
1,16	11-23-219-116
1,17	11-23-219-117
1,18	11-23-219-118
1,19	11-23-219-119
1,20	11-23-219-120
1,21	11-23-219-121
1,22	11-23-219-122
1,23	11-23-219-123
1,24	11-23-219-124
1,25	11-23-219-125
1,26	11-23-219-126
1,27	11-23-219-127
1,28	11-23-219-128
1,29	11-23-219-129
1,30	11-23-219-130
1,31	11-23-219-131
1,32	11-23-219-132
1,33	11-23-219-133

MISURA	COD. OMS
1,02	11-23-232/102
1,03	11-23-232/103
1,04	11-23-232/104
1,05	11-23-232/105
1,06	11-23-232/106
1,07	11-23-232/107
1,08	11-23-232/108
1,09	11-23-232/109
1,10	11-23-232/110
1,11	11-23-232/111
1,12	11-23-232/112
1,13	11-23-232/113
1,14	11-23-232/114
1,15	11-23-232/115
1,16	11-23-232/116
1,17	11-23-232/117
1,18	11-23-232/118
1,19	11-23-232/119
1,20	11-23-232/120
1,21	11-23-232/121
1,22	11-23-232/122
1,23	11-23-232/123
1,24	11-23-232/124
1,25	11-23-232/125

MISURA	RIF. ORIGINALE 1	RIF. ORIGINALE 2	COD. OMS
1,10	F 00V C10 470	F 00V C10 580	11-23-220/110
1,12	F 00V C10 472	F 00V C10 582	11-23-220/112
1,14	F 00V C10 474	F 00V C10 584	11-23-220/114
1,16	F 00V C10 476	F 00V C10 586	11-23-220/116
1,18	F 00V C10 478	F 00V C10 588	11-23-220/118
1,20	F 00V C10 480	F 00V C10 590	11-23-220/120
1,22	F 00V C10 482	F 00V C10 592	11-23-220/122
1,24	F 00V C10 484	F 00V C10 594	11-23-220/124
1,26	F 00V C10 486	F 00V C10 596	11-23-220/126
1,28	F 00V C10 488	F 00V C10 598	11-23-220/128
1,30	F 00V C10 490	F 00V C10 600	11-23-220/130
1,32	F 00V C10 492	F 00V C10 602	11-23-220/132
1,34	F 00V C10 494	F 00V C10 604	11-23-220/134
1,36	F 00V C10 496	F 00V C10 606	11-23-220/136
1,38	F 00V C10 498	F 00V C10 608	11-23-220/138
1,40	F 00V C10 500	F 00V C10 610	11-23-220/140
1,42	F 00V C10 502	F 00V C10 612	11-23-220/142
1,44	F 00V C10 504	F 00V C10 614	11-23-220/144
1,46	F 00V C10 506	F 00V C10 616	11-23-220/146
1,48	F 00V C10 508	F 00V C10 618	11-23-220/148
1,50	F 00V C10 510	F 00V C10 620	11-23-220/150
1,52	F 00V C10 512	F 00V C10 622	11-23-220/152
1,54	F 00V C10 514	F 00V C10 624	11-23-220/154
1,56	F 00V C10 516	F 00V C10 626	11-23-220/156
1,58	F 00V C10 518	F 00V C10 628	11-23-220/158
1,60	F 00V C10 520	F 00V C10 630	11-23-220/160
1,62	F 00V C10 522	F 00V C10 632	11-23-220/162
1,64	F 00V C10 524	F 00V C10 634	11-23-220/164
1,66	F 00V C10 526	F 00V C10 636	11-23-220/166
1,68	F 00V C10 528	F 00V C10 638	11-23-220/168
1,70	F 00V C10 530	F 00V C10 640	11-23-220/170
1,72	F 00V C10 532	F 00V C10 642	11-23-220/172
1,74	F 00V C10 534	F 00V C10 644	11-23-220/174
1,76	F 00V C10 536	F 00V C10 646	11-23-220/176
1,78	F 00V C10 538	F 00V C10 648	11-23-220/178
1,80	F 00V C10 540	F 00V C10 650	11-23-220/180

MISURA	RIF. ORIGINALE	COD. OMS
8,409	F 00V C12 444	11-23-227/8409
8,421	F 00V C12 448	11-23-227/8421
8,433	F 00V C12 452	11-23-227/8433
8,445	F 00V C12 456	11-23-227/8445
8,457	F 00V C12 460	11-23-227/8457
8,469	F 00V C12 464	11-23-227/8469
8,481	F 00V C12 468	11-23-227/8481
8,493	F 00V C12 472	11-23-227/8493
8,505	F 00V C12 476	11-23-227/8505
8,517	F 00V C12 480	11-23-227/8517
8,529	F 00V C12 484	11-23-227/8529
8,541	F 00V C12 488	11-23-227/8541

OMS SRL È LA CONTINUAZIONE DELLA DITTA INDIVIDUALE SCALVINI NATA NEL 1977 FORTE DELL'ESPERIENZA MATURATA NELLA STORICA OMAP SPA.

I PRIMI ANNI SI AFFERMA A LIVELLO MONDIALE CON INIZIALE GAMMA DI RICAMBI PER POMPE INIEZIONE MOTORI DIESEL.

OGGI OMS SRL È PRESENTE IN 60 PAESI DEL MONDO CON UN NOTEVOLE IMPULSO ALL'ESPANSIONE DATA DALLE NUOVE GAMME DI RICAMBI DI COMMON RAIL INIZIATE NEL 2008.

L'INTERO CICLO PRODUTTIVO VIENE SVOLTO COMPLETAMENTE IN ITALIA DA UNO STAFF ALTAMENTE QUALIFICATO CON PARTICOLARE ATTENZIONE A QUALITÀ, GARANZIA DEL PRODOTTO E ASSISTENZA TECNICA.

I CLIENTI DI RIFERIMENTO SONO I PIÙ ETEROGENEI; DAL MERCATO RICAMBI INDIPENDENTE (AFTERMARKET) AL RICAMBIO ORIGINALE (OES) FINO AL PRIMO IMPIANTO (OEM).



OMS SRL IS A CONTINUATION OF INDIVIDUAL OMS SCALVINI BORN IN 1977, BASED ON A GOOD EXPERIENCE IN OMAP SPA AND DEEP KNOWLEDGE OF DIESEL SPARE PARTS FOR FUEL INJECTION.

IN THE FIRST OMS WAS WELL KNOWN IN DOMESTIC MARKET, NOW IS PRESENT IN 60 COUNTRIES OF THE WORLD WITH DIESEL SPARE PARTS AND FROM 2008 WITH COMPLETE RANGE OF COMMON RAIL SPARE PARTS.

OMS PRODUCTS ARE DISTINGUISHED BY THEIR TOTAL INTERCHANGEABILITY IN TERMS OF ASSEMBLY AND PERFORMANCE, USING ORIGINAL PRODUCTS AND OFFERING TOTAL RELIABILITY GUARANTEED BY STRINGENT TESTING.

THE ENTIRE INDUSTRIAL PROCESS IS CARRIED OUT IN HOUSE, EACH STEP IN THE PROCESS BEING OVERSEEN BY HIGHLY TRAINED STAFF.

THE CUSTOMERS ARE IN THE MOST HETEROGENEOUS FROM INDEPENDENT AFTERMARKET TO THE ORIGINAL EQUIPMENT SUPPLIERS (OES) TO ORIGINAL EQUIPMENT MANUFACTURER (OEM).

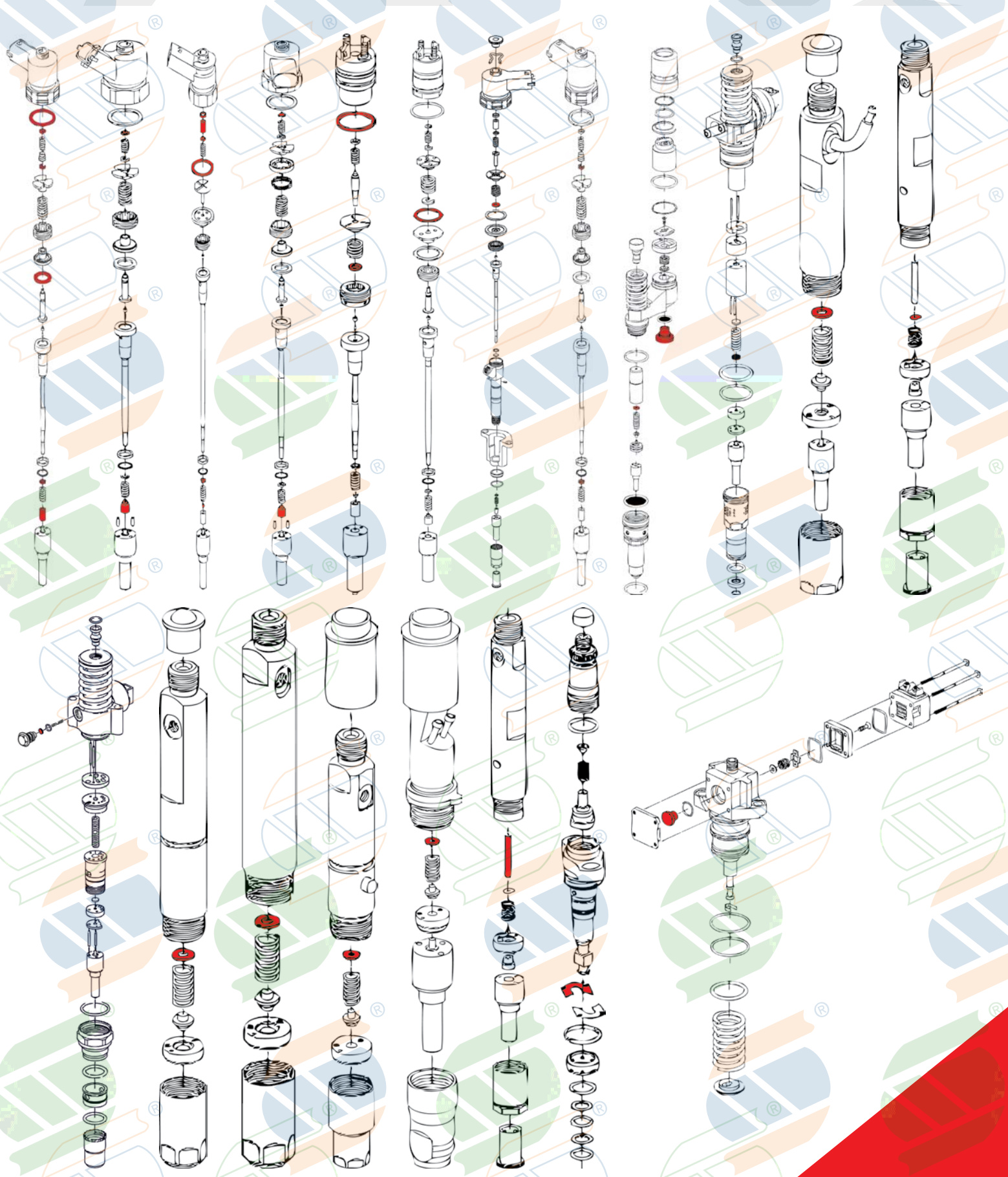

BOSCH

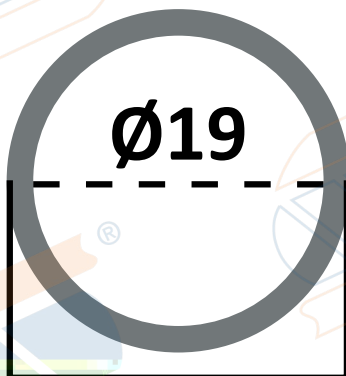
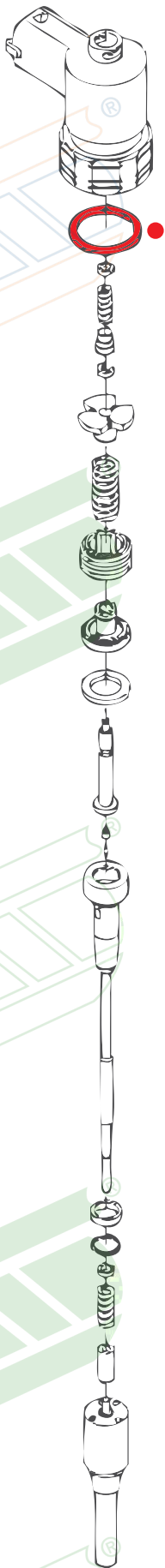

Ø23,7

da 0,90... a 2,00

ALTRE MISURE DISPONIBILI A RICHIESTA

OTHER SIZES AVAILABLE UPON REQUEST

OTROS TAMAÑOS DISPONIBLES BAJO PETICIÓN

ДРУГИЕ РАЗМЕРЫ ДОСТУПНЫ ПО ЗАПРОСУ

根據要求提供其它尺寸

CODICE OMS	SPESORE	INCREMENTO	N° PEZZI
11-23-370	DA 0,90 A 1,25	0,01	360

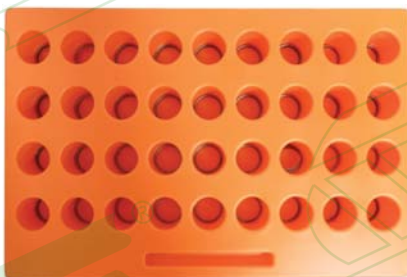

HANDBAG | VALIGETTA 36 POSIZIONI | POSITION

CODICE OMS	SPESORE	INCREMENTO	N° PEZZI
11-23-271	DA 0,90 A 1,00	0,01	110
11-23-236	DA 1,00 A 1,10	0,01	110
11-23-327	DA 1,10 A 1,20	0,01	110
11-23-743	DA 1,20 A 1,30	0,01	110
11-23-744	DA 1,30 A 1,40	0,01	110



HANDBAG | VALIGETTA 12 POSIZIONI | POSITION

MISURA	COD. OMS
1,31	11-23-236/131
1,32	11-23-236/132
1,33	11-23-236/133
1,34	11-23-236/134
1,35	11-23-236/135
1,36	11-23-236/136
1,37	11-23-236/137
1,38	11-23-236/138
1,39	11-23-236/139
1,40	11-23-236/140
1,41	11-23-236/141
1,42	11-23-236/142
1,43	11-23-236/143
1,44	11-23-236/144
1,45	11-23-236/145
1,46	11-23-236/146
1,47	11-23-236/147
1,48	11-23-236/148
1,49	11-23-236/149
1,50	11-23-236/150
1,51	11-23-236/151
1,52	11-23-236/152
1,53	11-23-236/153
1,54	11-23-236/154
1,55	11-23-236/155
1,56	11-23-236/156
1,57	11-23-236/157
1,58	11-23-236/158
1,59	11-23-236/159
1,60	11-23-236/160
1,61	11-23-236/161
1,62	11-23-236/162
1,63	11-23-236/163
1,64	11-23-236/164
1,65	11-23-236/165
1,66	11-23-236/166
1,67	11-23-236/167
1,68	11-23-236/168
1,69	11-23-236/169
1,70	11-23-236/170
1,71	11-23-236/171
1,72	11-23-236/172
1,73	11-23-236/173
1,74	11-23-236/174
1,75	11-23-236/175
1,76	11-23-236/176
1,77	11-23-236/177
1,78	11-23-236/178
1,79	11-23-236/179
1,80	11-23-236/180
1,81	11-23-236/181
1,82	11-23-236/182
1,83	11-23-236/183
1,84	11-23-236/184
1,85	11-23-236/185
1,86	11-23-236/186
1,87	11-23-236/187
1,88	11-23-236/188
1,89	11-23-236/189
1,90	11-23-236/190
1,91	11-23-236/191
1,92	11-23-236/192
1,93	11-23-236/193
1,94	11-23-236/194
1,95	11-23-236/195
1,96	11-23-236/196
1,97	11-23-236/197
1,98	11-23-236/198
1,99	11-23-236/199
2,00	11-23-236/200

CODICE SINGOLI SPESSORI CODE INDIVIDUAL THICKNESSES

MISURA	COD. OMS
0,90	11-23-236/090
0,91	11-23-236/091
0,92	11-23-236/092
0,93	11-23-236/093
0,94	11-23-236/094
0,95	11-23-236/095
0,96	11-23-236/096
0,97	11-23-236/097
0,98	11-23-236/098
0,99	11-23-236/099
1,00	11-23-236/100
1,01	11-23-236/101
1,02	11-23-236/102
1,03	11-23-236/103
1,04	11-23-236/104
1,05	11-23-236/105
1,06	11-23-236/106
1,07	11-23-236/107
1,08	11-23-236/108
1,09	11-23-236/109
1,10	11-23-236/110
1,11	11-23-236/111
1,12	11-23-236/112
1,13	11-23-236/113
1,14	11-23-236/114
1,15	11-23-236/115
1,16	11-23-236/116
1,17	11-23-236/117
1,18	11-23-236/118
1,19	11-23-236/119
1,20	11-23-236/120
1,21	11-23-236/121
1,22	11-23-236/122
1,23	11-23-236/123
1,24	11-23-236/124
1,25	11-23-236/125
1,26	11-23-236/126
1,27	11-23-236/127
1,28	11-23-236/128
1,29	11-23-236/129
1,30	11-23-236/130



BOSCH

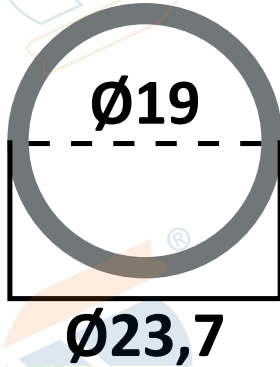

Ø23,7

CODICE OMS	SPESORE	INCREMENTO	N° PEZZI
11-23-350	DA 0,86 A 1,24	0,004	960

HANDBAG | VALIGETTA 96 POSIZIONI | POSITION

da 0,860... a 1,240
 ALTRE MISURE DISPONIBILI A RICHIESTA
 OTHER SIZES AVAILABLE UPON REQUEST
 OTROS TAMAÑOS DISPONIBLES BAJO PETICIÓN
 ДРУГИЕ РАЗМЕРЫ ДОСТУПНЫ ПО ЗАПРОСУ
 根據要求提供其它尺寸

TABELLA CODICI ORIGINALI ORIGINAL CODES TABLE

MISURA	RIF. ORIGINALE	RIF. ORIGINALE NEW	COD. OMS	MISURA	RIF. ORIGINALE	RIF. ORIGINALE NEW	COD. OMS
0,86	F 00V C60 175	F 00Z C99 300	11-23-236/086	1,052	F 00V C60 271	F 00Z C99 348	11-23-236/1052
0,864	F 00V C60 177	F 00Z C99 301	11-23-236/0864	1,056	F 00V C60 273	F 00Z C99 349	11-23-236/1056
0,868	F 00V C60 179	F 00Z C99 302	11-23-236/0868	1,06	F 00V C60 275	F 00Z C99 350	11-23-236/106
0,872	F 00V C60 181	F 00Z C99 303	11-23-236/0872	1,064	F 00V C60 277	F 00Z C99 351	11-23-236/1064
0,876	F 00V C60 183	F 00Z C99 304	11-23-236/0876	1,068	F 00V C60 279	F 00Z C99 352	11-23-236/1068
0,88	F 00V C60 185	F 00Z C99 305	11-23-236/088	1,072	F 00V C60 281	F 00Z C99 353	11-23-236/1072
0,884	F 00V C60 187	F 00Z C99 306	11-23-236/0884	1,076	F 00V C60 283	F 00Z C99 354	11-23-236/1076
0,888	F 00V C60 189	F 00Z C99 307	11-23-236/0888	1,08	F 00V C60 285	F 00Z C99 355	11-23-236/108
0,892	F 00V C60 191	F 00Z C99 308	11-23-236/0892	1,084	F 00V C60 287	F 00Z C99 356	11-23-236/1084
0,896	F 00V C60 193	F 00Z C99 309	11-23-236/0896	1,088	F 00V C60 289	F 00Z C99 357	11-23-236/1088
0,90	F 00V C60 195	F 00Z C99 310	11-23-236/090	1,092	F 00V C60 291	F 00Z C99 358	11-23-236/1092
0,904	F 00V C60 197	F 00Z C99 311	11-23-236/0904	1,096	F 00V C60 293	F 00Z C99 359	11-23-236/1096
0,908	F 00V C60 199	F 00Z C99 312	11-23-236/0908	1,10	F 00V C60 295	F 00Z C99 360	11-23-236/110
0,912	F 00V C60 201	F 00Z C99 313	11-23-236/0912	1,104	F 00V C60 297	F 00Z C99 361	11-23-236/1104
0,916	F 00V C60 203	F 00Z C99 314	11-23-236/0916	1,108	F 00V C60 299	F 00Z C99 362	11-23-236/1108
0,92	F 00V C60 205	F 00Z C99 315	11-23-236/092	1,112	F 00V C60 301	F 00Z C99 363	11-23-236/1112
0,924	F 00V C60 207	F 00Z C99 316	11-23-236/0924	1,116	F 00V C60 303	F 00Z C99 364	11-23-236/1116
0,928	F 00V C60 209	F 00Z C99 317	11-23-236/0928	1,12	F 00V C60 305	F 00Z C99 365	11-23-236/112
0,932	F 00V C60 211	F 00Z C99 318	11-23-236/0932	1,124	F 00V C60 307	F 00Z C99 366	11-23-236/1124
0,936	F 00V C60 213	F 00Z C99 319	11-23-236/0936	1,128	F 00V C60 309	F 00Z C99 367	11-23-236/1128
0,94	F 00V C60 215	F 00Z C99 320	11-23-236/094	1,132	F 00V C60 311	F 00Z C99 368	11-23-236/1132
0,944	F 00V C60 217	F 00Z C99 321	11-23-236/0944	1,136	F 00V C60 313	F 00Z C99 369	11-23-236/1136
0,948	F 00V C60 219	F 00Z C99 322	11-23-236/0948	1,14	F 00V C60 315	F 00Z C99 370	11-23-236/114
0,952	F 00V C60 221	F 00Z C99 323	11-23-236/0952	1,144	F 00V C60 317	F 00Z C99 371	11-23-236/1144
0,956	F 00V C60 223	F 00Z C99 324	11-23-236/0956	1,148	F 00V C60 319	F 00Z C99 372	11-23-236/1148
0,96	F 00V C60 225	F 00Z C99 325	11-23-236/096	1,152	F 00V C60 321	F 00Z C99 373	11-23-236/1152
0,964	F 00V C60 227	F 00Z C99 326	11-23-236/0964	1,156	F 00V C60 323	F 00Z C99 374	11-23-236/1156
0,968	F 00V C60 229	F 00Z C99 327	11-23-236/0968	1,16	F 00V C60 325	F 00Z C99 375	11-23-236/116
0,972	F 00V C60 231	F 00Z C99 328	11-23-236/0972	1,164	F 00V C60 327	F 00Z C99 376	11-23-236/1164
0,976	F 00V C60 233	F 00Z C99 329	11-23-236/0976	1,168	F 00V C60 329	F 00Z C99 377	11-23-236/1168
0,98	F 00V C60 235	F 00Z C99 330	11-23-236/098	1,172	F 00V C60 331	F 00Z C99 378	11-23-236/1172
0,984	F 00V C60 237	F 00Z C99 331	11-23-236/0984	1,176	F 00V C60 333	F 00Z C99 379	11-23-236/1176
0,988	F 00V C60 239	F 00Z C99 332	11-23-236/0988	1,18	F 00V C60 335	F 00Z C99 380	11-23-236/118
0,992	F 00V C60 241	F 00Z C99 333	11-23-236/0992	1,184	F 00V C60 337	F 00Z C99 381	11-23-236/1184
0,996	F 00V C60 243	F 00Z C99 334	11-23-236/0996	1,188	F 00V C60 339	F 00Z C99 382	11-23-236/1188
1,00	F 00V C60 245	F 00Z C99 335	11-23-236/100	1,192	F 00V C60 341	F 00Z C99 383	11-23-236/1192
1,004	F 00V C60 247	F 00Z C99 336	11-23-236/1004	1,196	F 00V C60 343	F 00Z C99 384	11-23-236/1196
1,008	F 00V C60 249	F 00Z C99 337	11-23-236/1008	1,20	F 00V C60 345	F 00Z C99 385	11-23-236/120
1,012	F 00V C60 251	F 00Z C99 338	11-23-236/1012	1,204	F 00V C60 347	F 00Z C99 386	11-23-236/1204
1,016	F 00V C60 253	F 00Z C99 339	11-23-236/1016	1,208	F 00V C60 349	F 00Z C99 387	11-23-236/1208
1,02	F 00V C60 255	F 00Z C99 340	11-23-236/102	1,212	F 00V C60 351	F 00Z C99 388	11-23-236/1212
1,024	F 00V C60 257	F 00Z C99 341	11-23-236/1024	1,216	F 00V C60 353	F 00Z C99 389	11-23-236/1216
1,028	F 00V C60 259	F 00Z C99 342	11-23-236/1028	1,22	F 00V C60 355	F 00Z C99 390	11-23-236/122
1,032	F 00V C60 261	F 00Z C99 343	11-23-236/1032	1,224	F 00V C60 357	F 00Z C99 391	11-23-236/1224
1,036	F 00V C60 263	F 00Z C99 344	11-23-236/1036	1,228	F 00V C60 359	F 00Z C99 392	11-23-236/1228
1,04	F 00V C60 265	F 00Z C99 345	11-23-236/104	1,232	F 00V C60 361	F 00Z C99 393	11-23-236/1232
1,044	F 00V C60 267	F 00Z C99 346	11-23-236/1044	1,236	F 00V C60 363	F 00Z C99 394	11-23-236/1236
1,048	F 00V C60 269	F 00Z C99 347	11-23-236/1048	1,24	F 00V C60 365	F 00Z C99 395	11-23-236/124



COMMON RAIL

BOSCH

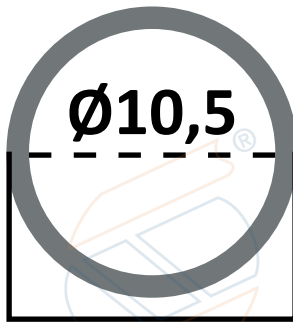

Ø15,7

da 1,00... a 1,40

ALTRE MISURE DISPONIBILI A RICHIESTA
OTHER SIZES AVAILABLE UPON REQUEST
OTROS TAMAÑOS DISPONIBLES BAJO PETICIÓN
ДРУГИЕ РАЗМЕРЫ ДОСТУПНЫ ПО ЗАПРОСУ
根據要求提供其它尺寸

CODICE OMS	SPESORE	INCREMENTO	N° PEZZI
11-23-285	DA 1,10 A 1,20	0,01	110
11-23-219	DA 1,20 A 1,30	0,01	110



HANDBAG | VALIGETTA 12 POSIZIONI | POSITION

CODICE OMS	SPESORE	INCREMENTO	N° PEZZI
11-23-371	DA 1,10 A 1,33	0,01	240



HANDBAG | VALIGETTA 24 POSIZIONI | POSITION

CODICE OMS	SPESORE	INCREMENTO	N° PEZZI
11-23-372	DA 1,00 A 1,33	0,01	340

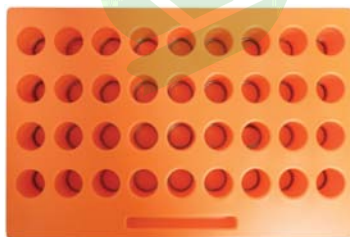

HANDBAG | VALIGETTA 36 POSIZIONI | POSITION

CODICE SINGOLI SPESSORI CODE INDIVIDUAL THICKNESSES

MISURA	COD. OMS
1,00	11-23-219/100
1,01	11-23-219/101
1,02	11-23-219/102
1,03	11-23-219/103
1,04	11-23-219/104
1,05	11-23-219/105
1,06	11-23-219/106
1,07	11-23-219/107
1,08	11-23-219/108
1,09	11-23-219/109
1,10	11-23-219/110
1,11	11-23-219/111
1,12	11-23-219/112
1,13	11-23-219/113
1,14	11-23-219/114
1,15	11-23-219/115
1,16	11-23-219/116
1,17	11-23-219/117
1,18	11-23-219/118
1,19	11-23-219/119
1,20	11-23-219/120
1,21	11-23-219/121
1,22	11-23-219/122
1,23	11-23-219/123
1,24	11-23-219/124
1,25	11-23-219/125
1,26	11-23-219/126
1,27	11-23-219/127
1,28	11-23-219/128
1,29	11-23-219/129
1,30	11-23-219/130
1,31	11-23-219/131
1,32	11-23-219/132
1,33	11-23-219/133
1,34	11-23-219/134
1,35	11-23-219/135
1,36	11-23-219/136
1,37	11-23-219/137
1,38	11-23-219/138
1,39	11-23-219/139
1,40	11-23-219/140



Ø10,5

Ø15,7

da 1,19... a 1,33

ALTRE MISURE DISPONIBILI A RICHIESTA
OTHER SIZES AVAILABLE UPON REQUEST
OTROS TAMAÑOS DISPONIBLES BAJO PETICIÓN
ДРУГИЕ РАЗМЕРЫ ДОСТУПНЫ ПО ЗАПРОСУ
根據要求提供其它尺寸

TABELLA CODICI ORIGINALI
ORIGINAL CODES TABLE

MISURA	RIF. ORIGINALE	RIF. ORIGINALE NEW	COD. OMS
1,19	F 00V C10 400	F 00Z C99 396	11-23-219/119
1,194	F 00V C10 402	F 00Z C99 397	11-23-219/1194
1,198	F 00V C10 404	F 00Z C99 398	11-23-219/1198
1,202	F 00V C10 406	F 00Z C99 399	11-23-219/1202
1,206	F 00V C10 408	F 00Z C99 400	11-23-219/1206
1,21	F 00V C10 410	F 00Z C99 401	11-23-219/121
1,214	F 00V C10 412	F 00Z C99 402	11-23-219/1214
1,218	F 00V C10 414	F 00Z C99 403	11-23-219/1218
1,222	F 00V C10 416	F 00Z C99 404	11-23-219/1222
1,226	F 00V C10 418	F 00Z C99 405	11-23-219/1226
1,23	F 00V C10 420	F 00Z C99 406	11-23-219/123
1,234	F 00V C10 422	F 00Z C99 407	11-23-219/1234
1,238	F 00V C10 424	F 00Z C99 408	11-23-219/1238
1,242	F 00V C10 426	F 00Z C99 409	11-23-219/1242
1,246	F 00V C10 428	F 00Z C99 410	11-23-219/1246
1,25	F 00V C10 430	F 00Z C99 411	11-23-219/125
1,254	F 00V C10 432	F 00Z C99 412	11-23-219/1254
1,258	F 00V C10 434	F 00Z C99 413	11-23-219/1258
1,262	F 00V C10 436	F 00Z C99 414	11-23-219/1262
1,266	F 00V C10 438	F 00Z C99 415	11-23-219/1266
1,27	F 00V C10 440	F 00Z C99 416	11-23-219/127
1,274	F 00V C10 442	F 00Z C99 417	11-23-219/1274
1,278	F 00V C10 444	F 00Z C99 418	11-23-219/1278
1,282	F 00V C10 446	F 00Z C99 419	11-23-219/1282
1,286	F 00V C10 448	F 00Z C99 420	11-23-219/1286
1,29	F 00V C10 450	F 00Z C99 421	11-23-219/129
1,294	F 00V C10 452	F 00Z C99 422	11-23-219/1294
1,298	-	-	11-23-219/1298
1,302	-	-	11-23-219/1302
1,306	-	-	11-23-219/1306
1,310	-	-	11-23-219/460
1,314	-	-	11-23-219/1314
1,318	-	-	11-23-219/1318
1,322	-	-	11-23-219/1322
1,326	-	-	11-23-219/1326
1,330	-	-	11-23-219/1330

CODICE OMS	SPESSORE	INCREMENTO	N° PEZZI
11-23-373	DA 1,19 A 1,33	0,004	360

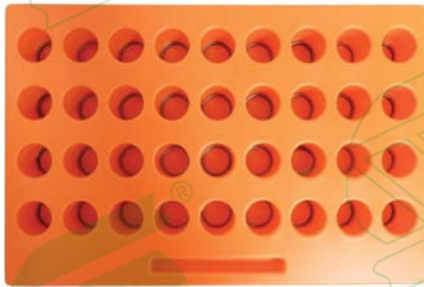

HANDBAG | VALIGETTA 36 POSIZIONI | POSITION



COMMON RAIL

BOSCH

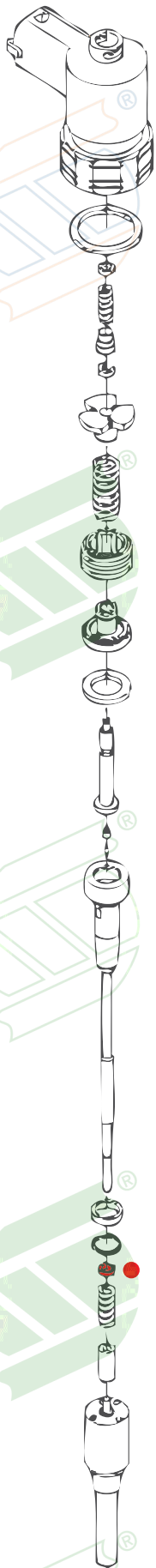

CODICE OMS	SPESORE	INCREMENTO	N° PEZZI
11-23-244	DA 1,20 A 1,70	0,05	110
11-23-729	DA 1,20 A 2,30	0,10	120



HANDBAG | VALIGETTA 12 POSIZIONI | POSITION

CODICE OMS	SPESORE	INCREMENTO	N° PEZZI
11-23-269	DA 0,90 A 1,90	0,05	210
11-23-220	DA 1,20 A 1,70	0,02	240
11-23-264	DA 1,40 A 1,86	0,02	240
11-23-748	DA 1,15 A 2,30	0,05	240
11-23-730	DA 1,20 A 2,30	0,05	230
11-23-951	DA 1,00 A 1,68	0,04	180

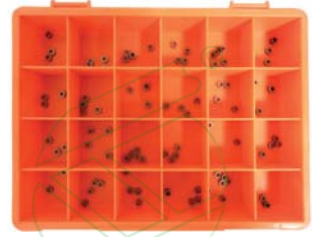

HANDBAG | VALIGETTA 24 POSIZIONI | POSITION

CODICE OMS	SPESORE	INCREMENTO	N° PEZZI
11-23-374	DA 1,00 A 2,00	0,02	510

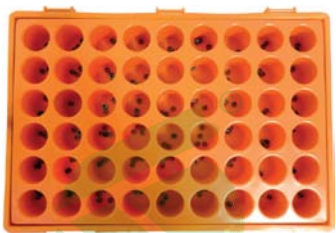

HANDBAG | VALIGETTA 54 POSIZIONI | POSITION

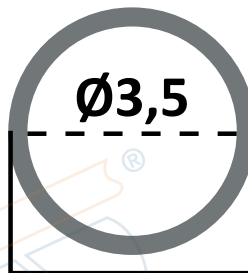

Ø5,3

da 0,90... a 2,30

ALTRE MISURE DISPONIBILI A RICHIESTA
OTHER SIZES AVAILABLE UPON REQUEST
OTROS TAMAÑOS DISPONIBLES BAJO PETICIÓN
ДРУГИЕ РАЗМЕРЫ ДОСТУПНЫ ПО ЗАПРОСУ
根據要求提供其它尺寸

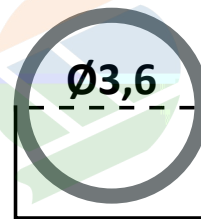
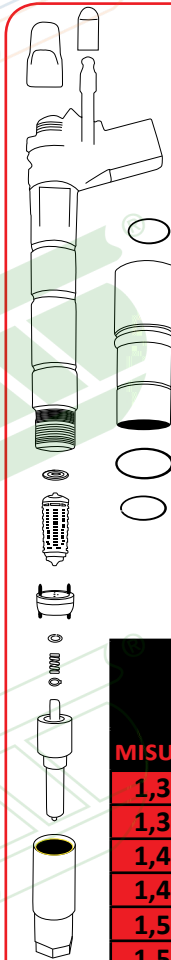

Ø5,3

CODICE OMS	SPESORE	INCREMENTO	N° PEZZI
11-23-220/P	DA 1,30 A 1,85	0,05	120

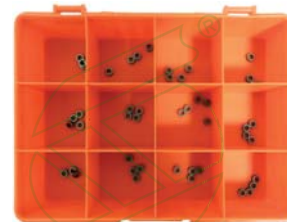

HANDBAG | VALIGETTA 12 POSIZIONI | POSITION

**ADATTABILE A BOSCH C/R PIEZO
SUITABLE ON BOSCH C/R PIEZO**

MISURA	COD. OMS	MISURA	COD. OMS
1,30	11-23-220/P130	1,60	11-23-220/P160
1,35	11-23-220/P135	1,65	11-23-220/P165
1,40	11-23-220/P140	1,70	11-23-220/P170
1,45	11-23-220/P145	1,75	11-23-220/P175
1,50	11-23-220/P150	1,80	11-23-220/P180
1,55	11-23-220/P155	1,85	11-23-220/P185

TABELLA CODICI ORIGINALI ORIGINAL CODES TABLE

MISURA	RIF. ORIGINALE	RIF. ORIGINALE 2	RIF. ORIGINALE NEW	COD. OMS
0,90	-	-	-	11-23-220/090
0,92	-	-	-	11-23-220/092
0,94	-	-	-	11-23-220/094
0,95	-	-	-	11-23-220/095
0,96	-	-	-	11-23-220/096
0,98	-	-	-	11-23-220/098
1,00	F 00V C10 460	F 00V C10 570	F 00Z C99 057	11-23-220/100
1,02	F 00V C10 462	F 00V C10 572	F 00Z C99 058	11-23-220/102
1,04	F 00V C10 464	F 00V C10 574	F 00Z C99 059	11-23-220/104
1,05	-	-	-	11-23-220/105
1,06	F 00V C10 466	F 00V C10 576	F 00Z C99 060	11-23-220/106
1,08	F 00V C10 468	F 00V C10 578	F 00Z C99 061	11-23-220/108
1,10	F 00V C10 470	F 00V C10 580	F 00Z C99 062	11-23-220/110
1,12	F 00V C10 472	F 00V C10 582	F 00Z C99 063	11-23-220/112
1,14	F 00V C10 474	F 00V C10 584	F 00Z C99 064	11-23-220/114
1,15	-	-	-	11-23-220/115



BOSCH

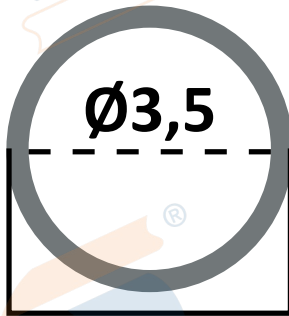
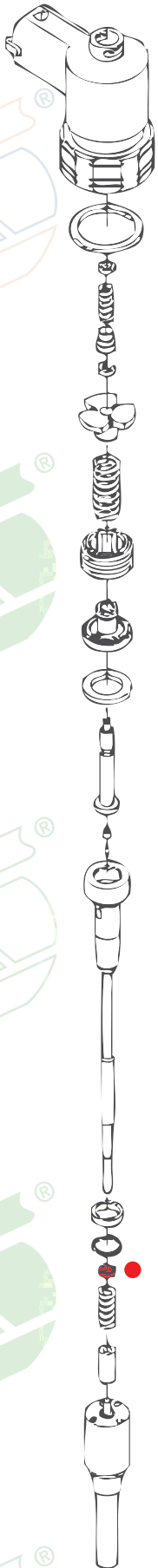

Ø5,3

MISURA	RIF. ORIGINALE	RIF. ORIGINALE 2	RIF. ORIGINALE NEW	COD. OMS
1,16	F 00V C10 476	F 00V C10 586	F 00Z C99 065	11-23-220/116
1,18	F 00V C10 478	F 00V C10 588	F 00Z C99 066	11-23-220/118
1,20	F 00V C10 480	F 00V C10 590	F 00Z C99 067	11-23-220/120
1,22	F 00V C10 482	F 00V C10 592	F 00Z C99 068	11-23-220/122
1,24	F 00V C10 484	F 00V C10 594	F 00Z C99 069	11-23-220/124
1,25	-	-	-	11-23-220/125
1,26	F 00V C10 486	F 00V C10 596	F 00Z C99 070	11-23-220/126
1,28	F 00V C10 488	F 00V C10 598	F 00Z C99 071	11-23-220/128
1,30	F 00V C10 490	F 00V C10 600	F 00Z C99 072	11-23-220/130
1,32	F 00V C10 492	F 00V C10 602	F 00Z C99 073	11-23-220/132
1,34	F 00V C10 494	F 00V C10 604	F 00Z C99 074	11-23-220/134
1,35	-	-	-	11-23-220/135
1,36	F 00V C10 496	F 00V C10 606	F 00Z C99 075	11-23-220/136
1,38	F 00V C10 498	F 00V C10 608	F 00Z C99 076	11-23-220/138
1,40	F 00V C10 500	F 00V C10 610	F 00Z C99 077	11-23-220/140
1,42	F 00V C10 502	F 00V C10 612	F 00Z C99 078	11-23-220/142
1,44	F 00V C10 504	F 00V C10 614	F 00Z C99 079	11-23-220/144
1,45	-	-	-	11-23-220/145
1,46	F 00V C10 506	F 00V C10 616	F 00Z C99 080	11-23-220/146
1,48	F 00V C10 508	F 00V C10 618	F 00Z C99 081	11-23-220/148
1,50	F 00V C10 510	F 00V C10 620	F 00Z C99 082	11-23-220/150
1,52	F 00V C10 512	F 00V C10 622	F 00Z C99 083	11-23-220/152
1,54	F 00V C10 514	F 00V C10 624	F 00Z C99 084	11-23-220/154
1,55	-	-	-	11-23-220/155
1,56	F 00V C10 516	F 00V C10 626	F 00Z C99 085	11-23-220/156
1,58	F 00V C10 518	F 00V C10 628	F 00Z C99 086	11-23-220/158
1,60	F 00V C10 520	F 00V C10 630	F 00Z C99 087	11-23-220/160
1,62	F 00V C10 522	F 00V C10 632	F 00Z C99 088	11-23-220/162
1,64	F 00V C10 524	F 00V C10 634	F 00Z C99 089	11-23-220/164
1,65	-	-	-	11-23-220/165
1,66	F 00V C10 526	F 00V C10 636	F 00Z C99 090	11-23-220/166
1,68	F 00V C10 528	F 00V C10 638	F 00Z C99 091	11-23-220/168
1,70	F 00V C10 530	F 00V C10 640	F 00Z C99 092	11-23-220/170
1,72	F 00V C10 532	F 00V C10 642	F 00Z C99 093	11-23-220/172
1,74	F 00V C10 534	F 00V C10 644	F 00Z C99 094	11-23-220/174
1,75	-	-	-	11-23-220/175
1,76	F 00V C10 536	F 00V C10 646	F 00Z C99 095	11-23-220/176
1,78	F 00V C10 538	F 00V C10 648	F 00Z C99 096	11-23-220/178
1,80	F 00V C10 540	F 00V C10 650	F 00Z C99 097	11-23-220/180
1,82	F 00V C10 542	F 00V C10 652	F 00Z C99 098	11-23-220/182
1,84	F 00V C10 544	F 00V C10 654	F 00Z C99 099	11-23-220/184
1,85	-	-	-	11-23-220/185
1,86	F 00V C10 546	F 00V C10 656	F 00Z C99 100	11-23-220/186
1,88	F 00V C10 548	F 00V C10 658	F 00Z C99 101	11-23-220/188
1,90	F 00V C10 550	F 00V C10 660	F 00Z C99 102	11-23-220/190
1,92	F 00V C10 552	F 00V C10 662	F 00Z C99 103	11-23-220/192
1,94	F 00V C10 554	F 00V C10 664	F 00Z C99 104	11-23-220/194
1,95	-	-	-	11-23-220/195
1,96	F 00V C10 556	F 00V C10 666	F 00Z C99 105	11-23-220/196
1,98	F 00V C10 558	F 00V C10 668	F 00Z C99 106	11-23-220/198
2,00	F 00V C10 560	F 00V C10 670	F 00Z C99 107	11-23-220/200
2,02	-	-	-	11-23-220/202
2,04	-	-	-	11-23-220/204
2,05	-	-	-	11-23-220/205
2,06	-	-	-	11-23-220/206
2,08	-	-	-	11-23-220/208
2,10	-	-	-	11-23-220/210
2,12	-	-	-	11-23-220/212
2,14	-	-	-	11-23-220/214
2,15	-	-	-	11-23-220/215
2,16	-	-	-	11-23-220/216
2,18	-	-	-	11-23-220/218
2,20	-	-	-	11-23-220/220
2,22	-	-	-	11-23-220/222
2,24	-	-	-	11-23-220/224
2,25	-	-	-	11-23-220/225
2,26	-	-	-	11-23-220/226
2,28	-	-	-	11-23-220/228
2,30	-	-	-	11-23-220/230



COMMON RAIL

BOSCH

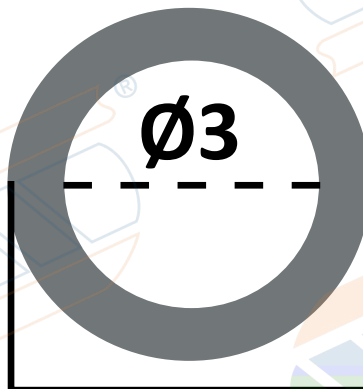
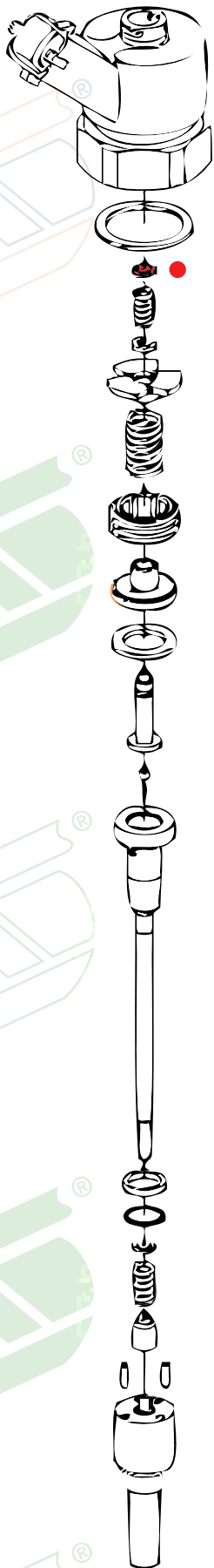

Ø5,1

da 1,00... a 2,30
 ALTRE MISURE DISPONIBILI A RICHIESTA
 OTHER SIZES AVAILABLE UPON REQUEST
 OTROS TAMAÑOS DISPONIBLES BAJO PETICIÓN
 ДРУГИЕ РАЗМЕРЫ ДОСТУПНЫ ПО ЗАПРОСУ
 根據要求提供其它尺寸

CODICE OMS	SPESSORE	INCREMENTO	N° PEZZI
11-23-334	DA 1,00 A 1,20	0,02	110

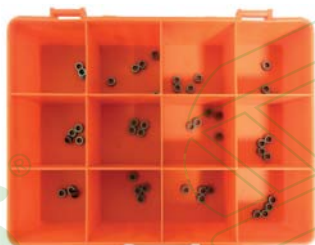

HANDBAG | VALIGETTA 12 POSIZIONI | POSITION

CODICE OMS	SPESSORE	INCREMENTO	N° PEZZI
11-23-352	DA 1,00 A 1,70	0,02	360



HANDBAG | VALIGETTA 36 POSIZIONI | POSITION

CODICE OMS	SPESSORE	INCREMENTO	N° PEZZI
11-23-330	DA 1,60 A 1,86	0,02	140
11-23-731	DA 1,15 A 2,30	0,05	240
11-23-732	DA 1,20 A 1,60	0,02	210

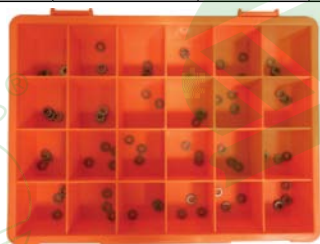

HANDBAG | VALIGETTA 24 POSIZIONI | POSITION

CODICE OMS	SPESSORE	INCREMENTO	N° PEZZI
11-23-375	DA 1,00 A 2,00	0,02	510

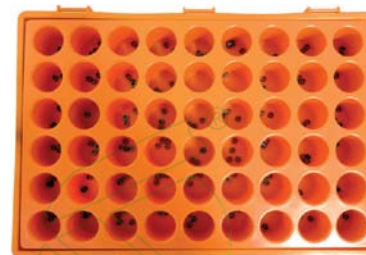

HANDBAG | VALIGETTA 54 POSIZIONI | POSITION



BOSCH

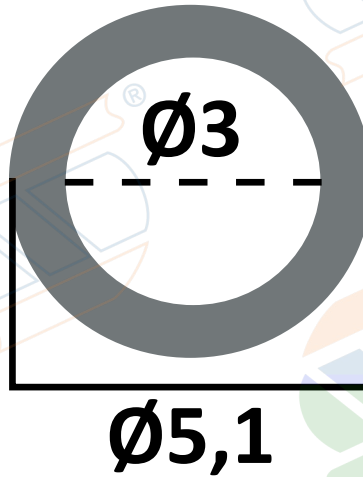
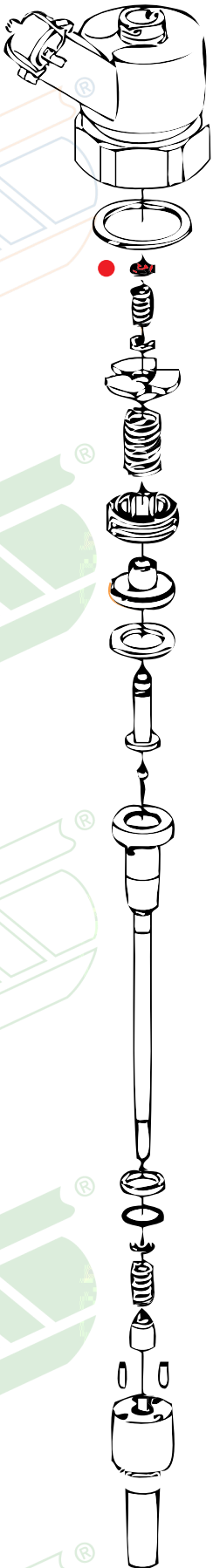

TABELLA CODICI ORIGINALI
ORIGINAL CODES TABLE

MISURA	RIF. ORIGINALE	RIF. ORIGINALE NEW	COD. OMS	MISURA	RIF. ORIGINALE	RIF. ORIGINALE NEW	COD. OMS
1,00	F 00V C60 550	F 00Z C99 211	11-23-330/100	1,56	F 00V C60 606	F 00Z C99 239	11-23-330/156
1,02	F 00V C60 552	F 00Z C99 212	11-23-330/102	1,58	F 00V C60 608	F 00Z C99 240	11-23-330/158
1,04	F 00V C60 554	F 00Z C99 213	11-23-330/104	1,60	F 00V C60 610	F 00Z C99 241	11-23-330/160
1,05	-	-	11-23-330/105	1,62	F 00V C60 612	F 00Z C99 242	11-23-330/162
1,06	F 00V C60 556	F 00Z C99 214	11-23-330/106	1,64	F 00V C60 614	F 00Z C99 243	11-23-330/164
1,08	F 00V C60 558	F 00Z C99 215	11-23-330/108	1,65	-	-	11-23-330/165
1,10	F 00V C60 560	F 00Z C99 216	11-23-330/110	1,66	F 00V C60 616	F 00Z C99 244	11-23-330/166
1,12	F 00V C60 562	F 00Z C99 217	11-23-330/112	1,68	F 00V C60 618	F 00Z C99 245	11-23-330/168
1,14	F 00V C60 564	F 00Z C99 218	11-23-330/114	1,70	F 00V C60 620	F 00Z C99 246	11-23-330/170
1,15	-	-	11-23-330/115	1,72	F 00V C60 622	F 00Z C99 247	11-23-330/172
1,16	F 00V C60 566	F 00Z C99 219	11-23-330/116	1,74	F 00V C60 624	F 00Z C99 248	11-23-330/174
1,18	F 00V C60 568	F 00Z C99 220	11-23-330/118	1,75	-	-	11-23-330/175
1,20	F 00V C60 570	F 00Z C99 221	11-23-330/120	1,76	F 00V C60 626	F 00Z C99 249	11-23-330/176
1,22	F 00V C60 572	F 00Z C99 222	11-23-330/122	1,78	F 00V C60 628	F 00Z C99 250	11-23-330/178
1,24	F 00V C60 574	F 00Z C99 223	11-23-330/124	1,80	F 00V C60 630	F 00Z C99 251	11-23-330/180
1,25	-	-	11-23-330/125	1,82	F 00V C60 632	F 00Z C99 252	11-23-330/182
1,26	F 00V C60 576	F 00Z C99 224	11-23-330/126	1,84	F 00V C60 634	F 00Z C99 253	11-23-330/184
1,28	F 00V C60 578	F 00Z C99 225	11-23-330/128	1,85	-	-	11-23-330/185
1,30	F 00V C60 580	F 00Z C99 226	11-23-330/130	1,86	F 00V C60 636	F 00Z C99 254	11-23-330/186
1,32	F 00V C60 582	F 00Z C99 227	11-23-330/132	1,88	F 00V C60 638	F 00Z C99 255	11-23-330/188
1,34	F 00V C60 584	F 00Z C99 228	11-23-330/134	1,90	F 00V C60 640	F 00Z C99 256	11-23-330/190
1,35	-	-	11-23-330/135	1,92	F 00V C60 642	F 00Z C99 257	11-23-330/192
1,36	F 00V C60 586	F 00Z C99 229	11-23-330/136	1,94	F 00V C60 644	F 00Z C99 258	11-23-330/194
1,38	F 00V C60 588	F 00Z C99 230	11-23-330/138	1,95	-	-	11-23-330/195
1,40	F 00V C60 590	F 00Z C99 231	11-23-330/140	1,96	F 00V C60 646	F 00Z C99 259	11-23-330/196
1,42	F 00V C60 592	F 00Z C99 232	11-23-330/142	1,98	F 00V C60 648	F 00Z C99 260	11-23-330/198
1,44	F 00V C60 594	F 00Z C99 233	11-23-330/144	2,00	F 00V C60 650	F 00Z C99 261	11-23-330/200
1,45	-	-	11-23-330/144	2,05	-	-	11-23-330/205
1,46	F 00V C60 596	F 00Z C99 234	11-23-330/146	2,10	-	-	11-23-330/210
1,48	F 00V C60 598	F 00Z C99 235	11-23-330/148	2,15	-	-	11-23-330/215
1,50	F 00V C60 600	F 00Z C99 236	11-23-330/150	2,20	-	-	11-23-330/220
1,52	F 00V C60 602	F 00Z C99 237	11-23-330/152	2,25	-	-	11-23-330/225
1,54	F 00V C60 604	F 00Z C99 238	11-23-330/154	2,30	-	-	11-23-330/230
1,55	-	-	11-23-330/155				

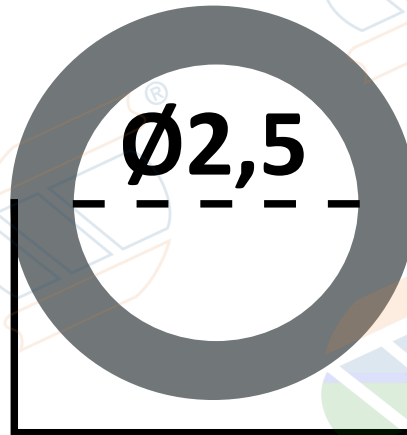
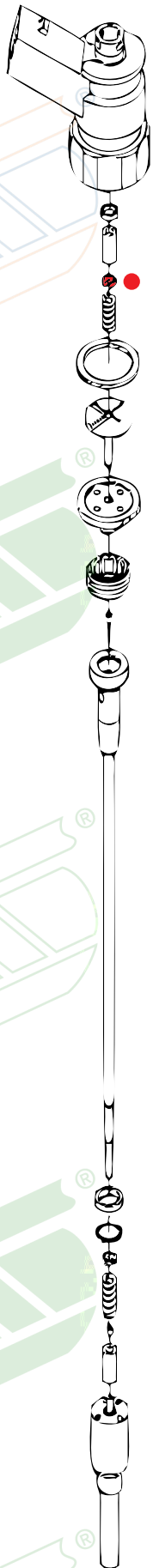

COMMON RAIL

BOSCH



Ø4,5

da 0,90... a 2,10

ALTRE MISURE DISPONIBILI A RICHIESTA
OTHER SIZES AVAILABLE UPON REQUEST
OTROS TAMAÑOS DISPONIBLES BAJO PETICIÓN
ДРУГИЕ РАЗМЕРЫ ДОСТУПНЫ ПО ЗАПРОСУ
根據要求提供其它尺寸

CODICE OMS	SPESSORE	INCREMENTO	N° PEZZI
11-23-245	DA 1,20 A 1,70	0,05	110
11-23-263	DA 1,64 A 1,86	0,02	120

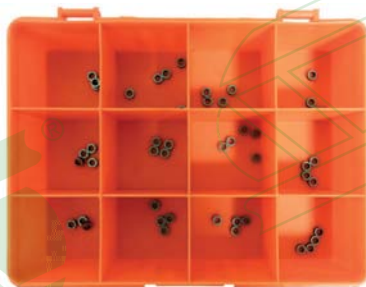

HANDBAG | VALIGETTA 12 POSIZIONI | POSITION

CODICE OMS	SPESSORE	INCREMENTO	N° PEZZI
11-23-230	DA 1,20 A 1,70	0,02	240

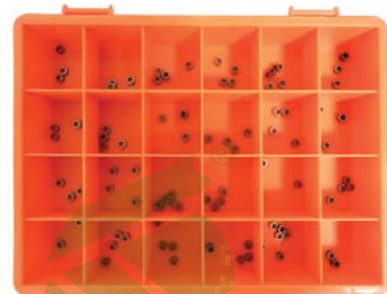

HANDBAG | VALIGETTA 24 POSIZIONI | POSITION

CODICE OMS	SPESSORE	INCREMENTO	N° PEZZI
11-23-376	DA 1,20 A 1,90	0,02	360



HANDBAG | VALIGETTA 36 POSIZIONI | POSITION

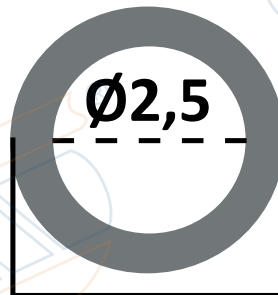
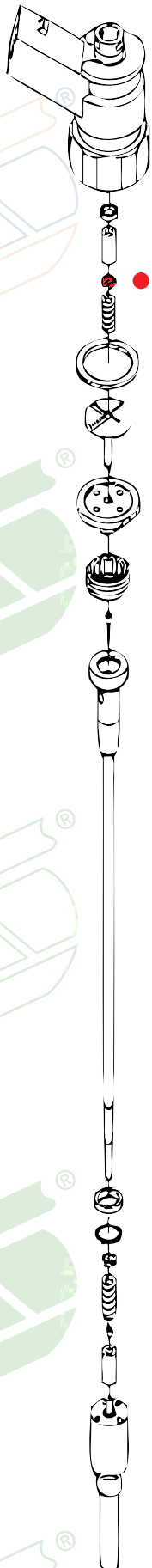

Ø4,5

TABELLA CODICI ORIGINALI
ORIGINAL CODES TABLE

MISURA	RIF. ORIGINALE	RIF. ORIGINALE NEW	COD. OMS	MISURA	RIF. ORIGINALE	RIF. ORIGINALE NEW	COD. OMS
0,90	-		11-23-230/090	1,52	F 00V C60 497	F 00Z C99 280	11-23-230/152
0,92	-		11-23-230/092	1,54	F 00V C60 499	F 00Z C99 281	11-23-230/154
0,94	-		11-23-230/094	1,55	-	-	11-23-230/155
0,95	-		11-23-230/095	1,56	F 00V C60 501	F 00Z C99 282	11-23-230/156
0,96	-		11-23-230/096	1,58	F 00V C60 503	F 00Z C99 283	11-23-230/158
0,98	-		11-23-230/098	1,60	F 00V C60 505	F 00Z C99 284	11-23-230/160
1,00	-		11-23-230/100	1,62	F 00V C60 507	F 00Z C99 285	11-23-230/162
1,02	-		11-23-230/102	1,64	F 00V C60 509	F 00Z C99 286	11-23-230/164
1,04	-		11-23-230/104	1,65	-	-	11-23-230/165
1,05	-		11-23-230/105	1,66	F 00V C60 511	F 00Z C99 287	11-23-230/166
1,06	-		11-23-230/106	1,68	F 00V C60 513	F 00Z C99 288	11-23-230/168
1,08	-		11-23-230/108	1,70	F 00V C60 515	F 00Z C99 289	11-23-230/170
1,10	-		11-23-230/110	1,72	F 00V C60 517	F 00Z C99 290	11-23-230/172
1,12	-		11-23-230/112	1,74	F 00V C60 519	F 00Z C99 291	11-23-230/174
1,14	-		11-23-230/114	1,75	-	-	11-23-230/175
1,15	-		11-23-230/115	1,76	F 00V C60 521	F 00Z C99 292	11-23-230/176
1,16	-		11-23-230/116	1,78	F 00V C60 523	F 00Z C99 293	11-23-230/178
1,18	-		11-23-230/118	1,80	F 00V C60 525	F 00Z C99 294	11-23-230/180
1,20	-		11-23-230/120	1,82	F 00V C60 527	F 00Z C99 295	11-23-230/182
1,22	-		11-23-230/122	1,84	F 00V C60 529	F 00Z C99 296	11-23-230/184
1,24	-		11-23-230/124	1,85	-	-	11-23-230/185
1,25	-		11-23-230/125	1,86	F 00V C60 531	F 00Z C99 297	11-23-230/186
1,26	-		11-23-230/126	1,88	F 00V C60 533	F 00Z C99 298	11-23-230/188
1,28	-		11-23-230/128	1,90	F 00V C60 535	F 00Z C99 299	11-23-230/190
1,30	-		11-23-230/130	1,92	-	-	11-23-230/192
1,32	-		11-23-230/132	1,94	-	-	11-23-230/194
1,34	-		11-23-230/134	1,95	-	-	11-23-230/195
1,35	-		11-23-230/135	1,96	-	-	11-23-230/196
1,36	-		11-23-230/136	1,98	-	-	11-23-230/198
1,38	-		11-23-230/138	2,00	-	-	11-23-230/200
1,40	F 00V C60 485	F 00Z C99 274	11-23-230/140	2,02	-	-	11-23-230/202
1,42	F 00V C60 487	F 00Z C99 275	11-23-230/142	2,04	-	-	11-23-230/204
1,44	F 00V C60 489	F 00Z C99 276	11-23-230/144	2,05	-	-	11-23-230/205
1,45	-	-	11-23-230/145	2,06	-	-	11-23-230/206
1,46	F 00V C60 491	F 00Z C99 277	11-23-230/146	2,08	-	-	11-23-230/208
1,48	F 00V C60 493	F 00Z C99 278	11-23-230/148	2,10	-	-	11-23-230/210
1,50	F 00V C60 495	F 00Z C99 279	11-23-230/150				



COMMON RAIL

BOSCH

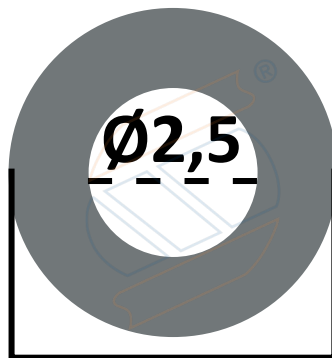
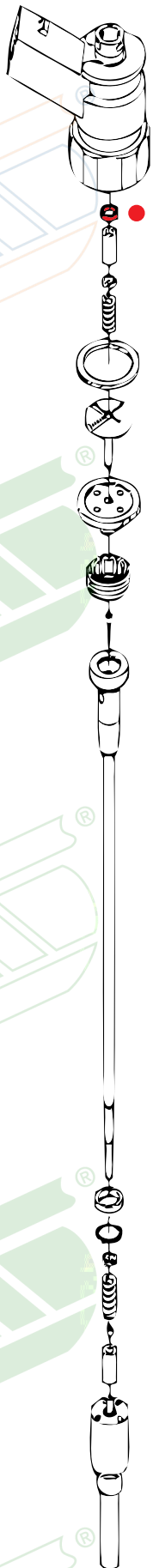

Ø6,4

CODICE OMS	SPESORE	INCREMENTO	N° PEZZI
11-23-329	DA 1,20 A 1,30	0,01	110



HANDBAG | VALIGETTA 12 POSIZIONI | POSITION

CODICE OMS	SPESORE	INCREMENTO	N° PEZZI
11-23-377	DA 1,00 A 1,40	0,01	410

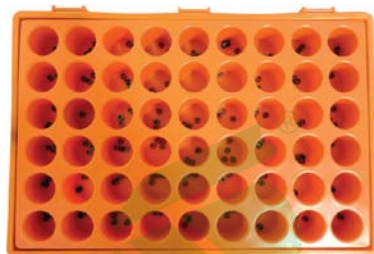

HANDBAG | VALIGETTA 54 POSIZIONI | POSITION

CODICE SINGOLI SPESSORI CODE INDIVIDUAL THICKNESSES

MISURA	COD. OMS
1,00	11-23-329/100
1,01	11-23-329/101
1,02	11-23-329/102
1,03	11-23-329/103
1,04	11-23-329/104
1,05	11-23-329/105
1,06	11-23-329/106
1,07	11-23-329/107
1,08	11-23-329/108
1,09	11-23-329/109
1,10	11-23-329/110
1,11	11-23-329/111
1,12	11-23-329/112
1,13	11-23-329/113
1,14	11-23-329/114
1,15	11-23-329/115
1,16	11-23-329/116
1,17	11-23-329/117
1,18	11-23-329/118
1,19	11-23-329/119
1,20	11-23-329/120
1,21	11-23-329/121
1,22	11-23-329/122
1,23	11-23-329/123
1,24	11-23-329/124
1,25	11-23-329/125
1,26	11-23-329/126
1,27	11-23-329/127
1,28	11-23-329/128
1,29	11-23-329/129
1,30	11-23-329/130
1,31	11-23-329/131
1,32	11-23-329/132
1,33	11-23-329/133
1,34	11-23-329/134
1,35	11-23-329/135
1,36	11-23-329/136
1,37	11-23-329/137
1,38	11-23-329/138
1,39	11-23-329/139
1,40	11-23-329/140



da 1,089... a 1,368

ALTRE MISURE DISPONIBILI A RICHIESTA
OTHER SIZES AVAILABLE UPON REQUEST
OTROS TAMAÑOS DISPONIBLES BAJO PETICIÓN
ДРУГИЕ РАЗМЕРЫ ДОСТУПНЫ ПО ЗАПРОСУ
根據要求提供其它尺寸

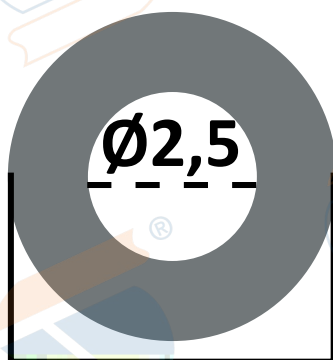
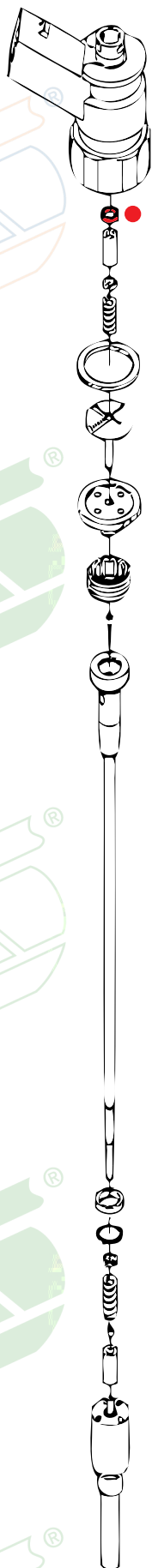

Ø6,4



HANDBAG | VALIGETTA 36 POSIZIONI | POSITION

TABELLA CODICI ORIGINALI
ORIGINAL CODES TABLE

MISURA	RIF. ORIGINALE	RIF. ORIG. NEW	COD. OMS
1,089	F 00V C60 386	F 00Z C99 179	11-23-329/1089
1,098	F 00V C60 389	F 00Z C99 180	11-23-329/1098
1,107	F 00V C60 392	F 00Z C99 181	11-23-329/1107
1,116	F 00V C60 395	F 00Z C99 182	11-23-329/1116
1,125	F 00V C60 398	F 00Z C99 183	11-23-329/1125
1,134	F 00V C60 401	F 00Z C99 184	11-23-329/1134
1,143	F 00V C60 404	F 00Z C99 185	11-23-329/1143
1,152	F 00V C60 407	F 00Z C99 186	11-23-329/1152
1,161	F 00V C60 410	F 00Z C99 187	11-23-329/1161
1,17	F 00V C60 413	F 00Z C99 188	11-23-329/1170
1,179	F 00V C60 416	F 00Z C99 189	11-23-329/1179
1,188	F 00V C60 419	F 00Z C99 190	11-23-329/1188
1,197	F 00V C60 422	F 00Z C99 191	11-23-329/1197
1,206	F 00V C60 425	F 00Z C99 192	11-23-329/1206
1,215	F 00V C60 428	F 00Z C99 193	11-23-329/1215
1,224	F 00V C60 431	F 00Z C99 194	11-23-329/1224
1,233	F 00V C60 434	F 00Z C99 195	11-23-329/1233
1,242	F 00V C60 437	F 00Z C99 196	11-23-329/1242
1,251	F 00V C60 440	F 00Z C99 197	11-23-329/1251
1,26	F 00V C60 443	F 00Z C99 198	11-23-329/1260
1,269	F 00V C60 446	F 00Z C99 199	11-23-329/1269
1,278	F 00V C60 449	F 00Z C99 200	11-23-329/1278
1,287	F 00V C60 452	F 00Z C99 201	11-23-329/1287
1,296	F 00V C60 455	F 00Z C99 202	11-23-329/1296
1,305	F 00V C60 458	F 00Z C99 203	11-23-329/1305
1,314	F 00V C60 461	F 00Z C99 204	11-23-329/1314
1,323	F 00V C60 464	F 00Z C99 205	11-23-329/1323
1,332	F 00V C60 467	F 00Z C99 206	11-23-329/1332
1,341	F 00V C60 470	F 00Z C99 207	11-23-329/1341
1,35	F 00V C60 473	F 00Z C99 208	11-23-329/1350
1,359	F 00V C60 476	F 00Z C99 209	11-23-329/1359
1,368	F 00V C60 479	F 00Z C99 210	11-23-329/1368

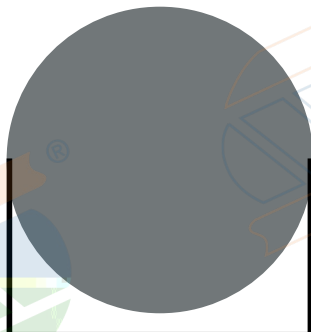
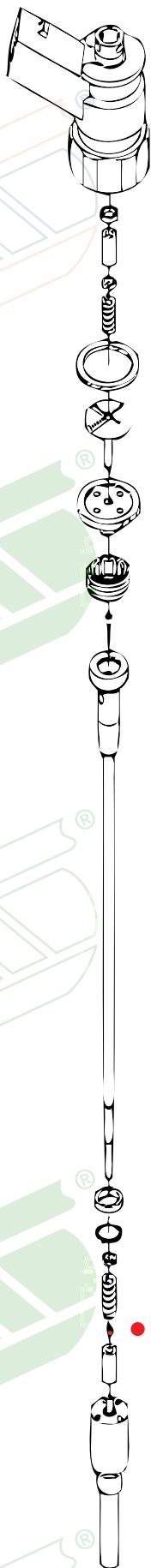

Ø2,3
PASTIGLIETTA
tablet
tableta

da 0,90... a 1,46
ALTRE MISURE DISPONIBILI A RICHIESTA
OTHER SIZES AVAILABLE UPON REQUEST
OTROS TAMAÑOS DISPONIBLES BAJO PETICIÓN
ДРУГИЕ РАЗМЕРЫ ДОСТУПНЫ ПО ЗАПРОСУ
根據要求提供其它尺寸

CODICE OMS	SPESORE	INCREMENTO	N° PEZZI
11-23-305	DA 0,90 A 1,01	0,01	120
11-23-306	DA 1,02 A 1,13	0,01	120
11-23-232	DA 1,14 A 1,25	0,01	120



HANDBAG | VALIGETTA **12** POSIZIONI | POSITION

CODICE OMS	SPESORE	INCREMENTO	N° PEZZI
11-23-283	DA 0,95 A 1,13	0,01	190



HANDBAG | VALIGETTA **24** POSIZIONI | POSITION

CODICE OMS	SPESORE	INCREMENTO	N° PEZZI
11-23-379	DA 1,00 A 1,36	0,01	370



HANDBAG | VALIGETTA **54** POSIZIONI | POSITION

TABELLA CODICI ORIGINALI
ORIGINAL CODES TABLE

MISURA	RIF. ORIGINALE	RIF. ORIG. NEW	COD. OMS
0,90	-	-	11-23-232/090
0,91	-	-	11-23-232/091
0,92	-	-	11-23-232/092
0,93	-	-	11-23-232/093
0,94	-	-	11-23-232/094
0,95	-	-	11-23-232/095
0,96	-	-	11-23-232/096
0,97	-	-	11-23-232/097
0,98	-	-	11-23-232/098
0,99	-	-	11-23-232/099
1,00	F 00V C12 500	F 00Z C99 108	11-23-232/100
1,01	F 00V C12 502	F 00Z C99 109	11-23-232/101
1,02	F 00V C12 504	F 00Z C99 110	11-23-232/102
1,03	F 00V C12 506	F 00Z C99 111	11-23-232/103
1,04	F 00V C12 508	F 00Z C99 112	11-23-232/104
1,05	F 00V C12 510	F 00Z C99 113	11-23-232/105
1,06	F 00V C12 512	F 00Z C99 114	11-23-232/106
1,07	F 00V C12 514	F 00Z C99 115	11-23-232/107
1,08	F 00V C12 516	F 00Z C99 116	11-23-232/108
1,09	F 00V C12 518	F 00Z C99 117	11-23-232/109
1,10	F 00V C12 520	F 00Z C99 118	11-23-232/110
1,11	F 00V C12 522	F 00Z C99 119	11-23-232/111
1,12	F 00V C12 524	F 00Z C99 120	11-23-232/112
1,13	F 00V C12 526	F 00Z C99 121	11-23-232/113
1,14	F 00V C12 528	F 00Z C99 122	11-23-232/114
1,15	F 00V C12 530	F 00Z C99 123	11-23-232/115
1,16	F 00V C12 532	F 00Z C99 124	11-23-232/116
1,17	F 00V C12 534	F 00Z C99 125	11-23-232/117
1,18	F 00V C12 536	F 00Z C99 126	11-23-232/118
1,19	F 00V C12 538	F 00Z C99 127	11-23-232/119
1,20	F 00V C12 540	F 00Z C99 128	11-23-232/120
1,21	F 00V C12 542	F 00Z C99 129	11-23-232/121
1,22	F 00V C12 544	F 00Z C99 130	11-23-232/122
1,23	F 00V C12 546	F 00Z C99 131	11-23-232/123
1,24	F 00V C12 548	F 00Z C99 132	11-23-232/124
1,25	F 00V C12 550	F 00Z C99 133	11-23-232/125
1,26	F 00V C12 552	F 00Z C99 134	11-23-232/126
1,27	F 00V C12 554	F 00Z C99 135	11-23-232/127
1,28	F 00V C12 556	F 00Z C99 136	11-23-232/128
1,29	F 00V C12 558	F 00Z C99 137	11-23-232/129
1,30	F 00V C12 560	F 00Z C99 138	11-23-232/130
1,31	F 00V C12 562	F 00Z C99 139	11-23-232/131
1,32	F 00V C12 564	F 00Z C99 140	11-23-232/132
1,33	F 00V C12 566	F 00Z C99 141	11-23-232/133
1,34	F 00V C12 568	F 00Z C99 142	11-23-232/134
1,35	F 00V C12 570	F 00Z C99 143	11-23-232/135
1,36	F 00V C12 572	F 00Z C99 144	11-23-232/136
1,37	-	-	11-23-232/137
1,38	-	-	11-23-232/138
1,39	-	-	11-23-232/139
1,40	-	-	11-23-232/140
1,41	-	-	11-23-232/141
1,42	-	-	11-23-232/142
1,43	-	-	11-23-232/143
1,44	-	-	11-23-232/144
1,45	-	-	11-23-232/145
1,46	-	-	11-23-232/146

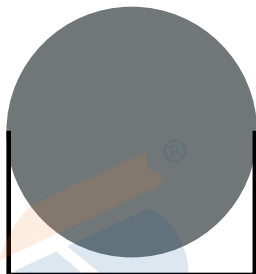
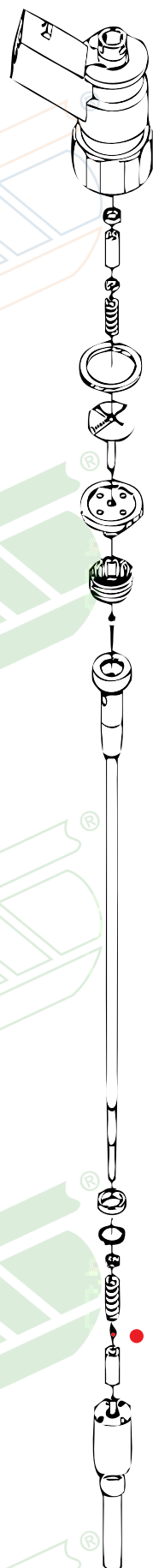
 $\varnothing 2,3$
PASTIGLIETTA
tablet
tableta



COMMON RAIL

BOSCH

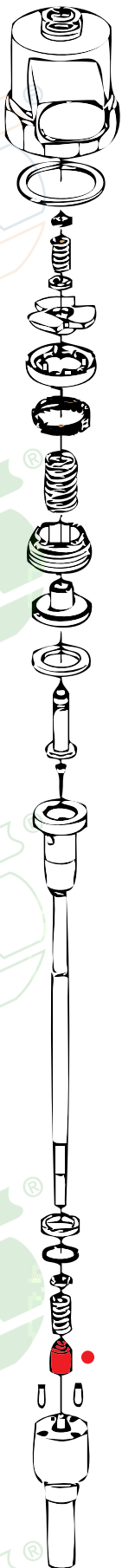

Ø 5,8

**VECCHIA VERSIONE
NEW VERSION**

**PERNO CILINDRICO
cylindrical pin
pasador cilíndrico**

da 8,25... a 8,70

ALTRE MISURE DISPONIBILI A RICHIESTA

OTHER SIZES AVAILABLE UPON REQUEST

OTROS TAMAÑOS DISPONIBLES BAJO PETICIÓN

ДРУГИЕ РАЗМЕРЫ ДОСТУПНЫ ПО ЗАПРОСУ

根據要求提供其它尺寸

CODICE OMS	SPESSORE	INCREMENTO	N° PEZZI
11-23-227	DA 8,40 A 8,50	0,01	110



HANDBAG | VALIGETTA 12 POSIZIONI | POSITION

CODICE OMS	SPESSORE	INCREMENTO	N° PEZZI
11-23-274	DA 8,50 A 8,70	0,01	210



HANDBAG | VALIGETTA 24 POSIZIONI | POSITION

CODICE OMS	SPESSORE	INCREMENTO	N° PEZZI
11-23-299	DA 8,40 A 8,70	0,01	310



HANDBAG | VALIGETTA 36 POSIZIONI | POSITION

CODICE SINGOLI SPESSORI CODE INDIVIDUAL THICKNESSES

MISURA	COD. OMS
8,25	11-23-227/825
8,26	11-23-227/826
8,27	11-23-227/827
8,28	11-23-227/828
8,29	11-23-227/829
8,30	11-23-227/830
8,31	11-23-227/831
8,32	11-23-227/832
8,33	11-23-227/833
8,34	11-23-227/834
8,35	11-23-227/835
8,36	11-23-227/836
8,37	11-23-227/837
8,38	11-23-227/838
8,39	11-23-227/839
8,40	11-23-227/840
8,41	11-23-227/841
8,42	11-23-227/842
8,43	11-23-227/843
8,44	11-23-227/844
8,45	11-23-227/845
8,46	11-23-227/846
8,47	11-23-227/847
8,48	11-23-227/848
8,49	11-23-227/849
8,50	11-23-227/850
8,51	11-23-227/851
8,52	11-23-227/852
8,53	11-23-227/853
8,54	11-23-227/854
8,55	11-23-227/855
8,56	11-23-227/856
8,57	11-23-227/857
8,58	11-23-227/858
8,59	11-23-227/859
8,60	11-23-227/860
8,61	11-23-227/861
8,62	11-23-227/862
8,63	11-23-227/863
8,64	11-23-227/864
8,65	11-23-227/865
8,66	11-23-227/866
8,67	11-23-227/867
8,68	11-23-227/868
8,69	11-23-227/869
8,70	11-23-227/870

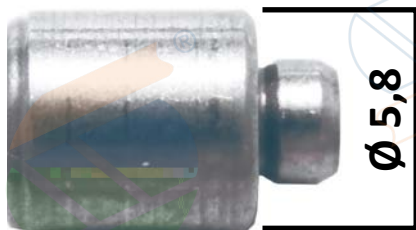
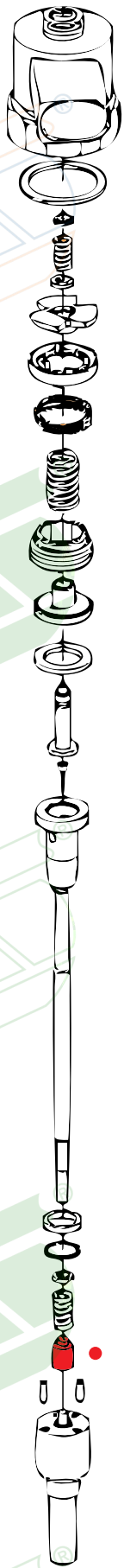

Ø 5,8

**VECCHIA VERSIONE
NEW VERSION**

**PERNO CILINDRICO
cylindrical pin
pasador cilíndrico**

da 8,277... a 8,571

ALTRE MISURE DISPONIBILI A RICHIESTA
OTHER SIZES AVAILABLE UPON REQUEST
OTROS TAMAÑOS DISPONIBLES BAJO PETICIÓN
ДРУГИЕ РАЗМЕРЫ ДОСТУПНЫ ПО ЗАПРОСУ

CODICE OMS	SPESSORE	INCREMENTO	N° PEZZI
11-23-380	DA 8,277 A 8,571	0,012	260



HANDBAG | VALIGETTA 36 POSIZIONI | POSITION

**CODICE SINGOLI SPESSORI
CODE INDIVIDUAL THICKNESSES**

MISURA	COD. OMS
8,277	11-23-227/8277
8,289	11-23-227/8289
8,301	11-23-227/8301
8,313	11-23-227/8313
8,325	11-23-227/8325
8,337	11-23-227/8337
8,349	11-23-227/8349
8,361	11-23-227/8361
8,373	11-23-227/8373
8,385	11-23-227/8385
8,397	11-23-227/8397
8,409	11-23-227/8409
8,421	11-23-227/8421
8,433	11-23-227/8433
8,445	11-23-227/8445
8,457	11-23-227/8457
8,469	11-23-227/8469
8,481	11-23-227/8481
8,493	11-23-227/8493
8,505	11-23-227/8505
8,517	11-23-227/8517
8,529	11-23-227/8529
8,541	11-23-227/8541
8,553	11-23-227/8553
8,565	11-23-227/8565
8,571	11-23-227/8571



COMMON RAIL

BOSCH

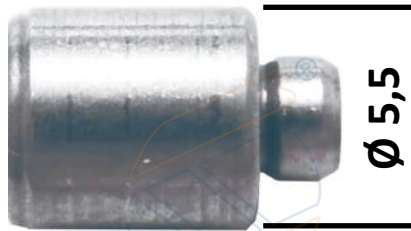
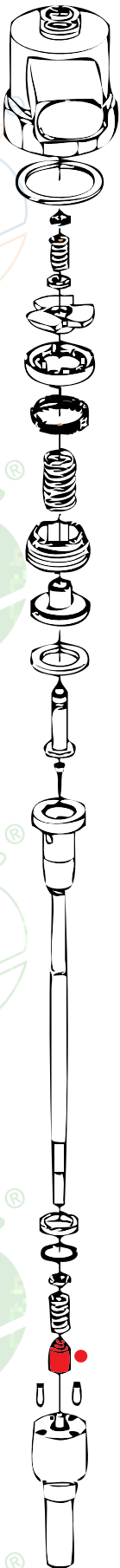

NUOVA VERSIONE NEW VERSION

PERNO CILINDRICO
cylindrical pin
pasador cilíndrico

da 8,20... a 8,70

ALTRE MISURE DISPONIBILI A RICHIESTA

OTHER SIZES AVAILABLE UPON REQUEST

OTROS TAMAÑOS DISPONIBLES BAJO PETICIÓN

ДРУГИЕ РАЗМЕРЫ ДОСТУПНЫ ПО ЗАПРОСУ

根據要求提供其它尺寸

CODICE OMS	SPESSORE	INCREMENTO	N° PEZZI
11-23-725	da 8,40 a 8,70	0,01	310



HANDBAG | VALIGETTA 36 POSIZIONI | POSITION

CODICE OMS	SPESSORE	INCREMENTO	N° PEZZI
11-23-723	da 8,20 a 8,70	0,01	510



HANDBAG | VALIGETTA 54 POSIZIONI | POSITION

CODICE SINGOLI SPESSORI CODE INDIVIDUAL THICKNESSES

MISURA	COD. OMS
8,20	11-23-723/820
8,21	11-23-723/821
8,22	11-23-723/822
8,23	11-23-723/823
8,24	11-23-723/824
8,25	11-23-723/825
8,26	11-23-723/826
8,27	11-23-723/827
8,28	11-23-723/828
8,29	11-23-723/829
8,30	11-23-723/830
8,31	11-23-723/831
8,32	11-23-723/832
8,33	11-23-723/833
8,34	11-23-723/834
8,35	11-23-723/835
8,36	11-23-723/836
8,37	11-23-723/837
8,38	11-23-723/838
8,39	11-23-723/839
8,40	11-23-723/840
8,41	11-23-723/841
8,42	11-23-723/842
8,43	11-23-723/843
8,45	11-23-723/845
8,46	11-23-723/846
8,47	11-23-723/847
8,48	11-23-723/848
8,49	11-23-723/849
8,50	11-23-723/850
8,51	11-23-723/851
8,52	11-23-723/852
8,53	11-23-723/853
8,54	11-23-723/854
8,55	11-23-723/855
8,56	11-23-723/856
8,57	11-23-723/857
8,58	11-23-723/858
8,59	11-23-723/859
8,60	11-23-723/860
8,61	11-23-723/861
8,62	11-23-723/862
8,63	11-23-723/863
8,64	11-23-723/864
8,65	11-23-723/865
8,66	11-23-723/866
8,67	11-23-723/867
8,68	11-23-723/868
8,69	11-23-723/869
8,70	11-23-723/870



BOSCH

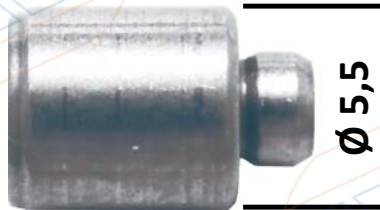
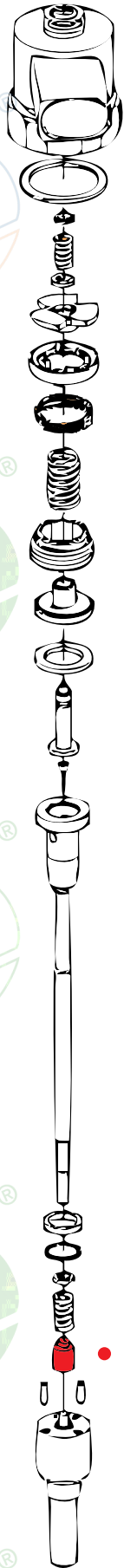

**NUOVA VERSIONE
NEW VERSION**

**PERNO CILINDRICO
cylindrical pin
pasador cilíndrico**

CODICE OMS	SPESSORE	INCREMENTO	N° PEZZI
11-23-726	DA 8,277 A 8,697	0,012	360



HANDBAG | VALIGETTA 36 POSIZIONI | POSITION

**TABELLA CODICI ORIGINALI
ORIGINAL CODES TABLE**

MISURA	RIF. ORIGINALE	RIF. ORIG. NEW	COD. OMS
8,277	F 00V C12 400	F 00Z C99 145	11-23-723/8277
8,289	F 00V C12 404	F 00Z C99 146	11-23-723/8289
8,301	F 00V C12 408	F 00Z C99 147	11-23-723/8301
8,313	F 00V C12 412	F 00Z C99 148	11-23-723/8313
8,325	F 00V C12 416	F 00Z C99 149	11-23-723/8325
8,337	F 00V C12 420	F 00Z C99 150	11-23-723/8337
8,349	F 00V C12 424	F 00Z C99 151	11-23-723/8349
8,361	F 00V C12 428	F 00Z C99 152	11-23-723/8361
8,373	F 00V C12 432	F 00Z C99 153	11-23-723/8373
8,385	F 00V C12 436	F 00Z C99 154	11-23-723/8385
8,397	F 00V C12 440	F 00Z C99 155	11-23-723/8397
8,409	F 00V C12 444	F 00Z C99 156	11-23-723/8409
8,421	F 00V C12 448	F 00Z C99 157	11-23-723/8421
8,433	F 00V C12 452	F 00Z C99 158	11-23-723/8433
8,445	F 00V C12 456	F 00Z C99 159	11-23-723/8445
8,457	F 00V C12 460	F 00Z C99 160	11-23-723/8457
8,469	F 00V C12 464	F 00Z C99 161	11-23-723/8469
8,481	F 00V C12 468	F 00Z C99 162	11-23-723/8481
8,493	F 00V C12 472	F 00Z C99 163	11-23-723/8493
8,505	F 00V C12 476	F 00Z C99 164	11-23-723/8505
8,517	F 00V C12 480	F 00Z C99 165	11-23-723/8517
8,529	F 00V C12 484	F 00Z C99 166	11-23-723/8529
8,541	F 00V C12 488	F 00Z C99 167	11-23-723/8541
8,553	F 00V C12 492	F 00Z C99 168	11-23-723/8553
8,565	F 00V C12 496	F 00Z C99 169	11-23-723/8565
8,577	-	-	11-23-723/8577
8,589	-	-	11-23-723/8589
8,601	-	-	11-23-723/8601
8,613	-	-	11-23-723/8613
8,625	-	-	11-23-723/8625
8,637	-	-	11-23-723/8637
8,649	-	-	11-23-723/8649
8,661	-	-	11-23-723/8661
8,673	-	-	11-23-723/8673
8,685	-	-	11-23-723/8685
8,697	-	-	11-23-723/8697



COMMON RAIL

BOSCH

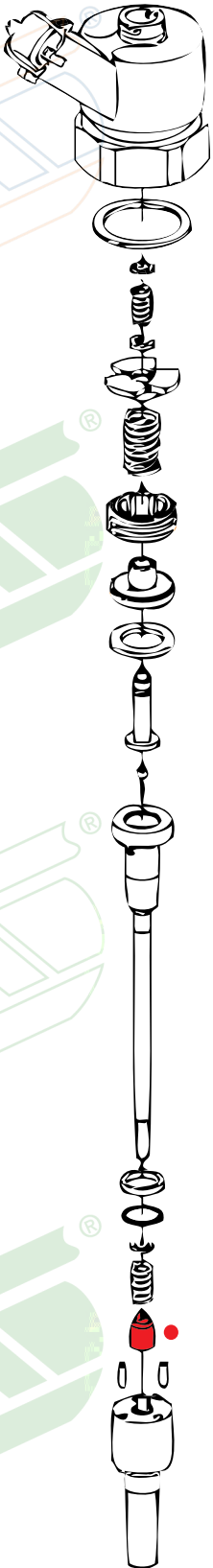

PERNO FRESATO
pin milled
pin molido

da 8,30... a 8,70
ALTRE MISURE DISPONIBILI A RICHIESTA
OTHER SIZES AVAILABLE UPON REQUEST
OTROS TAMAÑOS DISPONIBLES BAJO PETICIÓN
ДРУГИЕ РАЗМЕРЫ ДОСТУПНЫ ПО ЗАПРОСУ

CODICE OMS	SPESSORE	INCREMENTO	N° PEZZI
11-23-104	DA 8,40 A 8,50	0,01	110



HANDBAG | VALIGETTA 12 POSIZIONI | POSITION

CODICE OMS	SPESSORE	INCREMENTO	N° PEZZI
11-23-275	DA 8,50 A 8,70	0,01	210



HANDBAG | VALIGETTA 24 POSIZIONI | POSITION

CODICE OMS	SPESSORE	INCREMENTO	N° PEZZI
11-23-298	DA 8,40 A 8,70	0,01	310



HANDBAG | VALIGETTA 36 POSIZIONI | POSITION

CODICE SINGOLI SPESSORI CODE INDIVIDUAL THICKNESSES	
MISURA	COD. OMS
8,30	11-23-104/830
8,31	11-23-104/831
8,32	11-23-104/832
8,33	11-23-104/833
8,34	11-23-104/834
8,35	11-23-104/835
8,36	11-23-104/836
8,37	11-23-104/837
8,38	11-23-104/838
8,39	11-23-104/839
8,40	11-23-104/840
8,41	11-23-104/841
8,42	11-23-104/842
8,43	11-23-104/843
8,44	11-23-104/844
8,45	11-23-104/845
8,46	11-23-104/846
8,47	11-23-104/847
8,48	11-23-104/848
8,49	11-23-104/849
8,50	11-23-104/850
8,51	11-23-104/851
8,52	11-23-104/852
8,53	11-23-104/853
8,54	11-23-104/854
8,55	11-23-104/855
8,56	11-23-104/856
8,57	11-23-104/857
8,58	11-23-104/858
8,59	11-23-104/859
8,60	11-23-104/860
8,61	11-23-104/861
8,62	11-23-104/862
8,63	11-23-104/863
8,64	11-23-104/864
8,65	11-23-104/865
8,66	11-23-104/866
8,67	11-23-104/867
8,68	11-23-104/868
8,69	11-23-104/869
8,70	11-23-104/870

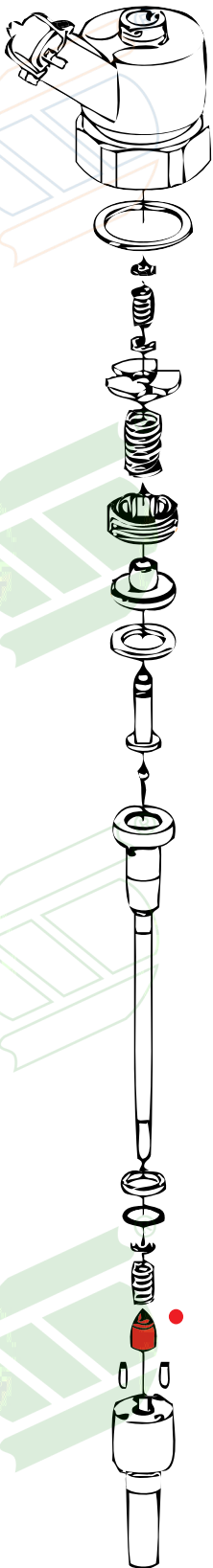

PERNO FRESATO
pin milled
pin molido

da 8,277... a 8,571

ALTRE MISURE DISPONIBILI A RICHIESTA

OTHER SIZES AVAILABLE UPON REQUEST

OTROS TAMAÑOS DISPONIBLES BAJO PETICIÓN

ДРУГИЕ РАЗМЕРЫ ДОСТУПНЫ ПО ЗАПРОСУ

根據要求提供其它尺寸



TABELLA CODICI ORIGINALI
ORIGINAL CODES TABLE

MISURA	RIF. ORIGINALE	COD. OMS
8,277	F 00V C12 300	11-23-104/8277
8,289	F 00V C12 304	11-23-104/8289
8,301	F 00V C12 308	11-23-104/8301
8,313	F 00V C12 312	11-23-104/8313
8,325	F 00V C12 316	11-23-104/8325
8,337	F 00V C12 320	11-23-104/8337
8,349	F 00V C12 324	11-23-104/8349
8,361	F 00V C12 328	11-23-104/8361
8,373	F 00V C12 332	11-23-104/8373
8,385	F 00V C12 336	11-23-104/8385
8,397	F 00V C12 340	11-23-104/8397
8,409	F 00V C12 344	11-23-104/8409
8,421	F 00V C12 348	11-23-104/8421
8,433	F 00V C12 352	11-23-104/8433
8,445	F 00V C12 356	11-23-104/8445
8,457	F 00V C12 360	11-23-104/8457
8,469	F 00V C12 364	11-23-104/8469
8,481	F 00V C12 368	11-23-104/8481
8,493	F 00V C12 372	11-23-104/8493
8,505	F 00V C12 376	11-23-104/8505
8,517	F 00V C12 380	11-23-104/8517
8,529	F 00V C12 384	11-23-104/8529
8,541	F 00V C12 388	11-23-104/8541
8,553	F 00V C12 392	11-23-104/8553
8,565	F 00V C12 396	11-23-104/8565
8,571	F 00V C12 398	11-23-104/ 8571



COMMON RAIL

BOSCH

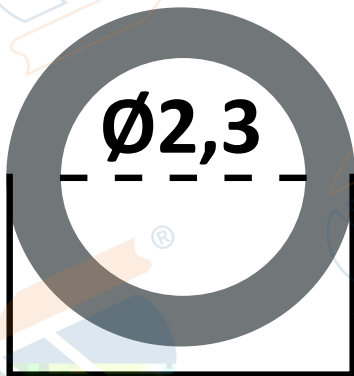
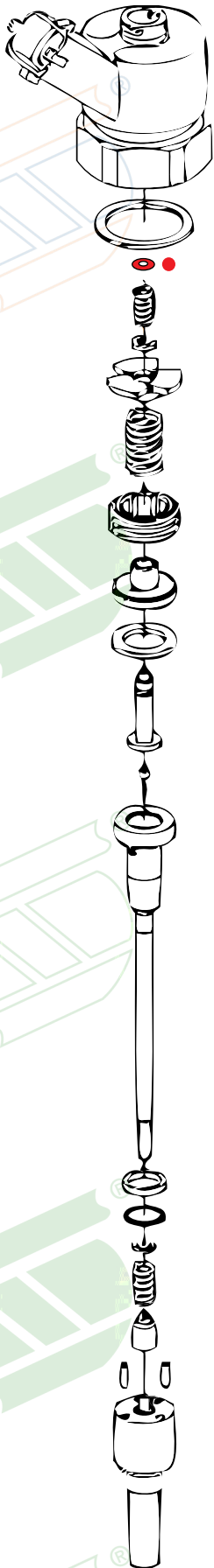

Ø4

da 0,80... a 2,30
 ALTRE MISURE DISPONIBILI A RICHIESTA
 OTHER SIZES AVAILABLE UPON REQUEST
 OTROS TAMAÑOS DISPONIBLES BAJO PETICIÓN
 ДРУГИЕ РАЗМЕРЫ ДОСТУПНЫ ПО ЗАПРОСУ
 根據要求提供其它尺寸

CODICE OMS	SPESORE	INCREMENTO	N° PEZZI
11-23-276	DA 1,72 A 1,90	0,02	110

HANDBAG | VALIGETTA 12 POSIZIONI | POSITION

CODICE OMS	SPESORE	INCREMENTO	N° PEZZI
11-23-229	DA 1,20 A 1,70	0,02	240
11-23-733	DA 1,15 A 2,30	0,05	240

HANDBAG | VALIGETTA 24 POSIZIONI | POSITION

CODICE OMS	SPESORE	INCREMENTO	N° PEZZI
11-23-417	DA 1,20 A 1,90	0,02	360

HANDBAG | VALIGETTA 36 POSIZIONI | POSITION

CODICE SINGOLI SPESSORI CODE INDIVIDUAL THICKNESSES			
MISURA	COD. OMS	MISURA	COD. OMS
0,80	11-23-229/080	1,44	11-23-229/144
0,82	11-23-229/082	1,45	11-23-229/145
0,84	11-23-229/084	1,46	11-23-229/146
0,85	11-23-229/085	1,48	11-23-229/148
0,86	11-23-229/086	1,50	11-23-229/150
0,88	11-23-229/088	1,52	11-23-229/152
0,90	11-23-229/090	1,54	11-23-229/154
0,92	11-23-229/092	1,55	11-23-229/155
0,94	11-23-229/094	1,56	11-23-229/156
0,95	11-23-229/095	1,58	11-23-229/158
0,96	11-23-229/096	1,60	11-23-229/160
0,98	11-23-229/098	1,62	11-23-229/162
1,00	11-23-229/100	1,64	11-23-229/164
1,02	11-23-229/102	1,65	11-23-229/165
1,04	11-23-229/104	1,66	11-23-229/166
1,05	11-23-229/105	1,68	11-23-229/168
1,06	11-23-229/106	1,70	11-23-229/170
1,08	11-23-229/108	1,72	11-23-229/172
1,10	11-23-229/110	1,74	11-23-229/174
1,12	11-23-229/112	1,75	11-23-229/175
1,14	11-23-229/114	1,76	11-23-229/176
1,15	11-23-229/115	1,78	11-23-229/178
1,16	11-23-229/116	1,80	11-23-229/180
1,18	11-23-229/118	1,82	11-23-229/182
1,20	11-23-229/120	1,84	11-23-229/184
1,22	11-23-229/122	1,85	11-23-229/185
1,24	11-23-229/124	1,86	11-23-229/186
1,25	11-23-229/125	1,88	11-23-229/188
1,26	11-23-229/126	1,90	11-23-229/190
1,28	11-23-229/128	1,95	11-23-229/195
1,30	11-23-229/130	2,00	11-23-229/200
1,32	11-23-229/132	2,05	11-23-229/205
1,34	11-23-229/134	2,10	11-23-229/210
1,35	11-23-229/135	2,15	11-23-229/215
1,36	11-23-229/136	2,20	11-23-229/220
1,38	11-23-229/138	2,25	11-23-229/225
1,40	11-23-229/140	2,30	11-23-229/230
1,42	11-23-229/142		

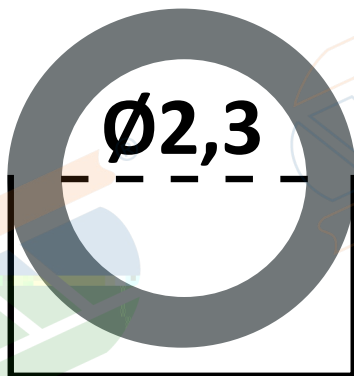
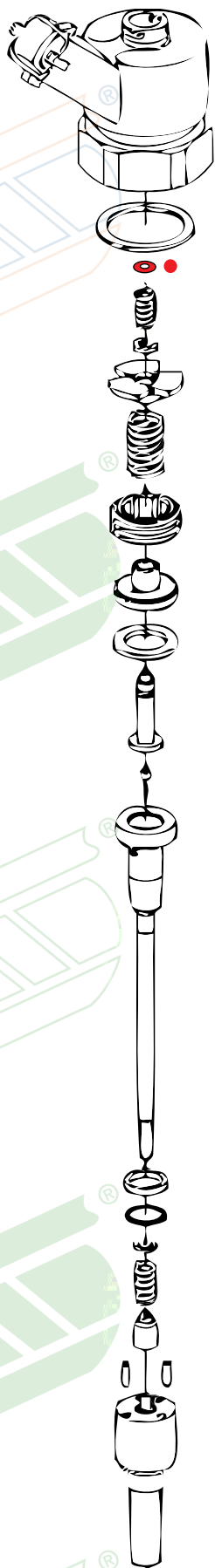

Ø4

da 0,94... a 1,60

ALTRE MISURE DISPONIBILI A RICHIESTA
OTHER SIZES AVAILABLE UPON REQUEST
OTROS TAMAÑOS DISPONIBLES BAJO PETICIÓN
ДРУГИЕ РАЗМЕРЫ ДОСТУПНЫ ПО ЗАПРОСУ
根據要求提供其它尺寸

CODICE OMS	SPESORE	INCREMENTO	N° PEZZI
11-23-953	DA 0,94 A 1,60	0,03	230

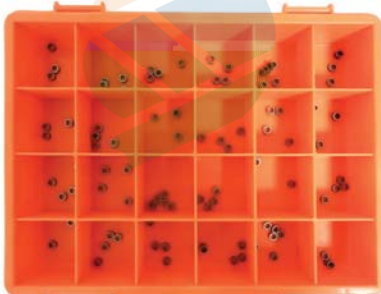

HANDBAG | VALIGETTA 24 POSIZIONI | POSITION

TABELLA CODICI ORIGINALI
ORIGINAL CODES TABLE

MISURA	RIF. ORIGINALE	RIF. ORIGINALE 2	COD. OMS
0,94	F 00R J00 772	-	11-23-954/094
0,97	F 00R J00 775	F 00R J04 648	11-23-954/097
1,00	F 00R J00 778	F 00R J04 649	11-23-954/100
1,03	F 00R J00 781	F 00R J04 650	11-23-954/103
1,06	F 00R J00 784	F 00R J04 651	11-23-954/106
1,09	F 00R J00 787	F 00R J04 652	11-23-954/109
1,12	F 00R J00 790	F 00R J04 653	11-23-954/112
1,15	F 00R J00 793	F 00R J04 654	11-23-954/115
1,18	F 00R J00 796	F 00R J04 655	11-23-954/118
1,21	F 00R J00 799	F 00R J04 656	11-23-954/121
1,24	F 00R J00 802	F 00R J04 657	11-23-954/124
1,27	F 00R J00 805	F 00R J04 658	11-23-954/127
1,30	F 00R J00 808	F 00R J04 659	11-23-954/130
1,33	F 00R J00 811	F 00R J04 660	11-23-954/133
1,36	F 00R J00 814	F 00R J04 661	11-23-954/136
1,39	F 00R J00 817	F 00R J04 662	11-23-954/139
1,42	F 00R J00 820	F 00R J04 663	11-23-954/142
1,45	F 00R J00 823	F 00R J04 664	11-23-954/145
1,48	F 00R J00 834	-	11-23-954/148
1,51	-	-	11-23-954/151
1,54	-	-	11-23-954/154
1,57	-	-	11-23-954/157
1,60	-	-	11-23-954/160



COMMON RAIL

BOSCH

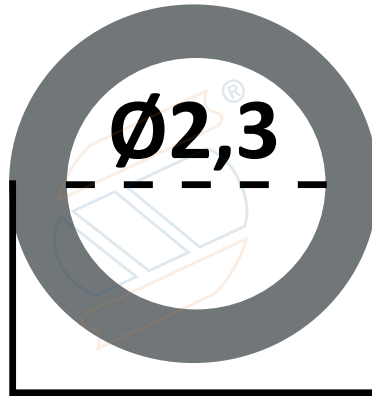
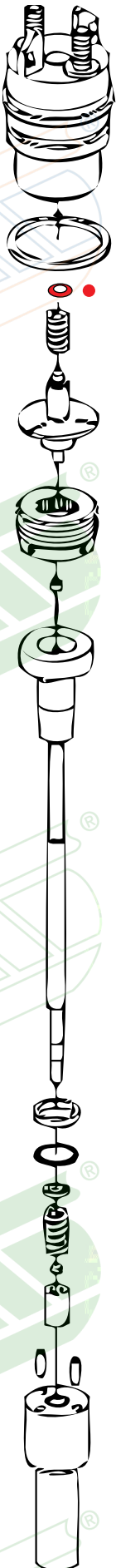

Ø4,2

da 0,60... a 2,30

ALTRE MISURE DISPONIBILI A RICHIESTA

OTHER SIZES AVAILABLE UPON REQUEST

OTROS TAMAÑOS DISPONIBLES BAJO PETICIÓN

ДРУГИЕ РАЗМЕРЫ ДОСТУПНЫ ПО ЗАПРОСУ

根據要求提供其它尺寸

CODICE OMS	SPESSORE	INCREMENTO	N° PEZZI
11-23-243	DA 1,20 A 1,70	0,05	110
11-23-228/1	DA 0,60 A 0,80	0,02	110



HANDBAG|VALIGETTA 12 POSIZIONI|POSITION

CODICE OMS	SPESSORE	INCREMENTO	N° PEZZI
11-23-228	DA 1,20 A 1,70	0,02	240
11-23-270	DA 1,70 A 1,96	0,02	140
11-23-734	DA 1,15 A 2,30	0,05	240

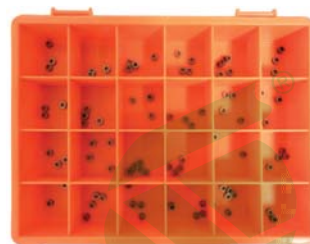

HANDBAG|VALIGETTA 24 POSIZIONI|POSITION

CODICE OMS	SPESSORE	INCREMENTO	N° PEZZI
11-23-398	DA 1,20 A 1,96	0,02	390
11-23-382	DA 0,80 A 1,64	0,02	430

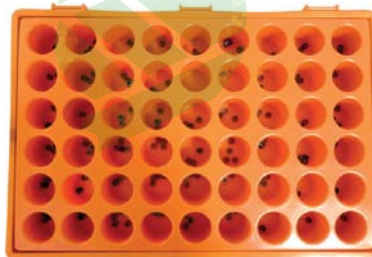

HANDBAG|VALIGETTA 54 POSIZIONI|POSITION



BOSCH

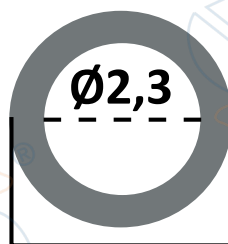
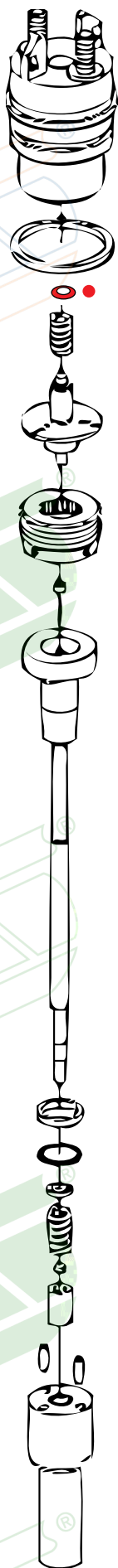

Ø4,2

TABELLA CODICI ORIGINALI
ORIGINAL CODES TABLE

MISURA	RIF. ORIGINALE	COD. OMS	MISURA	RIF. ORIGINALE	COD. OMS
0,60	-	11-23-228/060	1,46	F OOR J00 283	11-23-228/146
0,62	-	11-23-228/062	1,48	F OOR J00 203	11-23-228/148
0,64	-	11-23-228/064	1,50	F OOR J00 284	11-23-228/150
0,65	-	11-23-228/065	1,52	F OOR J00 204	11-23-228/152
0,66	-	11-23-228/066	1,54	F OOR J00 285	11-23-228/154
0,68	-	11-23-228/068	1,55	-	11-23-228/155
0,70	-	11-23-228/070	1,56	F OOR J00 205	11-23-228/156
0,72	-	11-23-228/072	1,58	F OOR J00 286	11-23-228/158
0,74	-	11-23-228/074	1,60	F OOR J00 206	11-23-228/160
0,75	-	11-23-228/075	1,62	F OOR J00 287	11-23-228/162
0,76	-	11-23-228/076	1,64	F OOR J00 207	11-23-228/164
0,78	-	11-23-228/078	1,65	-	11-23-228/165
0,80	F OOR J00 481	11-23-228/080	1,66	-	11-23-228/166
0,82	F OOR J00 482	11-23-228/082	1,68	-	11-23-228/168
0,84	F OOR J00 483	11-23-228/084	1,70	-	11-23-228/170
0,85	-	11-23-228/085	1,72	-	11-23-228/172
0,86	F OOR J00 484	11-23-228/086	1,74	-	11-23-228/174
0,88	F OOR J00 485	11-23-228/088	1,75	-	11-23-228/175
0,90	F OOR J00 486	11-23-228/090	1,76	-	11-23-228/176
0,92	F OOR J00 189	11-23-228/092	1,78	-	11-23-228/178
0,94	F OOR J00 207	11-23-228/094	1,80	-	11-23-228/180
0,95	-	11-23-228/095	1,82	-	11-23-228/182
0,96	F OOR J00 190	11-23-228/096	1,84	-	11-23-228/184
0,98	F OOR J00 271	11-23-228/098	1,85	-	11-23-228/185
1,00	F OOR J00 191	11-23-228/100	1,86	-	11-23-228/186
1,02	F OOR J00 272	11-23-228/102	1,88	-	11-23-228/188
1,04	F OOR J00 192	11-23-228/104	1,90	-	11-23-228/190
1,05	-	11-23-228/105	1,92	-	11-23-228/192
1,06	F OOR J00 273	11-23-228/106	1,94	-	11-23-228/194
1,08	F OOR J00 193	11-23-228/108	1,95	-	11-23-228/195
1,10	F OOR J00 274	11-23-228/110	1,96	-	11-23-228/196
1,12	F OOR J00 194	11-23-228/112	1,98	-	11-23-228/198
1,14	F OOR J00 275	11-23-228/114	2,00	-	11-23-228/200
1,15	-	11-23-228/115	2,02	-	11-23-228/202
1,16	F OOR J00 195	11-23-228/116	2,04	-	11-23-228/204
1,18	F OOR J00 276	11-23-228/118	2,05	-	11-23-228/205
1,20	F OOR J00 196	11-23-228/120	2,06	-	11-23-228/206
1,22	F OOR J00 277	11-23-228/122	2,08	-	11-23-228/208
1,24	F OOR J00 197	11-23-228/124	2,10	-	11-23-228/210
1,25	-	11-23-228/125	2,12	-	11-23-228/212
1,26	F OOR J00 278	11-23-228/126	2,14	-	11-23-228/214
1,28	F OOR J00 198	11-23-228/128	2,15	-	11-23-228/215
1,30	F OOR J00 279	11-23-228/130	2,16	-	11-23-228/216
1,32	F OOR J00 199	11-23-228/132	2,18	-	11-23-228/218
1,34	F OOR J00 280	11-23-228/134	2,20	-	11-23-228/220
1,35	-	11-23-228/135	2,22	-	11-23-228/222
1,36	F OOR J00 200	11-23-228/136	2,24	-	11-23-228/224
1,38	F OOR J00 281	11-23-228/138	2,25	-	11-23-228/225
1,40	F OOR J00 201	11-23-228/140	2,26	-	11-23-228/226
1,42	F OOR J00 282	11-23-228/142	2,28	-	11-23-228/228
1,44	F OOR J00 202	11-23-228/144	2,30	-	11-23-228/230
1,45	-	11-23-228/145			



COMMON RAIL

BOSCH

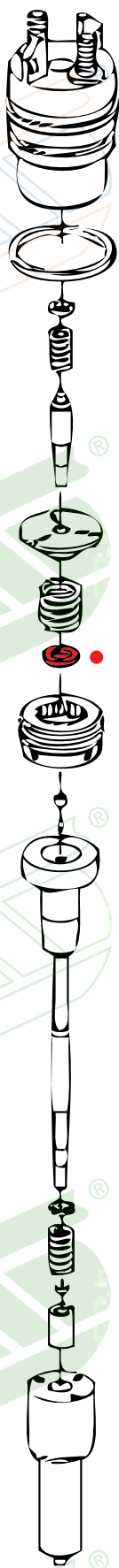

Ø7,7

da 0,98.. a 1,70

ALTRE MISURE DISPONIBILI A RICHIESTA

OTHER SIZES AVAILABLE UPON REQUEST

OTROS TAMAÑOS DISPONIBLES BAJO PETICIÓN

ДРУГИЕ РАЗМЕРЫ ДОСТУПНЫ ПО ЗАПРОСУ

根據要求提供其它尺寸

CODICE OMS	SPESORE	INCREMENTO	N° PEZZI
11-23-332	DA 0,98 A 1,44	0,02	240



HANDBAG | VALIGETTA 24 POSIZIONI | POSITION

CODICE SINGOLI SPESSORI CODE INDIVIDUAL THICKNESSES

MISURA	COD. OMS
0,98	11-23-332/098
1,00	11-23-332/100
1,02	11-23-332/102
1,04	11-23-332/104
1,05	11-23-332/105
1,06	11-23-332/106
1,08	11-23-332/108
1,10	11-23-332/110
1,12	11-23-332/112
1,14	11-23-332/114
1,15	11-23-332/115
1,16	11-23-332/116
1,18	11-23-332/118
1,20	11-23-332/120
1,22	11-23-332/122
1,24	11-23-332/124
1,25	11-23-332/125
1,26	11-23-332/126
1,28	11-23-332/128
1,30	11-23-332/130
1,32	11-23-332/132
1,34	11-23-332/134
1,35	11-23-332/135
1,36	11-23-332/136
1,38	11-23-332/138
1,40	11-23-332/140
1,42	11-23-332/142
1,44	11-23-332/144
1,45	11-23-332/145
1,50	11-23-332/150
1,55	11-23-332/155
1,60	11-23-332/160
1,65	11-23-332/165
1,70	11-23-332/170



TABELLA CODICI ORIGINALI ORIGINAL CODES TABLE

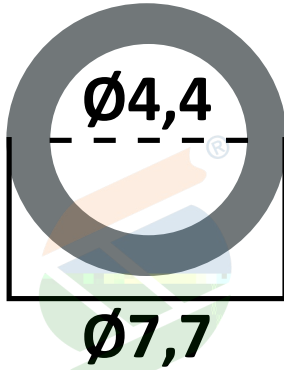

da 0,825.. a 1,385
 ALTRE MISURE DISPONIBILI A RICHIESTA
 OTHER SIZES AVAILABLE UPON REQUEST
 OTROS TAMAÑOS DISPONIBLES BAJO PETICIÓN
 ДРУГИЕ РАЗМЕРЫ ДОСТУПНЫ ПО ЗАПРОСУ
 根據要求提供其它尺寸

CODICE OMS	SPESSORE	INCREMENTO	N° PEZZI
11-23-383	DA 0,985 A 1,385	0,01	410

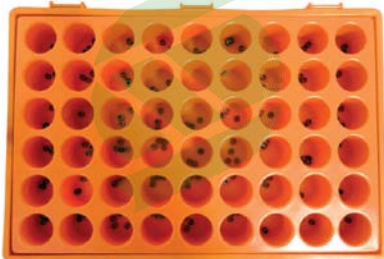

HANDBAG | VALIGETTA 54 POSIZIONI | POSITION

MISURA	RIF. ORIG.	RIF. ORIG. 2	RIF. ORIG. 3	COD. OMS
0,825	-	-	-	11-23-332/0825
0,835	-	-	-	11-23-332/0835
0,845	-	-	-	11-23-332/0845
0,855	-	-	-	11-23-332/0855
0,865	-	-	-	11-23-332/0865
0,875	-	-	-	11-23-332/0875
0,885	-	-	-	11-23-332/0885
0,895	-	-	-	11-23-332/0895
0,905	-	-	-	11-23-332/0905
0,915	-	-	-	11-23-332/0915
0,925	-	-	-	11-23-332/0925
0,935	-	-	-	11-23-332/0935
0,945	-	-	-	11-23-332/0945
0,955	-	-	-	11-23-332/0955
0,965	-	-	-	11-23-332/0965
0,975	-	-	-	11-23-332/0975
0,985	F 00R J01 008	-	-	11-23-332/0985
0,995	F 00R J01 009	F 00R J04 715	F 00R J04 226	11-23-332/0995
1,005	F 00R J01 010	F 00R J04 716	F 00R J04 227	11-23-332/1005
1,015	F 00R J01 011	F 00R J04 717	F 00R J04 228	11-23-332/1015
1,025	F 00R J01 012	F 00R J04 718	F 00R J04 229	11-23-332/1025
1,035	F 00R J01 013	F 00R J04 719	F 00R J04 230	11-23-332/1035
1,045	F 00R J01 014	F 00R J04 720	F 00R J04 231	11-23-332/1045
1,055	F 00R J01 015	F 00R J04 721	F 00R J04 232	11-23-332/1055
1,065	F 00R J01 016	F 00R J04 722	F 00R J04 233	11-23-332/1065
1,075	F 00R J01 017	F 00R J04 723	F 00R J04 234	11-23-332/1075
1,085	F 00R J01 018	F 00R J04 724	F 00R J04 235	11-23-332/1085
1,095	F 00R J01 019	F 00R J04 725	F 00R J04 236	11-23-332/1095
1,105	F 00R J01 020	F 00R J04 726	F 00R J04 237	11-23-332/1105
1,115	F 00R J01 021	F 00R J04 727	F 00R J04 238	11-23-332/1115
1,125	F 00R J01 022	F 00R J04 728	F 00R J04 239	11-23-332/1125
1,135	F 00R J01 023	F 00R J04 729	F 00R J04 240	11-23-332/1135
1,145	F 00R J01 024	F 00R J04 730	F 00R J04 241	11-23-332/1145
1,155	-	-	-	11-23-332/1155
1,165	-	-	-	11-23-332/1165
1,175	-	-	-	11-23-332/1175
1,185	-	-	-	11-23-332/1185
1,195	-	-	-	11-23-332/1195
1,205	-	-	-	11-23-332/1205
1,215	-	-	-	11-23-332/1215
1,225	-	-	-	11-23-332/1225
1,235	-	-	-	11-23-332/1235
1,245	-	-	-	11-23-332/1245
1,255	-	-	-	11-23-332/1255
1,265	-	-	-	11-23-332/1265
1,275	-	-	-	11-23-332/1275
1,285	-	-	-	11-23-332/1285
1,295	-	-	-	11-23-332/1295
1,305	-	-	-	11-23-332/1305
1,315	-	-	-	11-23-332/1315
1,325	-	-	-	11-23-332/1325
1,335	-	-	-	11-23-332/1335
1,345	-	-	-	11-23-332/1345
1,355	-	-	-	11-23-332/1355
1,365	-	-	-	11-23-332/1365
1,375	-	-	-	11-23-332/1375
1,385	-	-	-	11-23-332/1385



COMMON RAIL

BOSCH

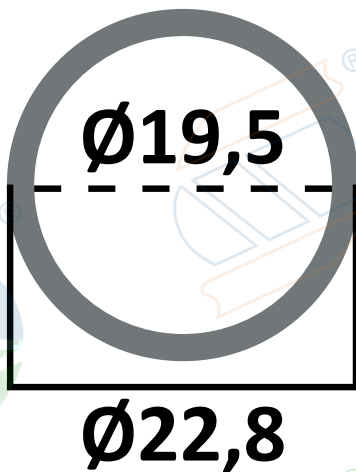

da 1,30.. a 1,80
 ALTRE MISURE DISPONIBILI A RICHIESTA
 OTHER SIZES AVAILABLE UPON REQUEST
 OTROS TAMAÑOS DISPONIBLES BAJO PETICIÓN
 ДРУГИЕ РАЗМЕРЫ ДОСТУПНЫ ПО ЗАПРОСУ
 根據要求提供其它尺寸

CODICE OMS	SPESORE	INCREMENTO	N° PEZZI
11-23-287	DA 1,34 A 1,76	0,02	220



HANDBAG | VALIGETTA 24 POSIZIONI | POSITION

CODICE OMS	SPESORE	INCREMENTO	N° PEZZI
11-23-728	DA 1,30 A 1,80	0,01	510



HANDBAG | VALIGETTA 54 POSIZIONI | POSITION

CODICE SINGOLI SPESSORI CODE INDIVIDUAL THICKNESSES

MISURA	COD. OMS
1,30	11-23-728/130
1,31	11-23-728/131
1,32	11-23-728/132
1,33	11-23-728/133
1,34	11-23-728/134
1,35	11-23-728/135
1,36	11-23-728/136
1,37	11-23-728/137
1,38	11-23-728/138
1,39	11-23-728/139
1,40	11-23-728/140
1,41	11-23-728/141
1,42	11-23-728/142
1,43	11-23-728/143
1,44	11-23-728/144
1,45	11-23-728/145
1,46	11-23-728/146
1,47	11-23-728/147
1,48	11-23-728/148
1,49	11-23-728/149
1,50	11-23-728/150
1,51	11-23-728/151
1,52	11-23-728/152
1,53	11-23-728/153
1,54	11-23-728/154
1,55	11-23-728/155
1,56	11-23-728/156
1,57	11-23-728/157
1,58	11-23-728/158
1,59	11-23-728/159
1,60	11-23-728/160
1,61	11-23-728/161
1,62	11-23-728/162
1,63	11-23-728/163
1,64	11-23-728/164
1,65	11-23-728/165
1,66	11-23-728/166
1,67	11-23-728/167
1,68	11-23-728/168
1,69	11-23-728/169
1,70	11-23-728/170
1,71	11-23-728/171
1,72	11-23-728/172
1,73	11-23-728/173
1,74	11-23-728/174
1,75	11-23-728/175
1,76	11-23-728/176
1,77	11-23-728/177
1,78	11-23-728/178
1,79	11-23-728/179
1,80	11-23-728/180



BOSCH

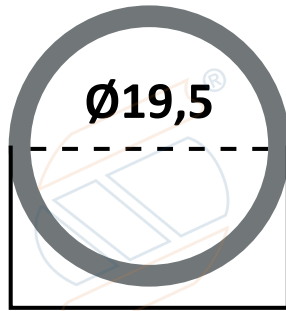
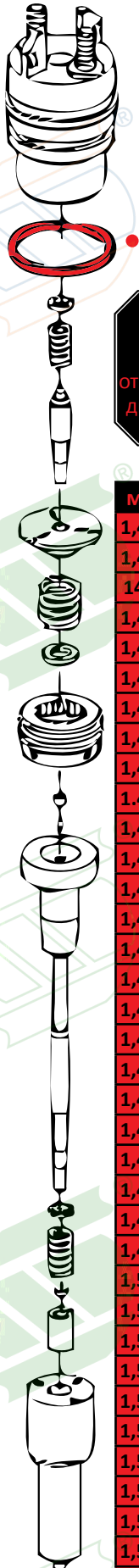

Ø22,8

da 1,400.. a 1,684
 ALTRE MISURE DISPONIBILI A RICHIESTA
 OTHER SIZES AVAILABLE UPON REQUEST
 OTROS TAMAÑOS DISPONIBLES BAJO PETICIÓN
 ДРУГИЕ РАЗМЕРЫ ДОСТУПНЫ ПО ЗАПРОСУ
 根據要求提供其它尺寸

CODICE OMS	SPESSORE	INCREMENTO	N° PEZZI
11-23-385	DA 1,512 A 1,684	0,004	440



HANDBAG | VALIGETTA 54 POSIZIONI | POSITION

TABELLA CODICI ORIGINALI ORIGINAL CODES TABLE

MIS.	RIF. ORIG.	RIF. ORIG. 2	RIF. ORIG. 3	COD. OMS	MIS.	RIF. ORIG.	RIF. ORIG. 2	RIF. ORIG. 3	COD. OMS
1,400	-	-	-	11-23-287/1400	1,544	F 00R J00 885	F 00R J04 678	F 00R J04 189	11-23-287/1544
1,404	-	-	-	11-23-287/1404	1,548	F 00R J00 887	F 00R J04 679	F 00R J04 190	11-23-287/1548
1408	-	-	-	11-23-287/1408	1,552	F 00R J00 889	F 00R J04 680	F 00R J04 191	11-23-287/1552
1,412	-	-	-	11-23-287/1412	1,556	F 00R J00 891	F 00R J04 681	F 00R J04 192	11-23-287/1556
1,416	-	-	-	11-23-287/1416	1,560	F 00R J00 893	F 00R J04 682	F 00R J04 193	11-23-287/1560
1,420	-	-	-	11-23-287/1420	1,564	F 00R J00 895	F 00R J04 683	F 00R J04 194	11-23-287/1564
1,424	-	-	-	11-23-287/1424	1,568	F 00R J00 897	F 00R J04 684	F 00R J04 195	11-23-287/1568
1,428	-	-	-	11-23-287/1428	1,572	F 00R J00 899	F 00R J04 685	F 00R J04 196	11-23-287/1572
1,432	-	-	-	11-23-287/1432	1,576	F 00R J00 901	F 00R J04 686	F 00R J04 197	11-23-287/1576
1,436	-	-	-	11-23-287/1436	1,580	F 00R J00 903	F 00R J04 687	F 00R J04 198	11-23-287/1580
1,440	-	-	-	11-23-287/1440	1,584	F 00R J00 905	F 00R J04 688	F 00R J04 199	11-23-287/1584
1,444	-	-	-	11-23-287/1444	1,588	F 00R J00 907	F 00R J04 689	F 00R J04 200	11-23-287/1588
1,448	-	-	-	11-23-287/1448	1,592	F 00R J00 909	F 00R J04 690	F 00R J04 201	11-23-287/1592
1,452	-	-	-	11-23-287/1452	1,596	F 00R J00 911	F 00R J04 691	F 00R J04 202	11-23-287/1596
1,456	-	-	-	11-23-287/1456	1,600	F 00R J00 913	F 00R J04 692	F 00R J04 203	11-23-287/1600
1,460	-	-	-	11-23-287/1460	1,604	F 00R J00 915	F 00R J04 693	F 00R J04 204	11-23-287/1604
1,464	-	-	-	11-23-287/1464	1,608	F 00R J00 917	F 00R J04 694	F 00R J04 205	11-23-287/1608
1,468	-	-	-	11-23-287/1468	1,612	F 00R J00 919	F 00R J04 695	F 00R J04 206	11-23-287/1612
1,472	-	-	-	11-23-287/1472	1,616	F 00R J00 921	F 00R J04 696	F 00R J04 207	11-23-287/1616
1,476	-	-	-	11-23-287/1476	1,620	F 00R J00 923	F 00R J04 697	F 00R J04 208	11-23-287/1620
1,480	-	-	-	11-23-287/1480	1,624	F 00R J00 925	F 00R J04 698	F 00R J04 209	11-23-287/1624
1,484	-	-	-	11-23-287/1484	1,628	F 00R J00 927	F 00R J04 699	F 00R J04 210	11-23-287/1628
1,488	-	-	-	11-23-287/1488	1,632	F 00R J00 929	F 00R J04 700	F 00R J04 211	11-23-287/1632
1,492	-	-	-	11-23-287/1492	1,636	F 00R J00 931	F 00R J04 701	F 00R J04 212	11-23-287/1636
1,496	-	-	-	11-23-287/1496	1,640	F 00R J00 933	F 00R J04 702	F 00R J04 213	11-23-287/1640
1,500	-	-	-	11-23-287/1500	1,644	F 00R J00 935	F 00R J04 703	F 00R J04 214	11-23-287/1644
1,504	-	-	-	11-23-287/1504	1,648	F 00R J00 937	F 00R J04 704	F 00R J04 215	11-23-287/1648
1,508	-	-	-	11-23-287/1508	1,652	F 00R J00 939	F 00R J04 705	F 00R J04 216	11-23-287/1652
1,512	F 00R J00 869	F 00R J04 670	F 00R J04 181	11-23-287/1512	1,656	F 00R J00 941	F 00R J04 706	F 00R J04 217	11-23-287/1656
1,516	F 00R J00 871	F 00R J04 671	F 00R J04 182	11-23-287/1516	1,660	F 00R J00 943	F 00R J04 707	F 00R J04 218	11-23-287/1660
1,520	F 00R J00 873	F 00R J04 672	F 00R J04 183	11-23-287/1520	1,664	F 00R J00 945	F 00R J04 708	F 00R J04 219	11-23-287/1664
1,524	F 00R J00 875	F 00R J04 673	F 00R J04 184	11-23-287/1524	1,668	F 00R J00 947	F 00R J04 709	F 00R J04 220	11-23-287/1668
1,528	F 00R J00 877	F 00R J04 674	F 00R J04 185	11-23-287/1528	1,672	F 00R J00 949	F 00R J04 710	F 00R J04 221	11-23-287/1672
1,532	F 00R J00 879	F 00R J04 675	F 00R J04 186	11-23-287/1532	1,676	F 00R J00 951	F 00R J04 711	F 00R J04 222	11-23-287/1676
1,536	F 00R J00 881	F 00R J04 676	F 00R J04 187	11-23-287/1536	1,680	F 00R J00 953	F 00R J04 712	F 00R J04 223	11-23-287/1680
1,540	F 00R J00 883	F 00R J04 677	F 00R J04 188	11-23-287/1540	1,684	F 00R J00 955	F 00R J04 713	F 00R J04 224	11-23-287/1684



COMMON RAIL

BOSCH

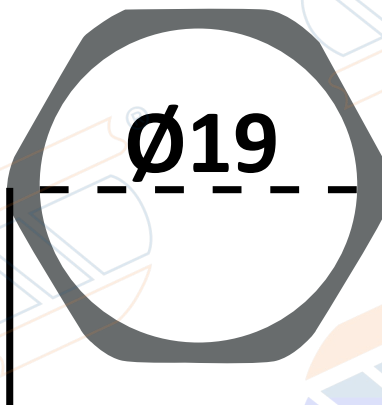
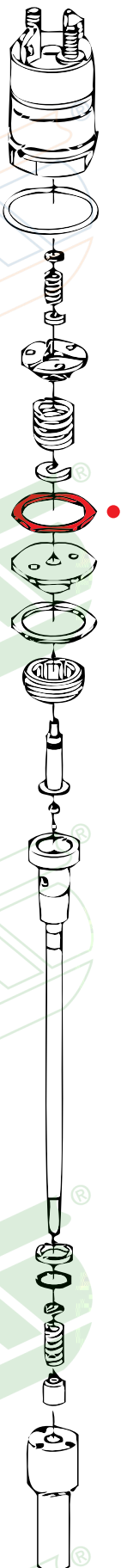

Ø22

da 0,90.. a 1,60

ALTRE MISURE DISPONIBILI A RICHIESTA

OTHER SIZES AVAILABLE UPON REQUEST

OTROS TAMAÑOS DISPONIBLES BAJO PETICIÓN

ДРУГИЕ РАЗМЕРЫ ДОСТУПНЫ ПО ЗАПРОСУ

根據要求提供其它尺寸

CODICE OMS	SPESORE	INCREMENTO	N° PEZZI
11-23-273	DA 0,90 A 1,00	0,01	110
11-23-235	DA 1,00 A 1,10	0,01	110
11-23-301	DA 1,30 A 1,40	0,01	110



HANDBAG | VALIGETTA 12 POSIZIONI | POSITION

CODICE OMS	SPESORE	INCREMENTO	N° PEZZI
11-23-387	DA 1,21 A 1,38	0,01	180



HANDBAG | VALIGETTA 24 POSIZIONI | POSITION

CODICE OMS	SPESORE	INCREMENTO	N° PEZZI
11-23-386	DA 0,90 A 1,40	0,01	510

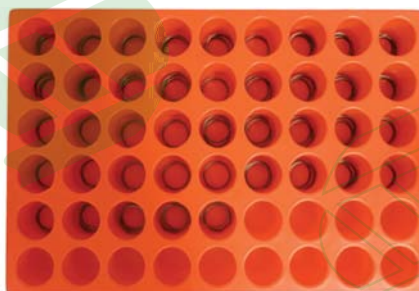

HANDBAG | VALIGETTA 54 POSIZIONI | POSITION



BOSCH

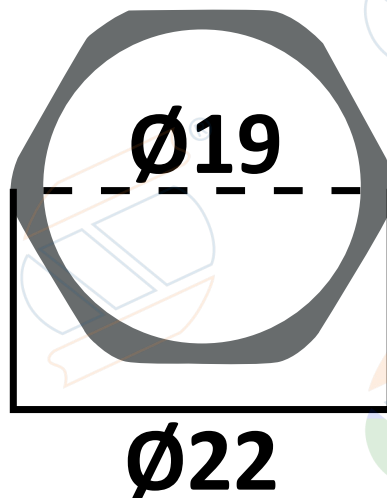

TABELLA CODICI ORIGINALI
ORIGINAL CODES TABLE

MIS.	RIF. ORIG.	RIF. ORIG. 2	RIF. ORIG. 3	COD. OMS	MIS.	RIF. ORIG.	RIF. ORIG. 2	RIF. ORIG. 3	COD. OMS
0,90	-	-	-	11-23-235/090	1,26	F 00R J00 130	-	F 00R J04 143	11-23-235/126
0,91	-	-	-	11-23-235/091	1,27	F 00R J00 132	F 00R J04 635	F 00R J04 144	11-23-235/127
0,92	-	-	-	11-23-235/092	1,28	F 00R J00 134	-	F 00R J04 145	11-23-235/128
0,93	-	-	-	11-23-235/093	1,29	F 00R J00 136	-	F 00R J04 146	11-23-235/129
0,94	-	-	-	11-23-235/094	1,30	F 00R J00 138	-	F 00R J04 147	11-23-235/130
0,95	-	-	-	11-23-235/095	1,31	F 00R J00 140	-	F 00R J04 148	11-23-235/131
0,96	-	-	-	11-23-235/096	1,32	F 00R J00 142	-	F 00R J04 149	11-23-235/132
0,97	-	-	-	11-23-235/097	1,33	F 00R J00 144	-	F 00R J04 150	11-23-235/133
0,98	-	-	-	11-23-235/098	1,34	F 00R J00 146	-	F 00R J04 151	11-23-235/134
0,99	-	-	-	11-23-235/099	1,35	F 00R J00 148	F 00R J04 643	F 00R J04 152	11-23-235/135
1,00	-	-	-	11-23-235/100	1,36	F 00R J00 150	-	F 00R J04 153	11-23-235/136
1,01	-	-	-	11-23-235/101	1,37	F 00R J00 152	F 00R J04 645	F 00R J04 154	11-23-235/137
1,02	-	-	-	11-23-235/102	1,38	F 00R J00 154	F 00R J04 646	F 00R J04 155	11-23-235/138
1,03	-	-	-	11-23-235/103	1,39	-	-	-	11-23-235/139
1,04	-	-	-	11-23-235/104	1,40	-	-	-	11-23-235/140
1,05	-	-	-	11-23-235/105	1,41	-	-	-	11-23-235/141
1,06	-	-	-	11-23-235/106	1,42	-	-	-	11-23-235/142
1,07	-	-	-	11-23-235/107	1,43	-	-	-	11-23-235/143
1,08	-	-	-	11-23-235/108	1,44	-	-	-	11-23-235/144
1,09	-	-	-	11-23-235/109	1,45	-	-	-	11-23-235/145
1,10	-	-	-	11-23-235/110	1,46	-	-	-	11-23-235/146
1,11	-	-	-	11-23-235/111	1,47	-	-	-	11-23-235/147
1,12	-	-	-	11-23-235/112	1,48	-	-	-	11-23-235/148
1,13	-	-	-	11-23-235/113	1,49	-	-	-	11-23-235/149
1,14	-	-	-	11-23-235/114	1,50	-	-	-	11-23-235/150
1,15	-	-	-	11-23-235/115	1,51	-	-	-	11-23-235/151
1,16	-	-	-	11-23-235/116	1,52	-	-	-	11-23-235/152
1,17	-	-	-	11-23-235/117	1,53	-	-	-	11-23-235/153
1,18	-	-	-	11-23-235/118	1,54	-	-	-	11-23-235/154
1,19	-	-	-	11-23-235/119	1,55	-	-	-	11-23-235/155
1,20	-	-	-	11-23-235/120	1,56	-	-	-	11-23-235/156
1,21	F 00R J00 120	F 00R J04 629	F 00R J04 138	11-23-235/121	1,57	-	-	-	11-23-235/157
1,22	F 00R J00 122	F 00R J04 630	F 00R J04 139	11-23-235/122	1,58	-	-	-	11-23-235/158
1,23	F 00R J00 124	F 00R J04 631	F 00R J04 140	11-23-235/123	1,59	-	-	-	11-23-235/159
1,24	F 00R J00 126	F 00R J04 632	F 00R J04 141	11-23-235/124	1,60	-	-	-	11-23-235/160
1,25	F 00R J00 128	F 00R J04 633	F 00R J04 142	11-23-235/125					

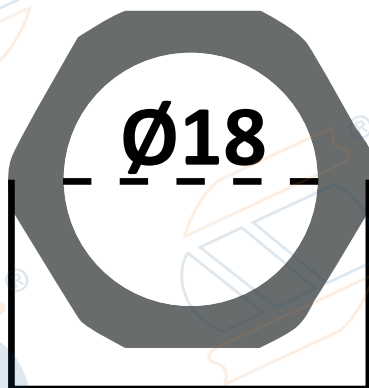
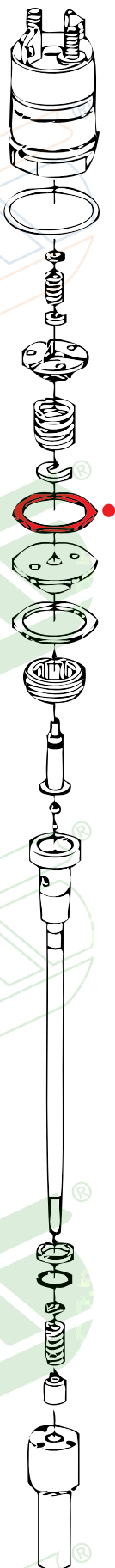

COMMON RAIL

BOSCH



Ø22

da 0,90.. a 1,40

ALTRE MISURE DISPONIBILI A RICHIESTA
OTHER SIZES AVAILABLE UPON REQUEST
OTROS TAMAÑOS DISPONIBLES BAJO PETICIÓN
ДРУГИЕ РАЗМЕРЫ ДОСТУПНЫ ПО ЗАПРОСУ
根據要求提供其它尺寸

CODICE OMS	SPESORE	INCREMENTO	N° PEZZI
11-23-325	DA 0,90 A 1,00	0,01	110
11-23-288	DA 1,00 A 1,10	0,01	110



HANDBAG | VALIGETTA 12 POSIZIONI | POSITION

CODICE OMS	SPESORE	INCREMENTO	N° PEZZI
11-23-397	DA 0,90 A 1,12	0,01	230

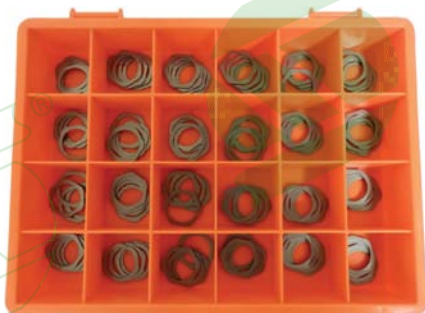

HANDBAG | VALIGETTA 24 POSIZIONI | POSITION

CODICE SINGOLI SPESSORI
CODE INDIVIDUAL THICKNESSES

MISURA	COD. OMS
0,90	11-23-288/090
0,91	11-23-288/091
0,92	11-23-288/092
0,93	11-23-288/093
0,94	11-23-288/094
0,95	11-23-288/095
0,96	11-23-288/096
0,97	11-23-288/097
0,98	11-23-288/098
0,99	11-23-288/099
1,00	11-23-288/100
1,01	11-23-288/101
1,02	11-23-288/102
1,03	11-23-288/103
1,04	11-23-288/104
1,05	11-23-288/105
1,06	11-23-288/106
1,07	11-23-288/107
1,08	11-23-288/108
1,09	11-23-288/109
1,10	11-23-288/110
1,11	11-23-288/111
1,12	11-23-288/112
1,13	11-23-288/113
1,14	11-23-288/114
1,15	11-23-288/115
1,16	11-23-288/116
1,17	11-23-288/117
1,18	11-23-288/118
1,19	11-23-288/119
1,20	11-23-288/120
1,21	11-23-288/121
1,22	11-23-288/122
1,23	11-23-288/123
1,24	11-23-288/124
1,25	11-23-288/125
1,26	11-23-288/126
1,27	11-23-288/127
1,28	11-23-288/128
1,29	11-23-288/129
1,30	11-23-288/130
1,31	11-23-288/131
1,32	11-23-288/132
1,33	11-23-288/133
1,34	11-23-288/134
1,35	11-23-288/135
1,36	11-23-288/136
1,37	11-23-288/137
1,38	11-23-288/138
1,39	11-23-288/139
1,40	11-23-288/140

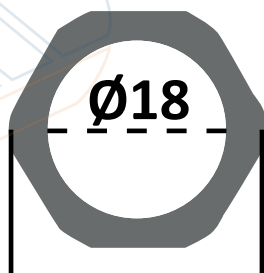
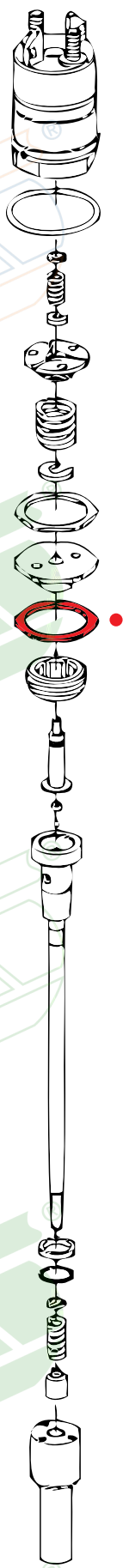

Ø22

da 0,950.. a 1,150

ALTRE MISURE DISPONIBILI A RICHIESTA

OTHER SIZES AVAILABLE UPON REQUEST

OTROS TAMAÑOS DISPONIBLES BAJO PETICIÓN

ДРУГИЕ РАЗМЕРЫ ДОСТУПНЫ ПО ЗАПРОСУ

根據要求提供其它尺寸

CODICE OMS	SPESORE	INCREMENTO	N° PEZZI
11-23-388/1	DA 1,058 A 1,150	0,004	240

HANDBAG | VALIGETTA 24 POSIZIONI | POSITION

CODICE OMS	SPESORE	INCREMENTO	N° PEZZI
11-23-388	DA 0,950 A 1,054	0,004	270

HANDBAG | VALIGETTA 36 POSIZIONI | POSITION

TABELLA CODICI ORIGINALI
ORIGINAL CODES TABLE

MISURA	RIF. ORIGINALE	RIF. ORIGINALE	COD. OMS	MISURA	RIF. ORIGINALE	COD. OMS
0,950	F 00R J00 024	F 00R J04 091	11-23-388/0950	1,058	-	11-23-388/1058
0,954	F 00R J00 026	F 00R J04 092	11-23-388/0954	1,062	-	11-23-388/1062
0,958	F 00R J00 028	F 00R J04 093	11-23-388/0958	1,066	-	11-23-388/1066
0,962	F 00R J00 030	F 00R J04 094	11-23-388/0962	1,070	-	11-23-388/1070
0,966	F 00R J00 032	F 00R J04 095	11-23-388/0966	1,074	-	11-23-388/1074
0,970	F 00R J00 034	F 00R J04 096	11-23-388/0970	1,078	-	11-23-388/1078
0,974	F 00R J00 036	F 00R J04 097	11-23-388/0974	1,082	-	11-23-388/1082
0,978	F 00R J00 038	F 00R J04 098	11-23-388/0978	1,086	-	11-23-388/1086
0,982	F 00R J00 040	F 00R J04 099	11-23-388/0982	1,090	-	11-23-388/1090
0,986	F 00R J00 042	F 00R J04 100	11-23-388/0986	1,094	-	11-23-388/1094
0,990	F 00R J00 044	F 00R J04 101	11-23-388/0990	1,098	-	11-23-388/1098
0,994	F 00R J00 046	F 00R J04 102	11-23-388/0994	1,102	-	11-23-388/1102
0,998	F 00R J00 048	F 00R J04 103	11-23-388/0998	1,106	-	11-23-388/1106
1,002	F 00R J00 050	F 00R J04 104	11-23-388/1002	1,110	-	11-23-388/1110
1,006	F 00R J00 052	F 00R J04 105	11-23-388/1006	1,114	-	11-23-388/1114
1,010	F 00R J00 054	F 00R J04 106	11-23-388/1010	1,118	-	11-23-388/1118
1,014	F 00R J00 056	F 00R J04 107	11-23-388/1014	1,122	-	11-23-388/1122
1,018	F 00R J00 058	F 00R J04 108	11-23-388/1018	1,126	-	11-23-388/1126
1,022	F 00R J00 060	F 00R J04 109	11-23-388/1022	1,130	-	11-23-388/1130
1,026	F 00R J00 062	F 00R J04 110	11-23-388/1026	1,134	-	11-23-388/1134
1,030	F 00R J00 064	F 00R J04 111	11-23-388/1030	1,138	-	11-23-388/1138
1,034	F 00R J00 066	F 00R J04 112	11-23-388/1034	1,142	-	11-23-388/1142
1,038	F 00R J00 068	F 00R J04 113	11-23-388/1038	1,146	-	11-23-388/1146
1,042	F 00R J00 070	F 00R J04 114	11-23-388/1042	1,150	-	11-23-388/1150
1,046	F 00R J00 072	F 00R J04 115	11-23-388/1046			
1,050	F 00R J00 074	F 00R J04 116	11-23-388/1050			
1,054	F 00R J00 076	F 00R J04 117	11-23-388/1054			



COMMON RAIL

BOSCH

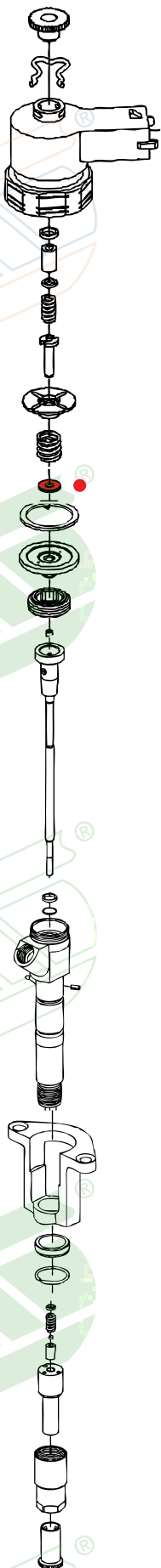

Ø9

da 0,78.. a 1,25

ALTRE MISURE DISPONIBILI A RICHIESTA

OTHER SIZES AVAILABLE UPON REQUEST

OTROS TAMAÑOS DISPONIBLES BAJO PETICIÓN

ДРУГИЕ РАЗМЕРЫ ДОСТУПНЫ ПО ЗАПРОСУ

根據要求提供其它尺寸

CODICE OMS	SPESSORE	INCREMENTO	N° PEZZI
11-23-389	DA 0,78 A 1,25	0,01	480

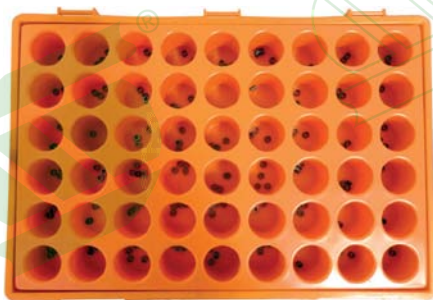

HANDBAG | VALIGETTA 54 POSIZIONI | POSITION

TABELLA CODICI ORIGINALI ORIGINAL CODES TABLE

MISURA	RIF. ORIGINALE	COD. OMS
0,78	-	11-23-389/078
0,79	-	11-23-389/079
0,80	-	11-23-389/080
0,81	-	11-23-389/081
0,82	F 00R J01 347	11-23-389/082
0,83	F 00R J01 349	11-23-389/083
0,84	F 00R J01 351	11-23-389/084
0,85	F 00R J01 353	11-23-389/085
0,86	F 00R J01 355	11-23-389/086
0,87	F 00R J01 357	11-23-389/087
0,88	F 00R J01 359	11-23-389/088
0,89	F 00R J01 361	11-23-389/089
0,90	F 00R J01 363	11-23-389/090
0,91	F 00R J01 365	11-23-389/091
0,92	F 00R J01 367	11-23-389/092
0,93	F 00R J01 369	11-23-389/093
0,94	F 00R J01 371	11-23-389/094
0,95	F 00R J01 373	11-23-389/095
0,96	F 00R J01 375	11-23-389/096
0,97	F 00R J01 377	11-23-389/097
0,98	F 00R J01 379	11-23-389/098
0,99	F 00R J01 381	11-23-389/099
1,00	F 00R J01 383	11-23-389/100
1,01	F 00R J01 385	11-23-389/101
1,02	F 00R J01 387	11-23-389/102
1,03	F 00R J01 389	11-23-389/103
1,04	F 00R J01 391	11-23-389/104
1,05	F 00R J01 393	11-23-389/105
1,06	F 00R J01 395	11-23-389/106
1,07	F 00R J01 397	11-23-389/107
1,08	F 00R J01 399	11-23-389/108
1,09	F 00R J01 401	11-23-389/109
1,10	F 00R J01 403	11-23-389/110
1,11	F 00R J01 405	11-23-389/111
1,12	F 00R J01 407	11-23-389/112
1,13	F 00R J01 409	11-23-389/113
1,14	F 00R J01 411	11-23-389/114
1,15	F 00R J01 413	11-23-389/115
1,16	F 00R J01 415	11-23-389/116
1,17	F 00R J01 417	11-23-389/117
1,18	F 00R J01 419	11-23-389/118
1,19	-	11-23-389/119
1,20	-	11-23-389/120
1,21	-	11-23-389/121
1,22	-	11-23-389/122
1,23	-	11-23-389/123
1,24	-	11-23-389/124
1,25	-	11-23-389/125

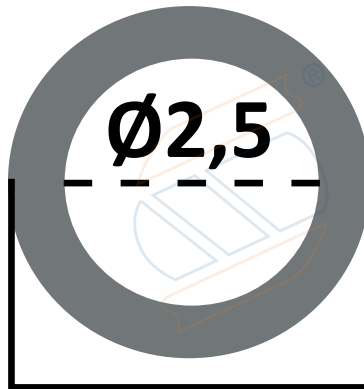

Ø5,3

da 1,00.. a 2,00

ALTRE MISURE DISPONIBILI A RICHIESTA

OTHER SIZES AVAILABLE UPON REQUEST

OTROS TAMAÑOS DISPONIBLES BAJO PETICIÓN

ДРУГИЕ РАЗМЕРЫ ДОСТУПНЫ ПО ЗАПРОСУ

根據要求提供其它尺寸

CODICE OMS	SPESORE	INCREMENTO	N° PEZZI
11-23-272	DA 1,72 A 1,90	0,02	100

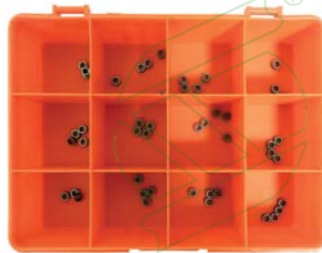

HANDBAG | VALIGETTA 12 POSIZIONI | POSITION

CODICE OMS	SPESORE	INCREMENTO	N° PEZZI
11-23-231	DA 1,20 A 1,70	0,02	240

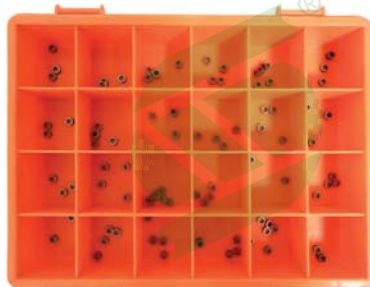

HANDBAG | VALIGETTA 24 POSIZIONI | POSITION

CODICE SINGOLI SPESSORI
CODE INDIVIDUAL THICKNESSES

MISURA	COD. OMS
1,00	11-23-231/100
1,02	11-23-231/102
1,04	11-23-231/104
1,05	11-23-231/105
1,06	11-23-231/106
1,08	11-23-231/108
1,10	11-23-231/110
1,12	11-23-231/112
1,14	11-23-231/114
1,15	11-23-231/115
1,16	11-23-231/116
1,18	11-23-231/118
1,20	11-23-231/120
1,22	11-23-231/122
1,24	11-23-231/124
1,25	11-23-231/125
1,26	11-23-231/126
1,28	11-23-231/128
1,30	11-23-231/130
1,32	11-23-231/132
1,34	11-23-231/134
1,35	11-23-231/135
1,36	11-23-231/136
1,38	11-23-231/138
1,40	11-23-231/140
1,42	11-23-231/142
1,44	11-23-231/144
1,45	11-23-231/145
1,46	11-23-231/146
1,48	11-23-231/148
1,50	11-23-231/150
1,52	11-23-231/152
1,54	11-23-231/154
1,55	11-23-231/155
1,56	11-23-231/156
1,58	11-23-231/158
1,60	11-23-231/160
1,62	11-23-231/162
1,64	11-23-231/164
1,65	11-23-231/165
1,66	11-23-231/166
1,68	11-23-231/168
1,70	11-23-231/170
1,72	11-23-231/172
1,74	11-23-231/174
1,75	11-23-231/175
1,76	11-23-231/176
1,78	11-23-231/178
1,80	11-23-231/180
1,82	11-23-231/182
1,84	11-23-231/184
1,85	11-23-231/185
1,86	11-23-231/186
1,88	11-23-231/188
1,90	11-23-231/190
1,92	11-23-231/192
1,94	11-23-231/194
1,95	11-23-231/195
1,96	11-23-231/196
1,98	11-23-231/198
2,00	11-23-231/200



COMMON RAIL

BOSCH



Ø2,7

Ø5,4

da 1,155.. a 1,265

ALTRE MISURE DISPONIBILI A RICHIESTA
OTHER SIZES AVAILABLE UPON REQUEST
OTROS TAMAÑOS DISPONIBLES BAJO PETICIÓN
ДРУГИЕ РАЗМЕРЫ ДОСТУПНЫ ПО ЗАПРОСУ
根據要求提供其它尺寸

CODICE OMS	SPESORE	INCREMENTO	N° PEZZI
11-23-396	DA 1,155 A 1,265	0,10	120



HANDBAG | VALIGETTA 12 POSIZIONI | POSITION

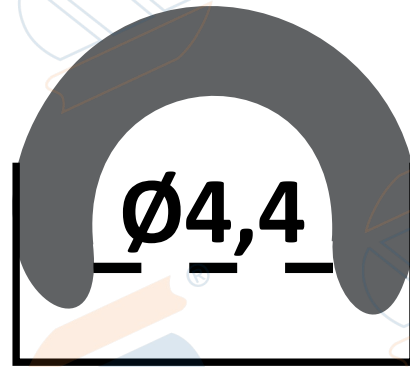

Ø4,4

Ø9,8

da 1,24.. a 1,35

ALTRE MISURE DISPONIBILI A RICHIESTA
OTHER SIZES AVAILABLE UPON REQUEST
OTROS TAMAÑOS DISPONIBLES BAJO PETICIÓN
ДРУГИЕ РАЗМЕРЫ ДОСТУПНЫ ПО ЗАПРОСУ
根據要求提供其它尺寸

CODICE OMS	SPESORE	INCREMENTO	N° PEZZI
11-23-409/1	DA 1,24 A 1,35	0,01	120



HANDBAG | VALIGETTA 12 POSIZIONI | POSITION

TABELLA CODICI ORIGINALI ORIGINAL CODES TABLE

MISURA	RIF. ORIGINALE	RIF. ORIGINALE NEW	COD. OMS
1,155	F 00V C18 300	F 00Z C99 262	11-23-396/1155
1,165	F 00V C18 302	F 00Z C99 263	11-23-396/1165
1,175	F 00V C18 304	F 00Z C99 264	11-23-396/1175
1,185	F 00V C18 306	F 00Z C99 265	11-23-396/1185
1,195	F 00V C18 308	F 00Z C99 266	11-23-396/1195
1,205	F 00V C18 310	F 00Z C99 267	11-23-396/1205
1,215	F 00V C18 312	F 00Z C99 268	11-23-396/1215
1,225	F 00V C18 314	F 00Z C99 269	11-23-396/1225
1,235	F 00V C18 316	F 00Z C99 270	11-23-396/1235
1,245	F 00V C18 318	F 00Z C99 271	11-23-396/1245
1,255	F 00V C18 320	F 00Z C99 272	11-23-396/1255
1,265	F 00V C18 322	F 00Z C99 273	11-23-396/1265

CODICE SINGOLI SPESSORI CODE INDIVIDUAL THICKNESSES

MISURA	COD. OMS
1,24	11-23-409/124
1,25	11-23-409/125
1,26	11-23-409/126
1,27	11-23-409/127
1,28	11-23-409/128
1,29	11-23-409/129
1,30	11-23-409/130
1,31	11-23-409/131
1,32	11-23-409/132
1,33	11-23-409/133
1,34	11-23-409/134
1,35	11-23-409/135



PLD 1B100-PLD1D110

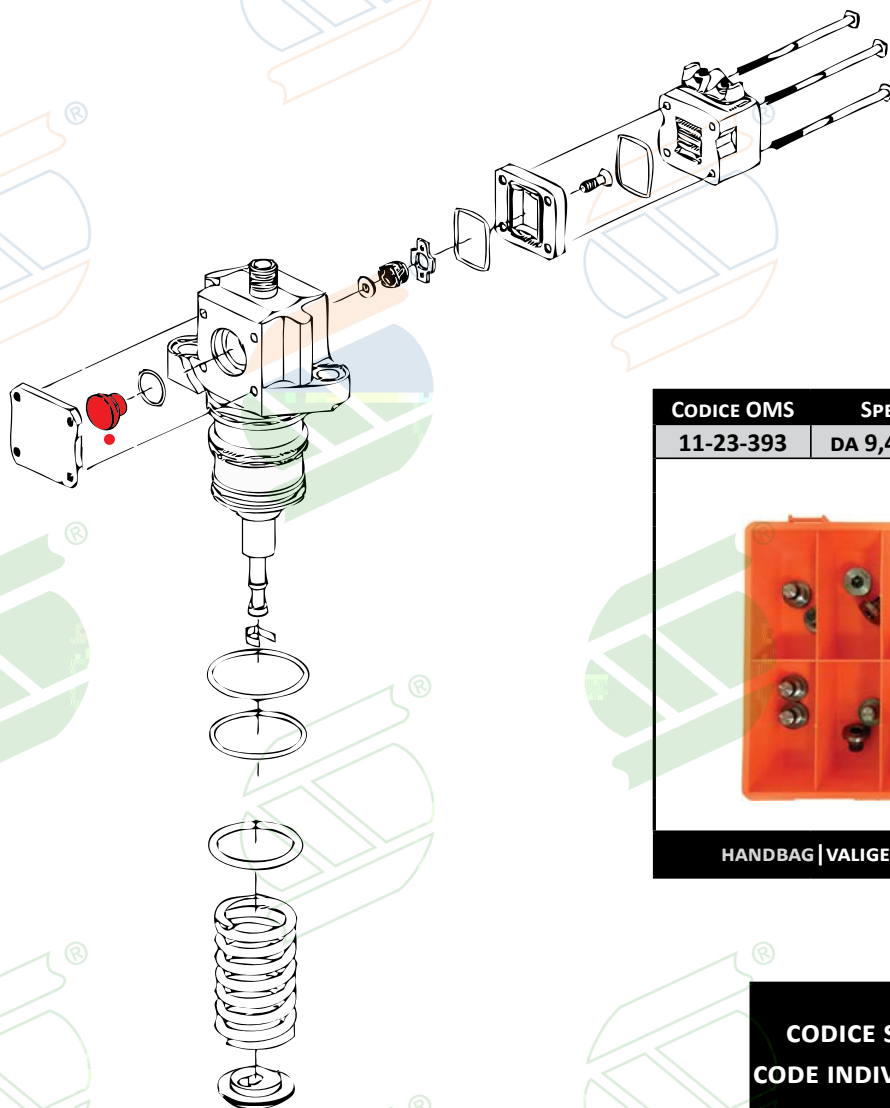

CODICE OMS	SPESORE	INCREMENTO	N° PEZZI
11-23-393	DA 9,40 A 9,60	0,02	55

HANDBAG | VALIGETTA 12 POSIZIONI | POSITION

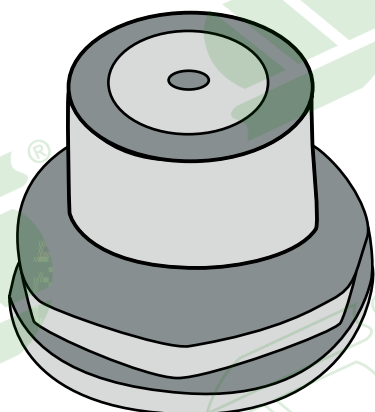

CODICE SINGOLI SPessori CODE INDIVIDUAL THICKNESSES	
MISURA	COD. OMS
9,40	11-23-393/940
9,42	11-23-393/942
9,44	11-23-393/944
9,46	11-23-393/946
9,48	11-23-393/948
9,50	11-23-393/950
9,52	11-23-393/952
9,54	11-23-393/954
9,56	11-23-393/956
9,58	11-23-393/958
9,60	11-23-393/960



INIETTORE POMPA

PDE-100-90

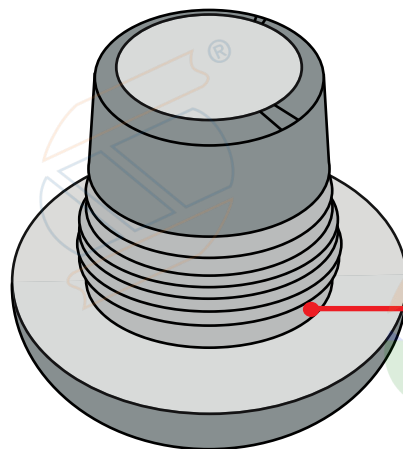

CON SEDE OR
with seat OR

da 14,66.. a 14,88

ALTRE MISURE DISPONIBILI A RICHIESTA

OTHER SIZES AVAILABLE UPON REQUEST

OTROS TAMAÑOS DISPONIBLES BAJO PETICIÓN

ДРУГИЕ РАЗМЕРЫ ДОСТУПНЫ ПО ЗАПРОСУ

根據要求提供其它尺寸

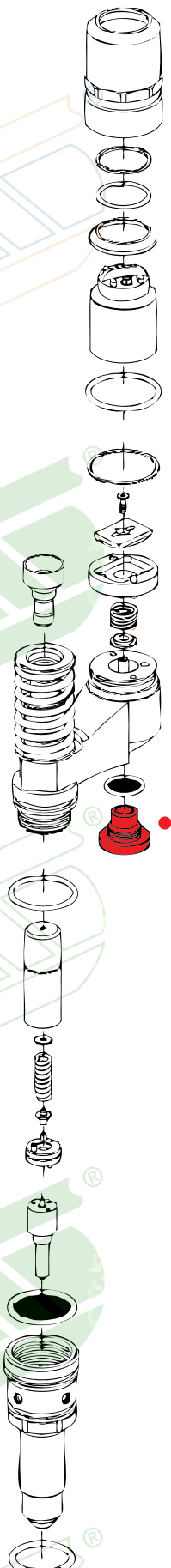

CODICE OMS	SPESORE	INCREMENTO	N° PEZZI
11-23-390	DA 14,66 A 14,88	0,02	60

HANDBAG | VALIGETTA 12 POSIZIONI | POSITION

CODICE SINGOLI SPESSORI CODE INDIVIDUAL THICKNESSES	
MISURA	COD. OMS
14,66	11-23-390/1466
14,68	11-23-390/1468
14,70	11-23-390/1470
14,72	11-23-390/1472
14,74	11-23-390/1474
14,76	11-23-390/1476
14,78	11-23-390/1478
14,80	11-23-390/1480
14,82	11-23-390/1482
14,84	11-23-390/1484
14,86	11-23-390/1486
14,88	11-23-390/1488



PDE-100-90

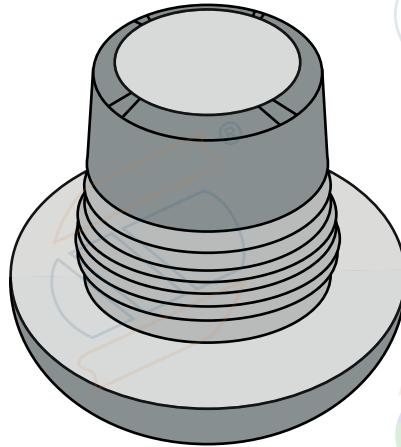

da 14,56.. a 15,10

ALTRE MISURE DISPONIBILI A RICHIESTA
 OTHER SIZES AVAILABLE UPON REQUEST
 OTROS TAMAÑOS DISPONIBLES BAJO PETICIÓN
 ДРУГИЕ РАЗМЕРЫ ДОСТУПНЫ ПО ЗАПРОСУ
 根據要求提供其它尺寸

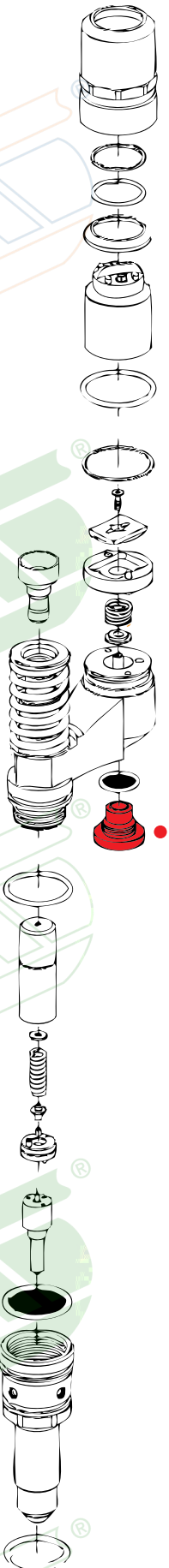

CODICE OMS	SPESSORE	INCREMENTO	N° PEZZI
11-23-391	DA 14,56 A 14,78	0,02	60

HANDBAG | VALIGETTA 12 POSIZIONI | POSITION

CODICE OMS	SPESSORE	INCREMENTO	N° PEZZI
11-23-392	DA 14,80 A 15,10	0,02	80

HANDBAG | VALIGETTA 24 POSIZIONI | POSITION

CODICE SINGOLI SPESSORI CODE INDIVIDUAL THICKNESSES	
MISURA	COD. OMS
14,56	11-23-391/1456
14,58	11-23-391/1458
14,60	11-23-391/1460
14,62	11-23-391/1462
14,64	11-23-391/1464
14,66	11-23-391/1466
14,68	11-23-391/1468
14,70	11-23-391/1470
14,72	11-23-391/1472
14,74	11-23-391/1474
14,76	11-23-391/1476
14,78	11-23-391/1478
14,80	11-23-391/1480
14,82	11-23-391/1482
14,84	11-23-391/1484
14,86	11-23-391/1486
14,88	11-23-391/1488
14,90	11-23-391/1490
14,92	11-23-391/1492
14,94	11-23-391/1494
14,96	11-23-391/1496
14,98	11-23-391/1498
15,00	11-23-391/1500
15,02	11-23-391/1502
15,04	11-23-391/1504
15,06	11-23-391/1506
15,08	11-23-391/1508
15,10	11-23-391/1510



PDE 75/80

BOSCH

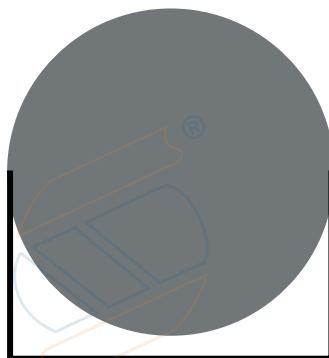

Ø8

da 1,00.. a 1,45

ALTRE MISURE DISPONIBILI A RICHIESTA

OTHER SIZES AVAILABLE UPON REQUEST

OTROS TAMAÑOS DISPONIBLES BAJO PETICIÓN

ДРУГИЕ РАЗМЕРЫ ДОСТУПНЫ ПО ЗАПРОСУ

根據要求提供其它尺寸

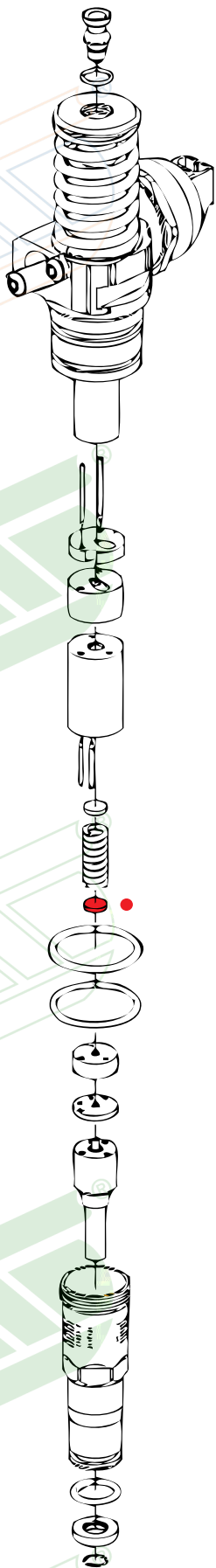

**TABELLA CODICI ORIGINALI
ORIGINAL CODES TABLE**

MISURA	RIF. ORIGINALE	COD. OMS
1,00	1 410 067 016	02-20-016/100
1,01	1 410 067 141	02-20-016/101
1,03	1 410 067 142	02-20-016/103
1,05	1 410 067 143	02-20-016/105
1,07	1 410 067 144	02-20-016/107
1,09	1 410 067 145	02-20-016/109
1,11	1 410 067 146	02-20-016/111
1,13	1 410 067 147	02-20-016/113
1,15	1 410 067 148	02-20-016/115
1,17	1 410 067 149	02-20-016/117
1,19	1 410 067 150	02-20-016/119
1,21	1 410 067 151	02-20-016/121
1,23	1 410 067 152	02-20-016/123
1,25	1 410 067 153	02-20-016/125
1,27	1 410 067 154	02-20-016/127
1,29	1 410 067 155	02-20-016/129
1,31	1 410 067 156	02-20-016/131
1,33	1 410 067 157	02-20-016/133
1,35	1 410 067 158	02-20-016/135
1,37	1 410 067 159	02-20-016/137
1,39	1 410 067 160	02-20-016/139
1,41	1 410 067 161	02-20-016/141
1,43	1 410 067 162	02-20-016/143
1,45	1 410 067 163	02-20-016/145





BOSCH

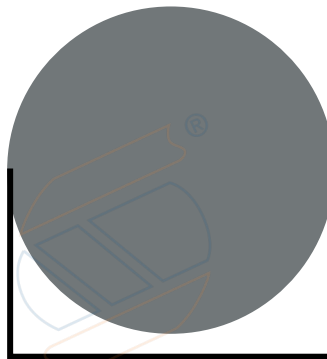
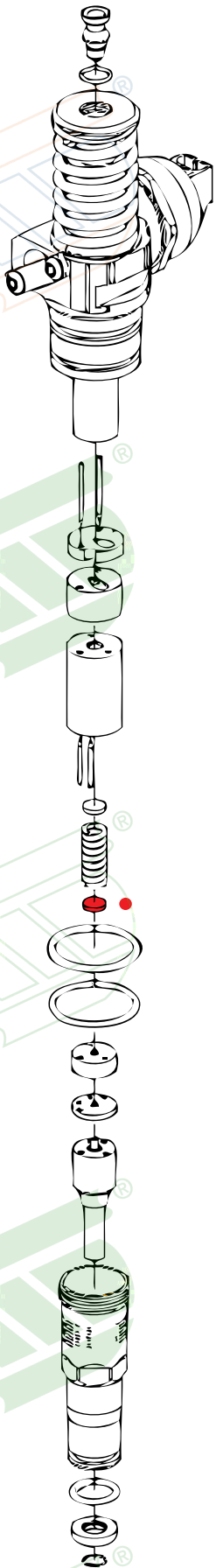

Ø6

da 1,00.. a 1,45

ALTRE MISURE DISPONIBILI A RICHIESTA
 OTHER SIZES AVAILABLE UPON REQUEST
 OTROS TAMAÑOS DISPONIBLES BAJO PETICIÓN
 ДРУГИЕ РАЗМЕРЫ ДОСТУПНЫ ПО ЗАПРОСУ
 根據要求提供其它尺寸

CODICE OMS	SPESSORE	INCREMENTO	N° PEZZI
02-20-017	DA 1,00 A 1,45	0,02	240



HANDBAG | VALIGETTA 24 POSIZIONI | POSITION

TABELLA CODICI ORIGINALI ORIGINAL CODES TABLE

MISURA	RIF. ORIGINALE	COD. OMS
1,00	-	02-20-017/100
1,01	-	02-20-017/101
1,03	-	02-20-017/103
1,05	-	02-20-017/105
1,07	-	02-20-017/107
1,09	-	02-20-017/109
1,11	1 410 067 304	02-20-017/111
1,13	1 410 067 306	02-20-017/113
1,15	1 410 067 308	02-20-017/115
1,17	1 410 067 310	02-20-017/117
1,19	1 410 067 312	02-20-017/119
1,21	1 410 067 314	02-20-017/121
1,23	1 410 067 316	02-20-017/123
1,25	1 410 067 318	02-20-017/125
1,27	1 410 067 320	02-20-017/127
1,29	1 410 067 322	02-20-017/129
1,31	1 410 067 324	02-20-017/131
1,33	1 410 067 326	02-20-017/133
1,35	1 410 067 328	02-20-017/135
1,37	1 410 067 330	02-20-017/137
1,39	1 410 067 332	02-20-017/139
1,41	1 410 067 334	02-20-017/141
1,43	1 410 067 336	02-20-017/143
1,45	1 410 067 338	02-20-017/145

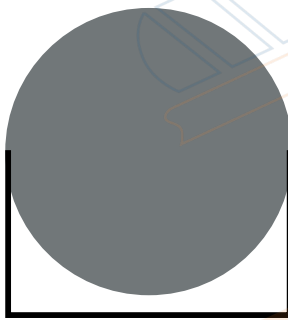

Ø9,2

da 1,00.. a 2,35
da 1,2500.. a 1,7750

ALTRE MISURE DISPONIBILI A RICHIESTA
OTHER SIZES AVAILABLE UPON REQUEST
OTROS TAMAÑOS DISPONIBLES BAJO PETICIÓN
ДРУГИЕ РАЗМЕРЫ ДОСТУПНЫ ПО ЗАПРОСУ
根據要求提供其它尺寸

CODICE OMS	SPESORE	INCREMENTO	N° PEZZI
02-20-011	DA 1,00 A 1,45	0,02	240
11-23-756	DA 1,20 A 2,35	0,05	240



HANDBAG | VALIGETTA 24 POSIZIONI | POSITION

CODICE OMS	SPESORE	INCREMENTO	N° PEZZI
11-23-755	DA 1,2500 A 1,7750	0,0125	430

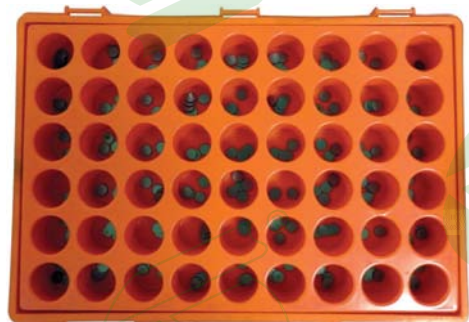

HANDBAG | VALIGETTA 54 POSIZIONI | POSITION

CODICE SINGOLI SPESSORI CODE INDIVIDUAL THICKNESSES

MISURA	COD. OMS	MISURA	COD. OMS
1,00	02-31-100	1,39	02-31-139
1,01	02-31-101	1,40	02-31-140
1,03	02-31-103	1,41	02-31-141
1,05	02-31-105	1,43	02-31-143
1,07	02-31-107	1,45	02-31-145
1,09	02-31-109	1,50	02-31-150
1,11	02-31-111	1,55	02-31-155
1,13	02-31-113	1,60	02-31-160
1,15	02-31-115	1,65	02-31-165
1,17	02-31-117	1,70	02-31-170
1,19	02-31-119	1,75	02-31-175
1,20	02-31-120	1,80	02-31-180
1,21	02-31-121	1,85	02-31-185
1,23	02-31-123	1,90	02-31-190
1,25	02-31-125	1,95	02-31-195
1,27	02-31-127	2,00	02-31-200
1,29	02-31-129	2,05	02-31-205
1,30	02-31-130	2,10	02-31-210
1,31	02-31-131	2,15	02-31-215
1,33	02-31-133	2,20	02-31-220
1,35	02-31-135	2,25	02-31-225
1,37	02-31-137	2,30	02-31-230
		2,35	02-31-235

CODICE SINGOLI SPESSORI CODE INDIVIDUAL THICKNESSES

MISURA	RIF. ORIGINALE	COD. OMS	MISURA	RIF. ORIGINALE	COD. OMS
1,2500	-	11-23-755/12500	1,5250	1 410 067 821	11-23-755/15250
1,2625	-	11-23-755/12625	1,5375	1 410 067 419	11-23-755/15375
1,2750	-	11-23-755/12750	1,5500	1 410 067 822	11-23-755/15500
1,2875	1 410 067 409	11-23-755/12875	1,5625	1 410 067 420	11-23-755/15625
1,3000	1 410 067 812	11-23-755/13000	1,5750	1 410 067 823	11-23-755/15750
1,3125	1 410 067 410	11-23-755/13125	1,5875	1 410 067 421	11-23-755/15875
1,3250	1 410 067 813	11-23-755/13250	1,6000	1 410 067 824	11-23-755/16000
1,3375	1 410 067 411	11-23-755/13375	1,6125	1 410 067 422	11-23-755/16125
1,3500	1 410 067 814	11-23-755/13500	1,6250	1 410 067 825	11-23-755/16250
1,3625	1 410 067 412	11-23-755/13625	1,6375	1 410 067 423	11-23-755/16375
1,3750	1 410 067 815	11-23-755/13750	1,6500	1 410 067 826	11-23-755/16500
1,3875	1 410 067 413	11-23-755/13875	1,6625	1 410 067 424	11-23-755/16625
1,4000	1 410 067 816	11-23-755/14000	1,6750	1 410 067 827	11-23-755/16750
1,4125	1 410 067 414	11-23-755/14125	1,6875	1 410 067 425	11-23-755/16875
1,4250	1 410 067 817	11-23-755/14250	1,7000	1 410 067 828	11-23-755/17000
1,4375	1 410 067 415	11-23-755/14375	1,7125	1 410 067 426	11-23-755/17125
1,4500	1 410 067 818	11-23-755/14500	1,7250	1 410 067 829	11-23-755/17250
1,4625	1 410 067 416	11-23-755/14625	1,7375	1 410 067 427	11-23-755/17375
1,4750	1 410 067 819	11-23-755/14750	1,7500	-	11-23-755/17500
1,4875	1 410 067 417	11-23-755/14875	1,7625	-	11-23-755/17625
1,5000	1 410 067 820	11-23-755/15000	1,7750	-	11-23-755/17750
1,5125	1 410 067 418	11-23-755/15125			

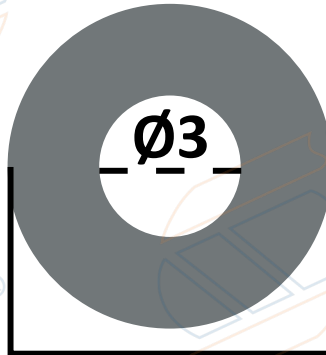
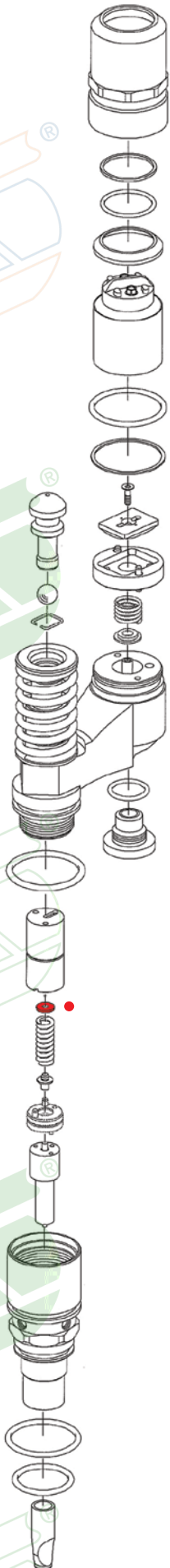

Ø8,5

da 1,10... a 1,70

ALTRE MISURE DISPONIBILI A RICHIESTA
 OTHER SIZES AVAILABLE UPON REQUEST
 OTROS TAMAÑOS DISPONIBLES BAJO PETICIÓN
 ДРУГИЕ РАЗМЕРЫ ДОСТУПНЫ ПО ЗАПРОСУ
 根據要求提供其它尺寸

TABELLA CODICI ORIGINALI
ORIGINAL CODES TABLE

MISURA	RIF. ORIGINALE 1	RIF. ORIGINALE 2	RIF. ORIGINALE 3	COD. OMS
1,10	2 430 101 805	2 430 102 310	-	02-16-007
1,12	2 430 101 806	2 430 102 312	-	02-16-043
1,14	2 430 101 807	2 430 102 314	-	02-16-044
1,16	2 430 101 808	2 430 102 316	-	02-16-045
1,18	2 430 101 809	2 430 102 318	-	02-16-046
1,20	2 430 101 810	2 430 102 320	F 00H 410 568	02-16-009
1,22	2 430 101 811	2 430 102 322	F 00H 410 569	02-16-047
1,24	2 430 101 812	2 430 102 324	F 00H 410 570	02-16-048
1,26	2 430 101 813	2 430 102 326	F 00H 410 571	02-16-049
1,28	2 430 101 814	2 430 102 328	F 00H 410 572	02-16-050
1,30	2 430 101 815	2 430 102 330	F 00H 410 573	02-16-011
1,32	2 430 101 816	2 430 102 332	F 00H 410 574	02-16-051
1,34	2 430 101 817	2 430 102 334	F 00H 410 575	02-16-052
1,36	2 430 101 822	2 430 102 344	F 00H 410 576	02-16-056
1,38	2 430 101 822	2 430 102 344	F 00H 410 577	02-16-056
1,40	2 430 101 822	2 430 102 344	F 00H 410 578	02-16-056
1,42	2 430 101 822	2 430 102 344	F 00H 410 579	02-16-056
1,44	2 430 101 822	2 430 102 344	F 00H 410 580	02-16-056
1,46	2 430 101 823	2 430 102 346	F 00H 410 581	02-16-057
1,48	2 430 101 824	2 430 102 348	F 00H 410 582	02-16-058
1,50	2 430 101 825	2 430 102 350	F 00H 410 583	02-16-015
1,52	2 430 101 826	2 430 102 352	F 00H 410 584	02-16-059
1,54	2 430 101 827	2 430 102 354	F 00H 410 585	02-16-060
1,56	2 430 101 828	2 430 102 356	F 00H 410 586	02-16-061
1,58	2 430 101 829	2 430 102 358	F 00H 410 587	02-16-062
1,60	2 430 101 830	2 430 102 360	-	02-16-017
1,62	2 430 101 831	2 430 102 362	-	02-16-063
1,64	2 430 101 832	2 430 102 364	-	02-16-064
1,66	2 430 101 833	2 430 102 366	-	02-16-065
1,68	2 430 101 834	2 430 102 368	-	02-16-066
1,70	2 430 101 835	2 430 102 370	-	02-16-019



BOSCH E VARI

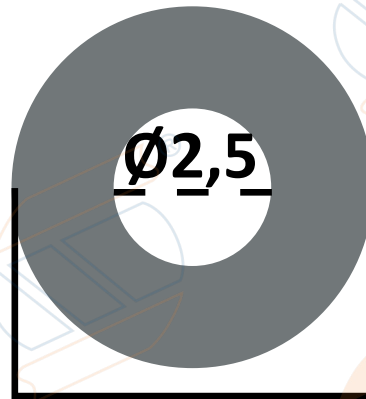

Ø7

da 0,80.. a 2,00

ALTRE MISURE DISPONIBILI A RICHIESTA
 OTHER SIZES AVAILABLE UPON REQUEST
 OTROS TAMAÑOS DISPONIBLES BAJO PETICIÓN
 ДРУГИЕ РАЗМЕРЫ ДОСТУПНЫ ПО ЗАПРОСУ
 根據要求提供其它尺寸

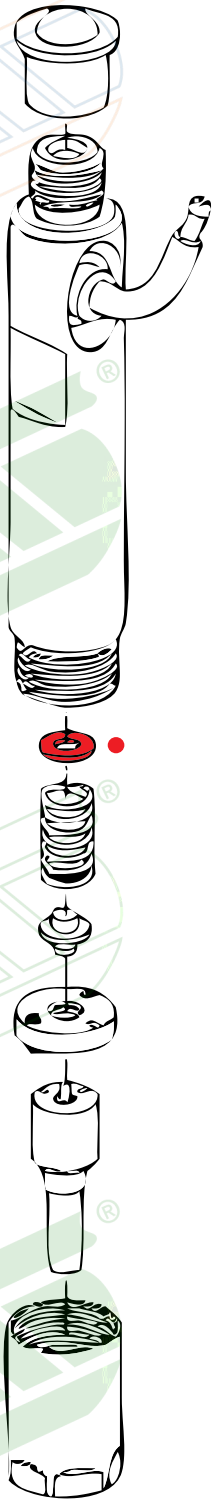

CODICE OMS	SPESSORE	INCREMENTO	N° PEZZI
02-20-007	DA 0,80 A 1,95	0,05	480

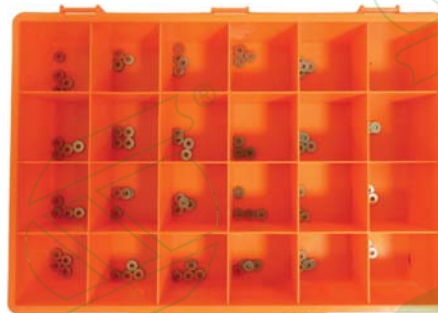

HANDBAG | VALIGETTA 24 POSIZIONI | POSITION

CODICE OMS	SPESSORE	INCREMENTO	N° PEZZI
02-20-019	DA 0,80 A 2,00	0,02	1220



HANDBAG | VALIGETTA 96 POSIZIONI | POSITION



BOSCH E VARI

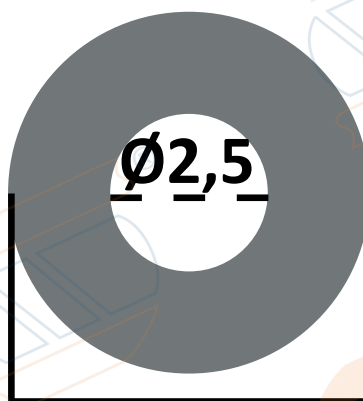

Ø7

TABELLA CODICI ORIGINALI
ORIGINAL CODES TABLE

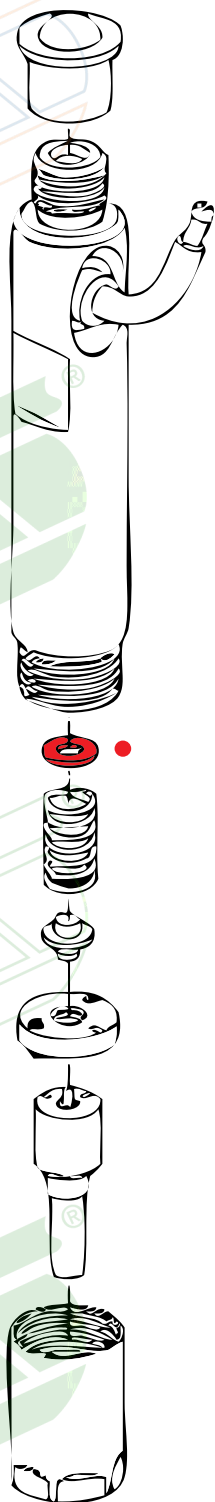

MISURA	RIF. ORIGINALE	COD. OMS	MISURA	RIF. ORIGINALE	COD. OMS
0,80	-	02-13-001	1,42	2 430 102 142	02-13-055
0,82	-	02-13-031	1,44	2 430 102 144	02-13-056
0,84	-	02-13-032	1,45	2 430 102 145	02-13-014
0,85	-	02-13-002	1,46	2 430 102 146	02-13-057
0,86	-	02-13-033	1,48	2 430 102 148	02-13-058
0,88	-	02-13-034	1,50	2 430 102 150	02-13-015
0,90	-	02-13-003	1,52	2 430 102 152	02-13-059
0,92	-	02-13-035	1,54	2 430 102 154	02-13-060
0,94	-	02-13-036	1,55	2 430 102 155	02-13-016
0,95	-	02-13-004	1,56	2 430 102 156	02-13-061
0,96	-	02-13-037	1,58	2 430 102 158	02-13-062
0,98	-	02-13-038	1,60	2 430 102 160	02-13-017
1,00	2 430 102 100	02-13-005	1,62	2 430 102 162	02-13-063
1,02	2 430 102 102	02-13-039	1,64	2 430 102 164	02-13-064
1,04	2 430 102 104	02-13-040	1,65	2 430 102 165	02-13-018
1,05	2 430 102 105	02-13-006	1,66	2 430 102 166	02-13-065
1,06	2 430 102 106	02-13-041	1,68	2 430 102 168	02-13-066
1,08	2 430 102 108	02-13-042	1,70	2 430 102 170	02-13-019
1,10	2 430 102 110	02-13-007	1,72	2 430 102 172	02-13-067
1,12	2 430 102 112	02-13-043	1,74	2 430 102 174	02-13-068
1,14	2 430 102 114	02-13-044	1,75	2 430 102 175	02-13-020
1,15	2 430 102 115	02-13-008	1,76	2 430 102 176	02-13-069
1,16	2 430 102 116	02-13-045	1,78	2 430 102 178	02-13-070
1,18	2 430 102 118	02-13-046	1,80	2 430 102 180	02-13-021
1,20	2 430 102 120	02-13-009	1,82	2 430 102 182	02-13-071
1,22	2 430 102 122	02-13-047	1,84	2 430 102 184	02-13-072
1,24	2 430 102 124	02-13-048	1,85	2 430 102 185	02-13-022
1,25	2 430 102 125	02-13-010	1,86	2 430 102 186	02-13-073
1,26	2 430 102 126	02-13-049	1,88	2 430 102 188	02-13-074
1,28	2 430 102 128	02-13-050	1,90	2 430 102 190	02-13-023
1,30	2 430 102 130	02-13-011	1,92	2 430 102 192	02-13-075
1,32	2 430 102 132	02-13-051	1,94	2 430 102 194	02-13-076
1,34	2 430 102 134	02-13-052	1,95	2 430 102 195	02-13-024
1,35	2 430 102 135	02-13-012	1,96	2 430 102 196	02-13-077
1,36	2 430 102 136	02-13-053	1,98	2 430 102 198	02-13-078
1,38	2 430 102 138	02-13-054	2,00	-	02-13-025
1,40	2 430 102 140	02-13-013			



BOSCH E VARI

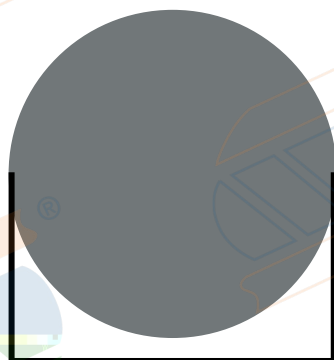
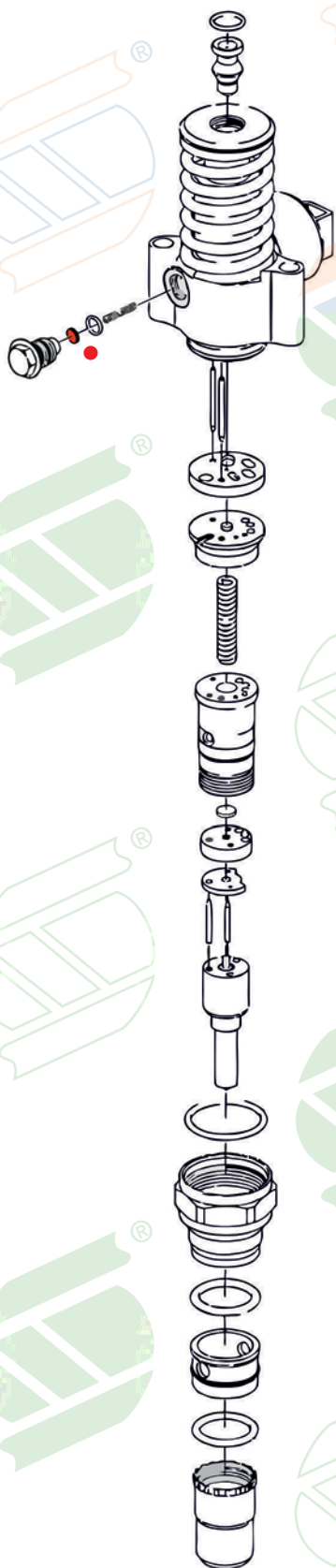

Ø4,6

da 1,00.. a 2,35

ALTRE MISURE DISPONIBILI A RICHIESTA
OTHER SIZES AVAILABLE UPON REQUEST
OTROS TAMAÑOS DISPONIBLES BAJO PETICIÓN
ДРУГИЕ РАЗМЕРЫ ДОСТУПНЫ ПО ЗАПРОСУ
根據要求提供其它尺寸

CODICE SINGOLI SPESSORI CODE INDIVIDUAL THICKNESSES	
MISURA	COD. OMS
1,00	02-20-028/100
1,01	02-20-028/101
1,03	02-20-028/103
1,05	02-20-028/105
1,07	02-20-028/107
1,09	02-20-028/109
1,11	02-20-028/111
1,13	02-20-028/113
1,15	02-20-028/115
1,17	02-20-028/117
1,19	02-20-028/119
1,21	02-20-028/121
1,23	02-20-028/123
1,25	02-20-028/125
1,27	02-20-028/127
1,29	02-20-028/129
1,31	02-20-028/131
1,33	02-20-028/133
1,35	02-20-028/135
1,37	02-20-028/137
1,39	02-20-028/139
1,41	02-20-028/141
1,43	02-20-028/143
1,45	02-20-028/145

CODICE OMS	SPESSORE	INCREMENTO	N° PEZZI
02-20-028	DA 1,00 A 1,45	0,02	240
02-20-029	DA 1,20 A 2,35	0,05	240



HANDBAG | VALIGETTA 24 POSIZIONI | POSITION

CODICE SINGOLI SPESSORI CODE INDIVIDUAL THICKNESSES			
MISURA	COD. OMS	MISURA	COD. OMS
1,20	02-20-028/120	1,80	02-20-028/180
1,25	02-20-028/125	1,85	02-20-028/185
1,30	02-20-028/130	1,90	02-20-028/190
1,35	02-20-028/135	1,95	02-20-028/195
1,40	02-20-028/140	2,00	02-20-028/200
1,45	02-20-028/145	2,05	02-20-028/205
1,50	02-20-028/150	2,10	02-20-028/210
1,55	02-20-028/155	2,15	02-20-028/215
1,60	02-20-028/160	2,20	02-20-028/220
1,65	02-20-028/165	2,25	02-20-028/225
1,70	02-20-028/170	2,30	02-20-028/230
1,75	02-20-028/175	2,35	02-20-028/235



BOSCH DOPPIA MOLLA (DOUBLE SPRING)

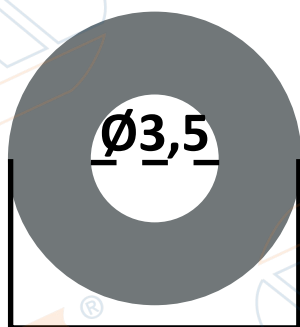

Ø7

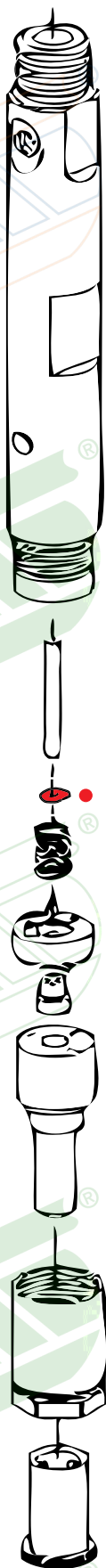

da 0,10.. a 2,00
 ALTRE MISURE DISPONIBILI A RICHIESTA
 OTHER SIZES AVAILABLE UPON REQUEST
 OTROS TAMAÑOS DISPONIBLES BAJO PETICIÓN
 ДРУГИЕ РАЗМЕРЫ ДОСТУПНЫ ПО ЗАПРОСУ
 根據要求提供其它尺寸

CODICE SINGOLI SPessori CODE INDIVIDUAL THICKNESSES			
MISURA	COD. OMS	MISURA	COD. OMS
0,10	02-14-027	1,36	02-14-053
0,20	02-14-028	1,38	02-14-054
0,30	02-14-029	1,40	02-14-013
0,40	02-14-084	1,42	02-14-055
0,50	02-14-030	1,44	02-14-056
0,80	02-14-001	1,45	02-14-014
0,82	02-14-031	1,46	02-14-057
0,84	02-14-032	1,48	02-14-058
0,85	02-14-002	1,50	02-14-015
0,86	02-14-033	1,52	02-14-059
0,88	02-14-034	1,54	02-14-060
0,90	02-14-003	1,55	02-14-016
0,92	02-14-035	1,56	02-14-061
0,94	02-14-036	1,58	02-14-062
0,95	02-14-004	1,60	02-14-017
0,96	02-14-037	1,62	02-14-063
0,98	02-14-038	1,64	02-14-064
1,00	02-14-005	1,65	02-14-018
1,02	02-14-039	1,66	02-14-065
1,04	02-14-040	1,68	02-14-066
1,05	02-14-006	1,70	02-14-019
1,06	02-14-041	1,72	02-14-067
1,08	02-14-042	1,74	02-14-068
1,10	02-14-007	1,75	02-14-020
1,12	02-14-043	1,76	02-14-069
1,14	02-14-044	1,78	02-14-070
1,15	02-14-008	1,80	02-14-021
1,16	02-14-045	1,82	02-14-071
1,18	02-14-046	1,84	02-14-072
1,20	02-14-009	1,85	02-14-022
1,22	02-14-047	1,86	02-14-073
1,24	02-14-048	1,88	02-14-074
1,25	02-14-010	1,90	02-14-023
1,26	02-14-049	1,92	02-14-075
1,28	02-14-050	1,94	02-14-076
1,30	02-14-011	1,95	02-14-024
1,32	02-14-051	1,96	02-14-077
1,34	02-14-052	1,98	02-14-078
1,35	02-14-012	2,00	02-14-025

CODICE OMS	SPessore	INCREMENTO	N° PEZZI
02-20-006	DA 0,80 A 1,95	0,05	480

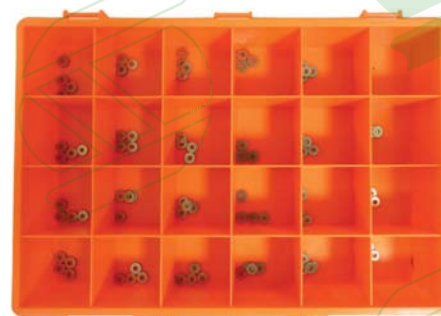

HANDBAG | VALIGETTA 24 POSIZIONI | POSITION

CODICE OMS	SPessore	INCREMENTO	N° PEZZI
02-20-020	DA 0,80 A 2,00	0,02	1220



HANDBAG | VALIGETTA 96 POSIZIONI | POSITION



BOSCH E VARI

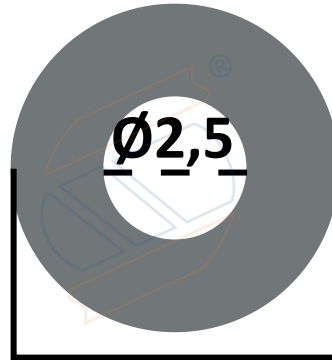
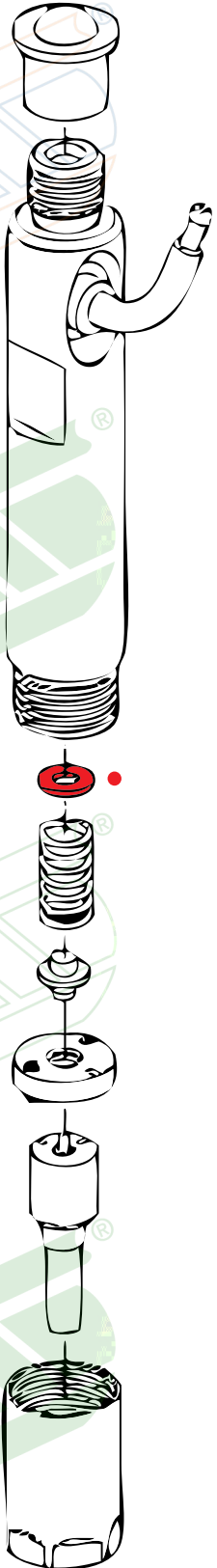

Ø7,35

da 0,05.. a 2,00
 ALTRE MISURE DISPONIBILI A RICHIESTA
 OTHER SIZES AVAILABLE UPON REQUEST
 OTROS TAMAÑOS DISPONIBLES BAJO PETICIÓN
 ДРУГИЕ РАЗМЕРЫ ДОСТУПНЫ ПО ЗАПРОСУ
 根據要求提供其它尺寸

CODICE OMS	SPESORE	INCREMENTO	N° PEZZI
02-20-005	DA 0,80 A 1,95	0,05	480

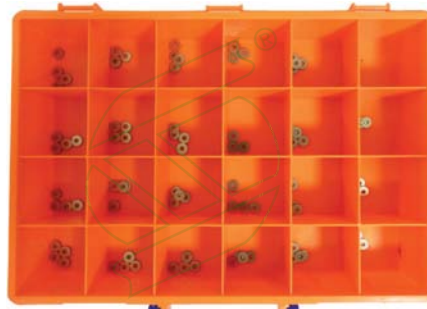

HANDBAG | VALIGETTA 24 POSIZIONI | POSITION

CODICE OMS	SPESORE	INCREMENTO	N° PEZZI
02-20-021	DA 0,80 A 2,00	0,02	1220



HANDBAG | VALIGETTA 96 POSIZIONI | POSITION



BOSCH E VARI

**TABELLA CODICI ORIGINALI
ORIGINAL CODES TABLE**

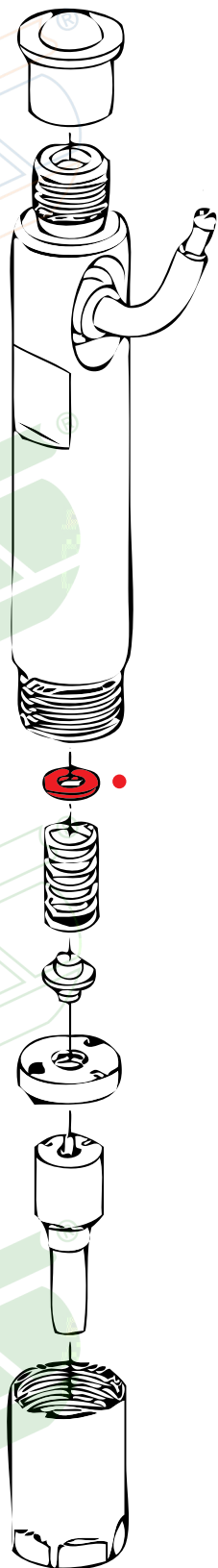

MISURA	RIF. ORIGINALE	COD. OMS	MISURA	RIF. ORIGINALE	COD. OMS
0,05	-	02-15-026	1,48	2 430 101 059	02-15-058
0,10	-	02-15-027	1,50	2 430 102 448	02-15-015
0,20	-	02-15-028	1,52	2 430 101 060	02-15-059
0,30	-	02-15-029	1,54	2 430 102 450	02-15-060
0,50	-	02-15-030	1,55	2 430 101 061	02-15-016
0,80	-	02-15-001	1,56	2 430 102 452	02-15-061
0,85	-	02-15-002	1,58	2 430 101 062	02-15-062
0,90	-	02-15-003	1,60	2 430 102 454	02-15-017
0,95	-	02-15-004	1,62	-	02-15-063
1,00	2 430 102 400	02-15-005	1,64	2 430 101 063	02-15-064
1,02	2 430 101 036	02-15-039	1,65	2 430 102 456	02-15-018
	2 430 102 402		1,66	2 430 101 064	02-15-065
1,04	2 430 101 037	02-15-040	1,68	2 430 102 458	02-15-066
	2 430 102 404		1,70	2 430 101 065	02-15-019
1,06	2 430 101 038	02-15-041	1,72	2 430 102 460	02-15-067
	2 430 102 406		1,74	2 430 101 066	02-15-068
1,08	2 430 101 039	02-15-042	1,75	2 430 102 462	02-15-020
	2 430 102 408		1,76	2 430 101 067	02-15-069
1,10	2 430 101 040	02-15-007	1,78	2 430 102 464	02-15-070
	2 430 102 410		1,80	2 430 101 067	02-15-021
1,12	2 430 101 041	02-15-043	1,82	2 430 102 464	02-15-071
	2 430 102 412		1,84	2 430 101 068	02-15-072
1,14	2 430 101 042	02-15-044	1,86	2 430 102 466	02-15-073
	2 430 102 414		1,88	2 430 101 069	02-15-074
1,16	2 430 101 043	02-15-045	1,90	2 430 102 468	02-15-075
	2 430 102 416		1,92	2 430 101 070	02-15-076
1,18	2 430 101 044	02-15-046	1,94	2 430 102 470	02-15-023
	2 430 102 418		1,96	2 430 101 071	02-15-077
1,20	2 430 101 045	02-15-009	1,98	2 430 102 472	02-15-078
	2 430 102 420		2,00	2 430 101 072	02-15-025
1,22	2 430 101 046	02-15-047		2 430 102 474	
	2 430 102 422			-	
1,24	2 430 101 047	02-15-048		2 430 101 073	
	2 430 102 424			2 430 102 476	
1,26	2 430 101 048	02-15-049		2 430 101 074	
	2 430 102 426			2 430 102 478	
1,28	2 430 101 049	02-15-050		2 430 101 075	
	2 430 102 428			2 430 102 480	
1,30	2 430 101 050	02-15-011		2 430 101 076	
	2 430 102 430			2 430 102 482	
1,32	2 430 101 051	02-15-051		2 430 101 077	
	2 430 102 432			2 430 102 484	
1,34	2 430 101 052	02-15-052		2 430 101 078	
	2 430 102 434			2 430 102 486	
1,35	-	02-15-012		2 430 101 079	
1,36	2 430 101 053	02-15-053		2 430 102 488	
	2 430 102 436			2 430 101 080	
1,38	2 430 101 054	02-15-054		2 430 102 490	
	2 430 102 438			2 430 101 081	
1,40	2 430 101 055	02-15-013		2 430 102 492	
	2 430 102 440			2 430 101 082	
1,42	2 430 101 056	02-15-055		2 430 102 494	
	2 430 102 442			-	
1,44	2 430 101 057	02-15-056		2 430 101 083	
	2 430 102 444			2 430 102 496	
1,45	-	02-15-014		2 430 101 079	
1,46	2 430 101 058	02-15-057		2 430 102 498	
	2 430 102 446			-	



BOSCH E VARI

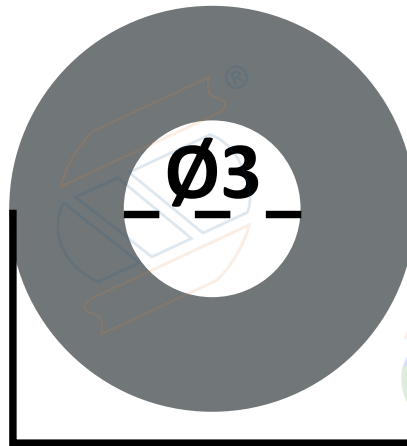

Ø8,5

CODICE OMS	SPESSORE	INCREMENTO	N° PEZZI
02-20-004	da 0,80 a 1,95	0,05	480

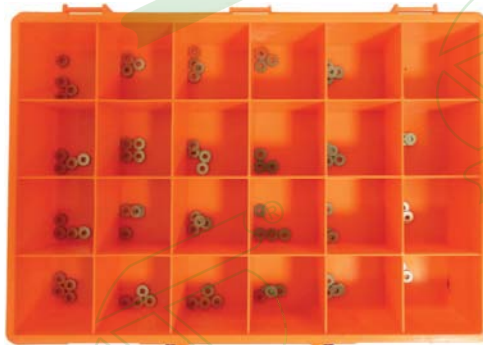

HANDBAG | VALIGETTA 24 POSIZIONI | POSITION

CODICE OMS	SPESSORE	INCREMENTO	N° PEZZI
02-20-022	DA 0,80 A 2,00	0,02	1220



HANDBAG | VALIGETTA 96 POSIZIONI | POSITION



BOSCH E VARI

TABELLA CODICI ORIGINALI ORIGINAL CODES TABLE

MISURA	RIF. ORIG. 1	RIF. ORIG. 2	RIF. ORIG. 3	COD. OMS	MISURA	RIF. ORIG. 1	RIF. ORIG. 2	RIF. ORIG. 3	COD. OMS
0,05	-	-	-	02-16-026	1,44	2 430 101 822	2 430 102 344	F 00H 410 580	02-16-056
0,10	-	-	-	02-16-027	1,45	-	-	-	02-16-014
0,20	-	-	-	02-16-028	1,46	2 430 101 823	2 430 102 346	F 00H 410 581	02-16-057
0,30	-	-	-	02-16-029	1,48	2 430 101 824	2 430 102 348	F 00H 410 582	02-16-058
0,50	-	-	-	02-16-030	1,50	2 430 101 825	2 430 102 350	F 00H 410 583	02-16-015
0,80	-	-	-	02-16-001	1,52	2 430 101 826	2 430 102 352	F 00H 410 584	02-16-059
0,85	-	-	-	02-16-002	1,54	2 430 101 827	2 430 102 354	F 00H 410 585	02-16-060
0,90	-	-	-	02-16-003	1,55	-	-	-	02-16-016
0,95	-	-	-	02-16-004	1,56	2 430 101 828	2 430 102 356	F 00H 410 586	02-16-061
1,00	2 430 101 800	2 430 102 300	-	02-16-005	1,58	2 430 101 829	2 430 102 358	F 00H 410 587	02-16-062
1,02	2 430 101 801	2 430 102 302	-	02-16-039	1,60	2 430 101 830	2 430 102 360	-	02-16-017
1,04	2 430 101 802	2 430 102 304	-	02-16-040	1,62	2 430 101 831	2 430 102 362	-	02-16-063
1,05	-	-	-	02-16-006	1,64	2 430 101 832	2 430 102 364	-	02-16-064
1,06	2 430 101 803	2 430 102 306	-	02-16-041	1,65	-	-	-	02-16-018
1,08	2 430 101 804	2 430 102 308	-	02-16-042	1,66	2 430 101 833	2 430 102 366	-	02-16-065
1,10	2 430 101 805	2 430 102 310	-	02-16-007	1,68	2 430 101 834	2 430 102 368	-	02-16-066
1,12	2 430 101 806	2 430 102 312	-	02-16-043	1,70	2 430 101 835	2 430 102 370	-	02-16-019
1,14	2 430 101 807	2 430 102 314	-	02-16-044	1,72	2 430 101 836	2 430 102 372	-	02-16-067
1,15	-	-	-	02-16-008	1,74	2 430 101 837	2 430 102 374	-	02-16-068
1,16	2 430 101 808	2 430 102 316	-	02-16-045	1,75	-	-	-	02-16-020
1,18	2 430 101 809	2 430 102 318	-	02-16-046	1,76	2 430 101 838	2 430 102 376	-	02-16-069
1,20	2 430 101 810	2 430 102 320	F 00H 410 568	02-16-009	1,78	2 430 101 839	2 430 102 378	-	02-16-070
1,22	2 430 101 811	2 430 102 322	F 00H 410 569	02-16-047	1,80	2 430 101 840	2 430 102 380	-	02-16-021
1,24	2 430 101 812	2 430 102 324	F 00H 410 570	02-16-048	1,82	2 430 101 841	2 430 102 382	-	02-16-071
1,25	-	-	-	02-16-010	1,84	2 430 101 842	2 430 102 384	-	02-16-072
1,26	2 430 101 813	2 430 102 326	F 00H 410 571	02-16-049	1,85	-	-	-	02-16-022
1,28	2 430 101 814	2 430 102 328	F 00H 410 572	02-16-050	1,86	2 430 101 843	2 430 102 386	-	02-16-073
1,30	2 430 101 815	2 430 102 330	F 00H 410 573	02-16-011	1,88	2 430 101 844	2 430 102 388	-	02-16-074
1,32	2 430 101 816	2 430 102 332	F 00H 410 574	02-16-051	1,90	2 430 101 845	2 430 102 390	-	02-16-023
1,34	2 430 101 817	2 430 102 334	F 00H 410 575	02-16-052	1,92	2 430 101 846	2 430 102 392	-	02-16-075
1,35	-	-	-	02-16-012	1,94	2 430 101 847	2 430 102 394	-	02-16-076
1,36	2 430 101 818	2 430 102 336	F 00H 410 576	02-16-053	1,95	-	-	-	02-16-024
1,38	2 430 101 819	2 430 102 338	F 00H 410 577	02-16-054	1,96	2 430 101 848	2 430 102 396	-	02-16-077
1,40	2 430 101 820	2 430 102 340	F 00H 410 578	02-16-013	1,98	2 430 101 849	2 430 102 398	-	02-16-078
1,42	2 430 101 821	2 430 102 342	F 00H 410 579	02-16-055	2,00	-	-	-	02-16-025



BOSCH E VARI

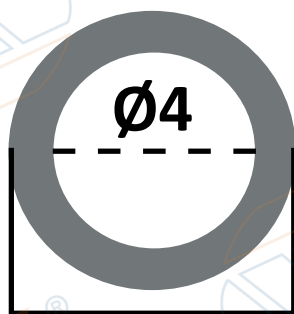

Ø9,4

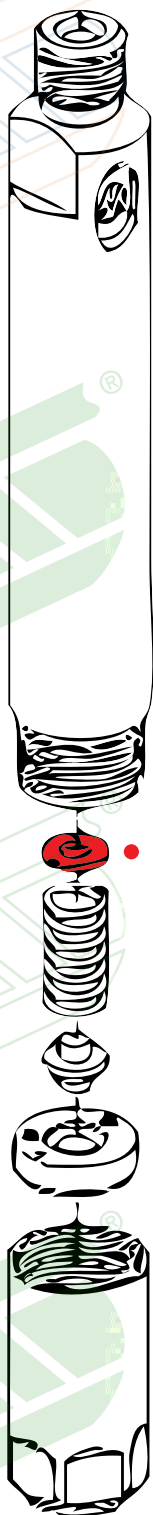

CODICE SINGOLI SPESSORI CODE INDIVIDUAL THICKNESSES

MISURA	COD. OMS	MISURA	COD. OMS
0,05	02-17-026	1,36	02-17-053
0,10	02-17-027	1,38	02-17-054
0,20	02-17-028	1,40	02-17-013
0,30	02-17-029	1,42	02-17-055
0,50	02-17-030	1,44	02-17-056
0,80	02-17-001	1,45	02-17-014
0,82	02-17-031	1,46	02-17-057
0,84	02-17-032	1,48	02-17-058
0,85	02-17-002	1,50	02-17-015
0,86	02-17-033	1,52	02-17-059
0,88	02-17-034	1,54	02-17-060
0,90	02-17-003	1,55	02-17-016
0,92	02-17-035	1,56	02-17-061
0,94	02-17-036	1,58	02-17-062
0,95	02-17-004	1,60	02-17-017
0,96	02-17-037	1,62	02-17-063
0,98	02-17-038	1,64	02-17-064
1,00	02-17-005	1,65	02-17-018
1,02	02-17-039	1,66	02-17-065
1,04	02-17-040	1,68	02-17-066
1,05	02-17-006	1,70	02-17-019
1,06	02-17-041	1,72	02-17-067
1,08	02-17-042	1,74	02-17-068
1,10	02-17-007	1,75	02-17-020
1,12	02-17-043	1,76	02-17-069
1,14	02-17-044	1,78	02-17-070
1,15	02-17-008	1,80	02-17-021
1,16	02-17-045	1,82	02-17-071
1,18	02-17-046	1,84	02-17-072
1,20	02-17-009	1,85	02-17-022
1,22	02-17-047	1,86	02-17-073
1,24	02-17-048	1,88	02-17-074
1,25	02-17-010	1,90	02-17-023
1,26	02-17-049	1,92	02-17-075
1,28	02-17-050	1,94	02-17-076
1,30	02-17-011	1,95	02-17-024
1,32	02-17-051	1,96	02-17-077
1,34	02-17-052	1,98	02-17-078
1,35	02-17-012	2,00	02-17-025

da 0,05.. a 2,00

ALTRE MISURE DISPONIBILI A RICHIESTA
OTHER SIZES AVAILABLE UPON REQUEST
OTROS TAMAÑOS DISPONIBLES BAJO PETICIÓN
ДРУГИЕ РАЗМЕРЫ ДОСТУПНЫ ПО ЗАПРОСУ
根據要求提供其它尺寸

CODICE OMS	SPESSORE	INCREMENTO	N° PEZZI
02-20-003	da 0,80 a 1,95	0,05	480

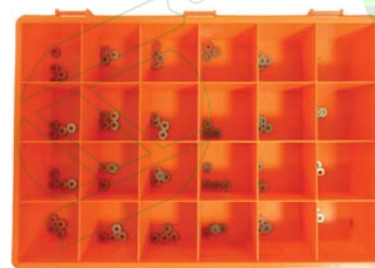

HANDBAG | VALIGETTA 24 POSIZIONI | POSITION

CODICE OMS	SPESSORE	INCREMENTO	N° PEZZI
02-20-023	da 0,80 a 2,00	0,02	1220



HANDBAG | VALIGETTA 96 POSIZIONI | POSITION



BOSCH E VARI

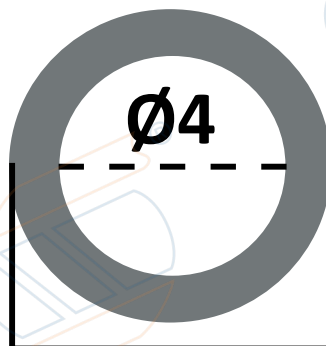

Ø9,8

da 0,05.. a 2,00

ALTRE MISURE DISPONIBILI A RICHIESTA
OTHER SIZES AVAILABLE UPON REQUEST
OTROS TAMAÑOS DISPONIBLES BAJO PETICIÓN
ДРУГИЕ РАЗМЕРЫ ДОСТУПНЫ ПО ЗАПРОСУ
根據要求提供其它尺寸

CODICE OMS	SPESSORE	INCREMENTO	N° PEZZI
02-20-002	DA 0,80 A 1,95	0,05	480

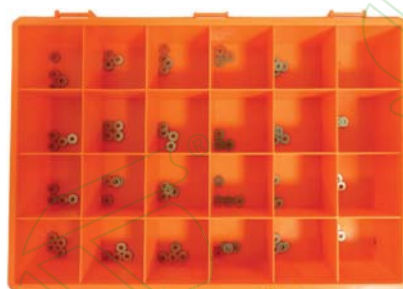

HANDBAG | VALIGETTA 24 POSIZIONI | POSITION

CODICE OMS	SPESSORE	INCREMENTO	N° PEZZI
02-20-024	DA 0,80 A 2,00	0,02	1220



HANDBAG | VALIGETTA 96 POSIZIONI | POSITION

Misure a Seguire



BOSCH E VARI

**TABELLA CODICI ORIGINALI
ORIGINAL CODES TABLE**



MISURA	RIF. ORIGINALE	COD. OMS	MISURA	RIF. ORIGINALE	COD. OMS
0,05	-	02-18-026			
0,10	-	02-18-027	1,34	2 430 101 527	02-18-052
0,20	-	02-18-028	1,35	-	02-18-012
0,30	-	02-18-029		2 430 101 528	
0,50	-	02-18-030	1,36	2 430 101 188	02-18-053
	2 430 101 500			2 430 101 529	
0,80	2 430 101 680	02-18-001	1,38	2 430 101 189	02-18-054
	2 430 101 501			2 430 101 530	
0,82	2 430 101 682	02-18-031	1,40	2 430 101 190	02-18-013
0,84	2 430 101 502	02-18-032	1,42	2 430 101 531	02-18-055
0,85	-	02-18-002		2 430 101 532	
	2 430 101 503		1,44	2 430 101 192	02-18-056
0,86	2 430 101 686	02-18-033	1,45	-	02-18-014
	2 430 101 504		1,46	2 430 101 533	02-18-057
0,88	2 430 101 688	02-18-034	1,48	2 430 101 534	02-18-058
0,90	2 430 101 505	02-18-003		2 430 101 535	
	2 430 101 506		1,50	2 430 101 195	02-18-015
0,92	2 430 101 692	02-18-035	1,52	2 430 101 536	02-18-059
0,94	2 430 101 507	02-18-036	1,54	2 430 101 537	02-18-060
0,95	-	02-18-004	1,55	-	02-18-016
0,96	2 430 101 508	02-18-037		2 430 101 538	
0,98	2 430 101 509	02-18-038	1,56	2 430 101 198	02-18-061
	2 430 101 510			2 430 101 539	
1,00	2 430 101 170	02-18-005	1,58	2 430 101 199	02-18-062
	2 430 101 511		1,60	2 430 101 540	02-18-017
1,02	2 430 101 171	02-18-039	1,62	2 430 101 541	02-18-063
	2 430 101 512			2 430 101 542	
1,04	2 430 101 172	02-18-040	1,64	2 430 101 202	02-18-064
1,05	-	02-18-006	1,65	-	02-18-018
	2 430 101 513		1,66	2 430 101 543	02-18-065
1,06	2 430 101 173	02-18-041		2 430 101 544	
	2 430 101 514		1,68	2 430 101 204	02-18-066
1,08	2 430 101 174	02-18-042	1,70	2 430 101 545	02-18-019
	2 430 101 515			2 430 101 546	
1,10	2 430 101 175	02-18-007	1,72	2 430 101 206	02-18-067
	2 430 101 516		1,74	2 430 101 547	02-18-068
1,12	2 430 101 176	02-18-043	1,75	-	02-18-020
	2 430 101 517		1,76	2 430 101 548	02-18-069
1,14	2 430 101 177	02-18-044		2 430 101 549	
	-	02-18-008	1,78	2 430 101 209	02-18-070
1,16	2 430 101 518			2 430 101 550	
	2 430 101 178	02-18-045	1,80	2 430 101 210	02-18-021
	2 430 101 519		1,82	2 430 101 551	02-18-071
1,18	2 430 101 179	02-18-046		2 430 101 211	
	2 430 101 520		1,84	2 430 101 552	02-18-072
1,20	2 430 101 180	02-18-009		2 430 101 212	
	2 430 101 521		1,85	-	02-18-022
1,22	2 430 101 181	02-18-047	1,86	2 430 101 553	02-18-073
	2 430 101 722		1,88	2 430 101 554	02-18-074
	2 430 101 522		1,90	2 430 101 555	02-18-023
1,24	2 430 101 182	02-18-048		2 430 101 215	
	-	02-18-010	1,92	2 430 101 556	02-18-075
1,25			1,94	2 430 101 557	02-18-076
	2 430 101 523		1,95	-	02-18-024
1,26	2 430 101 183	02-18-049		2 430 101 558	02-18-077
	2 430 101 524		1,96	2 430 101 218	
1,28	2 430 101 184	02-18-050		2 430 101 559	02-18-078
	2 430 101 525		1,98	2 430 101 219	
1,30	2 430 101 185	02-18-011		-	02-18-025
	2 430 101 526		2,00	-	
1,32	2 430 101 186	02-18-051			



BOSCH E VARI

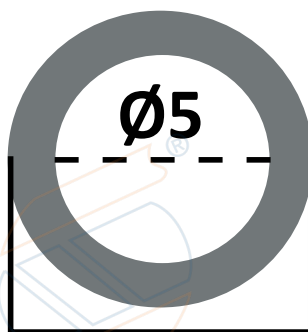
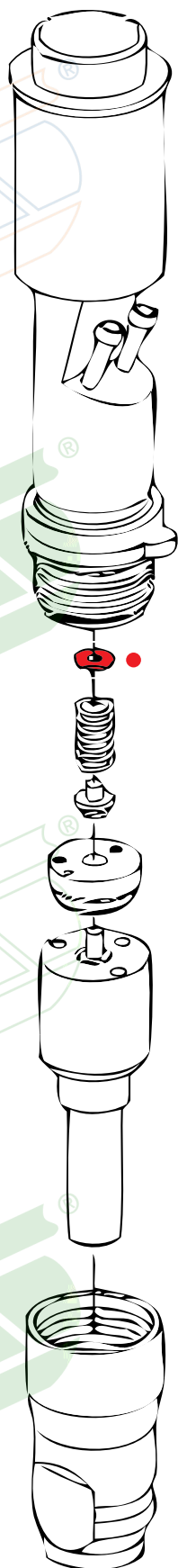

Ø11,5

da 0,05.. a 2,00

ALTRE MISURE DISPONIBILI A RICHIESTA
OTHER SIZES AVAILABLE UPON REQUEST
OTROS TAMAÑOS DISPONIBLES BAJO PETICIÓN
ДРУГИЕ РАЗМЕРЫ ДОСТУПНЫ ПО ЗАПРОСУ
根據要求提供其它尺寸

CODICE OMS	SPESORE	INCREMENTO	N° PEZZI
02-20-001	DA 0,80 A 1,95	0,05	480

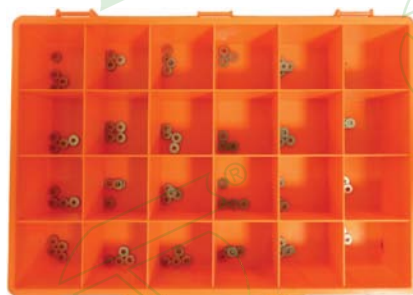

HANDBAG | VALIGETTA 24 POSIZIONI | POSITION

CODICE OMS	SPESORE	INCREMENTO	N° PEZZI
02-20-025	DA 0,80 A 2,00	0,02	1220



HANDBAG | VALIGETTA 96 POSIZIONI | POSITION

Misure a Seguire



BOSCH E VARI

TABELLA CODICI ORIGINALI
ORIGINAL CODES TABLE

MISURA	RIF. ORIGINALE	COD. OMS	MISURA	RIF. ORIGINALE	COD. OMS
0,05	-	02-19-026	1,38	2 430 102 938	02-19-054
0,10	-	02-19-027		2 430 100 554	
0,20	-	02-19-028	1,40	2 430 102 940	02-19-013
0,30	-	02-19-029		2 430 100 555	
0,50	-	02-19-030	1,42	2 430 100 556	02-19-055
0,80	2 430 100 525	02-19-001		2 430 102 942	
	2 430 102 880		1,44	2 430 102 944	02-19-056
0,82	2 430 100 526	02-19-031		2 430 100 557	
	2 430 102 882		1,45	-	02-19-014
0,84	2 430 102 884	02-19-032	1,46	2 430 102 946	02-19-057
	2 430 100 527			2 430 100 558	
0,85	-	02-19-002	1,48	2 430 102 948	02-19-058
0,86	2 430 100 528	02-19-033		2 430 100 559	
	2 430 102 886		1,50	2 430 102 950	02-19-015
0,88	2 430 102 888	02-19-034		2 430 100 560	
	2 430 100 529		1,52	2 430 102 952	02-19-059
0,90	2 430 102 890	02-19-003		2 430 100 561	
	2 430 100 530		1,54	2 430 102 954	02-19-060
0,92	2 430 102 892	02-19-035		2 430 100 562	
	2 430 100 531		1,55	-	02-19-016
0,94	2 430 100 532	02-19-036	1,56	2 430 102 956	02-19-061
	2 430 102 894			2 430 100 563	
0,95	-	02-19-004	1,58	2 430 102 958	02-19-062
0,96	2 430 102 896	02-19-037		2 430 100 564	
	2 430 100 533		1,60	2 430 102 960	02-19-017
0,98	2 430 102 898	02-19-038		2 430 100 565	
	2 430 100 534		1,62	2 430 102 962	02-19-063
1,00	2 430 102 900	02-19-005		2 430 100 566	
	2 430 100 535		1,64	2 430 102 964	02-19-064
1,02	2 430 102 902	02-19-039		2 430 100 567	
	2 430 100 536		1,65	-	02-19-018
1,04	2 430 102 904	02-19-040	1,66	2 430 102 966	02-19-065
	2 430 100 537			2 430 100 568	
1,05	-	02-19-006	1,68	2 430 102 968	02-19-066
1,06	2 430 102 906	02-19-041		2 430 100 569	
	2 430 100 538		1,70	2 430 102 970	02-19-019
1,08	2 430 102 908	02-19-042		2 430 100 570	
	2 430 100 539		1,72	2 430 102 972	02-19-067
1,10	2 430 100 540	02-19-007		2 430 100 571	
	2 430 102 910		1,74	2 430 102 974	02-19-068
1,12	2 430 102 912	02-19-043		2 430 100 572	
	2 430 100 541		1,75	-	02-19-020
1,14	2 430 102 914	02-19-044	1,76	2 430 102 976	02-19-069
	2 430 100 542			2 430 100 573	
1,15	-	02-19-008	1,78	2 430 102 978	02-19-070
1,16	2 430 102 916	02-19-045		2 430 100 574	
	2 430 100 543		1,80	2 430 102 980	02-19-021
1,18	2 430 102 918	02-19-046		2 430 100 575	
	2 430 100 544		1,82	2 430 102 982	02-19-071
1,20	2 430 102 920	02-19-009		2 430 100 576	
	2 430 100 545		1,84	2 430 102 984	02-19-072
	2 430 102 922			2 430 100 577	
1,22	2 430 100 546	02-19-047	1,85	-	02-19-022
	2 430 100 548		1,86	2 430 102 986	02-19-073
1,24	2 430 102 924	02-19-048		2 430 100 578	
	2 430 100 547		1,88	2 430 102 988	02-19-074
1,25	-	02-19-010		2 430 100 579	
1,26	2 430 102 926	02-19-049	1,90	2 430 102 990	02-19-023
	2 430 102 928			2 430 100 580	
1,28	2 430 100 549	02-19-050	1,92	2 430 102 992	02-19-075
	2 430 102 930			2 430 100 581	
1,30	2 430 100 550	02-19-011	1,94	2 430 102 994	02-19-076
	2 430 102 932			2 430 100 582	
1,32	2 430 100 551	02-19-051	1,95	-	02-19-024
	2 430 102 934		1,96	2 430 102 996	02-19-077
1,34	2 430 100 552	02-19-052		2 430 100 583	
1,35	-	02-19-012	1,98	2 430 102 998	02-19-078
	2 430 102 936			2 430 100 584	
1,36	2 430 100 553	02-19-053	2,00	-	02-19-025

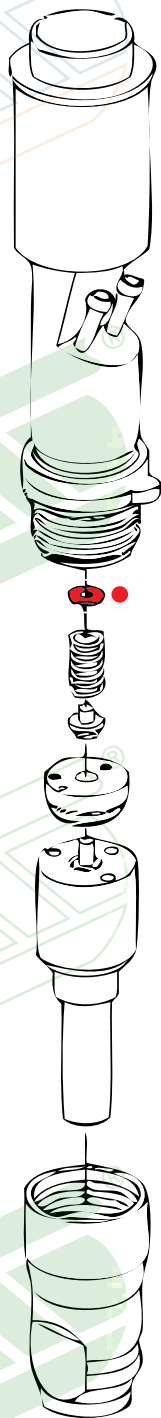



BOSCH E VARI

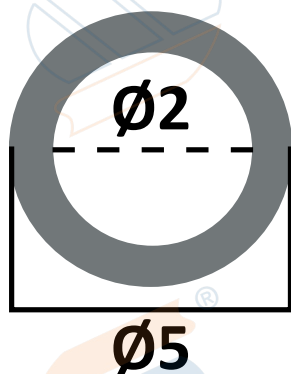

da 0,80.. a 2,00
 ALTRE MISURE DISPONIBILI A RICHIESTA
 OTHER SIZES AVAILABLE UPON REQUEST
 OTROS TAMAÑOS DISPONIBLES BAJO PETICIÓN
 ДРУГИЕ РАЗМЕРЫ ДОСТУПНЫ ПО ЗАПРОСУ
 根據要求提供其它尺寸

CODICE SINGOLI SPESSORI CODE INDIVIDUAL THICKNESSES

MISURA	COD. OMS	MISURA	COD. OMS
0,80	02-12-001	1,42	02-12-055
0,82	02-12-031	1,44	02-12-056
0,84	02-12-032	1,45	02-12-014
0,85	02-12-002	1,46	02-12-057
0,86	02-12-033	1,48	02-12-058
0,88	02-12-034	1,50	02-12-015
0,90	02-12-003	1,52	02-12-059
0,92	02-12-035	1,54	02-12-060
0,94	02-12-036	1,55	02-12-016
0,95	02-12-004	1,56	02-12-061
0,96	02-12-037	1,58	02-12-062
0,98	02-12-038	1,60	02-12-017
1,00	02-12-005	1,62	02-12-063
1,02	02-12-039	1,64	02-12-064
1,04	02-12-040	1,65	02-12-018
1,05	02-12-006	1,66	02-12-065
1,06	02-12-041	1,68	02-12-066
1,08	02-12-042	1,70	02-12-019
1,10	02-12-007	1,72	02-12-067
1,12	02-12-043	1,74	02-12-068
1,14	02-12-044	1,75	02-12-020
1,15	02-12-008	1,76	02-12-069
1,16	02-12-045	1,78	02-12-070
1,18	02-12-046	1,80	02-12-021
1,20	02-12-009	1,82	02-12-071
1,22	02-12-047	1,84	02-12-072
1,24	02-12-048	1,85	02-12-022
1,25	02-12-010	1,86	02-12-073
1,26	02-12-049	1,88	02-12-074
1,28	02-12-050	1,90	02-12-023
1,30	02-12-011	1,92	02-12-075
1,32	02-12-051	1,94	02-12-076
1,34	02-12-052	1,95	02-12-024
1,35	02-12-012	1,96	02-12-077
1,36	02-12-053	1,98	02-12-078
1,38	02-12-054	2,00	02-12-025
1,40	02-12-013		

CODICE OMS	SPESSORE	INCREMENTO	N° PEZZI
02-20-008	DA 0,80 A 1,95	0,05	480

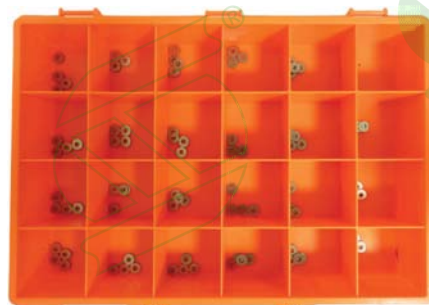

HANDBAG | VALIGETTA 24 POSIZIONI | POSITION

CODICE OMS	SPESSORE	INCREMENTO	N° PEZZI
02-20-026	DA 0,80 A 2,00	0,02	1220



HANDBAG | VALIGETTA 96 POSIZIONI | POSITION



BOSCH DOPPIA MOLLA (DOUBLE SPRING)

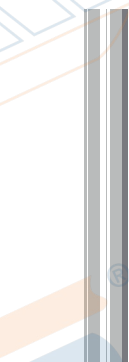
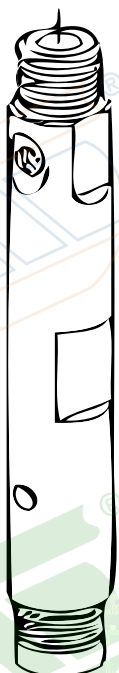

ASTA PRESSIONE
pressure pin
presión pin

da 28,19.. a 29,49

ALTRE MISURE DISPONIBILI A RICHIESTA
OTHER SIZES AVAILABLE UPON REQUEST
OTROS TAMAÑOS DISPONIBLES BAJO PETICIÓN
ДРУГИЕ РАЗМЕРЫ ДОСТУПНЫ ПО ЗАПРОСУ
根據要求提供其它尺寸

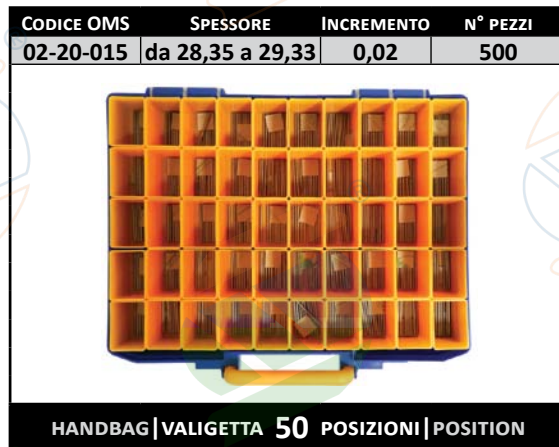

HANDBAG | VALIGETTA 50 POSIZIONI | POSITION

TABELLA CODICI ORIGINALI ORIGINAL CODES TABLE

MISURA	RIF. ORIGINALE	COD. OMS	MISURA	RIF. ORIGINALE	COD. OMS
28,19	2 433 101 580	02-27-001	28,85	2 433 101 336	02-27-034
28,21	2 433 101 578	02-27-002	28,87	2 433 101 338	02-27-035
28,23	2 433 101 576	02-27-003	28,89	2 433 101 340	02-27-036
28,25	2 433 101 574	02-27-004	28,91	2 433 101 342	02-27-037
28,27	2 433 101 572	02-27-005	28,93	2 433 101 344	02-27-038
28,29	2 433 101 570	02-27-006	28,95	2 433 101 346	02-27-039
28,31	2 433 101 568	02-27-007	28,97	2 433 101 348	02-27-040
28,33	2 433 101 566	02-27-008	28,99	2 433 101 350	02-27-041
28,35	2 433 101 564	02-27-009	29,01	2 433 101 352	02-27-042
28,37	2 433 101 562	02-27-010	29,03	2 433 101 354	02-27-043
28,39	2 433 101 560	02-27-011	29,05	2 433 101 356	02-27-044
28,41	2 433 101 558	02-27-012	29,07	2 433 101 358	02-27-045
28,43	2 433 101 556	02-27-013	29,09	2 433 101 360	02-27-046
28,45	2 433 101 554	02-27-014	29,11	2 433 101 362	02-27-047
28,47	2 433 101 552	02-27-015	29,13	2 433 101 364	02-27-048
28,49	2 433 101 550	02-27-016	29,15	2 433 101 366	02-27-049
28,51	2 433 101 302	02-27-017	29,17	2 433 101 368	02-27-050
28,53	2 433 101 304	02-27-018	29,19	2 433 101 370	02-27-051
28,55	2 433 101 306	02-27-019	29,21	2 433 101 372	02-27-052
28,57	2 433 101 308	02-27-020	29,23	2 433 101 374	02-27-053
28,59	2 433 101 310	02-27-021	29,25	2 433 101 376	02-27-054
28,61	2 433 101 312	02-27-022	29,27	2 433 101 378	02-27-055
28,63	2 433 101 314	02-27-023	29,29	2 433 101 380	02-27-056
28,65	2 433 101 316	02-27-024	29,31	2 433 101 382	02-27-057
28,67	2 433 101 318	02-27-025	29,33	2 433 101 384	02-27-058
28,69	2 433 101 320	02-27-026	29,35	2 433 101 386	02-27-059
28,71	2 433 101 322	02-27-027	29,37	2 433 101 388	02-27-060
28,73	2 433 101 324	02-27-028	29,39	2 433 101 390	02-27-061
28,75	2 433 101 326	02-27-029	29,41	2 433 101 392	02-27-062
28,77	2 433 101 328	02-27-030	29,43	2 433 101 394	02-27-063
28,79	2 433 101 330	02-27-031	29,45	2 433 101 396	02-27-064
28,81	2 433 101 332	02-27-032	29,47	2 433 101 398	02-27-065
28,83	2 433 101 334	02-27-033	29,49	2 433 101 400	02-27-066



BOSCH DOPPIA MOLLA (DOUBLE SPRING)

TABELLA CODICI ORIGINALI ORIGINAL CODES TABLE

MISURA	RIF. ORIGINALE	COD. OMS
33,80	2 433 101 200	02-26-001
33,82	2 433 101 202	02-26-002
33,84	2 433 101 204	02-26-003
33,86	2 433 101 206	02-26-004
33,88	2 433 101 208	02-26-005
33,90	2 433 101 210	02-26-006
33,92	2 433 101 212	02-26-007
33,94	2 433 101 214	02-26-008
33,96	2 433 101 216	02-26-009
33,98	2 433 101 218	02-26-010
34,00	2 433 101 220	02-26-011
34,02	2 433 101 222	02-26-012
34,04	2 433 101 224	02-26-013
34,06	2 433 101 226	02-26-014
34,08	2 433 101 228	02-26-015
34,10	2 433 101 230	02-26-016
34,12	2 433 101 232	02-26-017
34,14	2 433 101 234	02-26-018
34,16	2 433 101 236	02-26-019
34,18	2 433 101 238	02-26-020
34,20	2 433 101 240	02-26-021
34,22	2 433 101 242	02-26-022
34,24	2 433 101 244	02-26-023
34,26	2 433 101 246	02-26-024
34,28	2 433 101 248	02-26-025
34,30	2 433 101 250	02-26-026
34,32	2 433 101 252	02-26-027
34,34	2 433 101 254	02-26-028
34,36	2 433 101 256	02-26-029
34,38	2 433 101 258	02-26-030
34,40	2 433 101 260	02-26-031
34,42	2 433 101 262	02-26-032
34,44	2 433 101 264	02-26-033
34,46	2 433 101 266	02-26-034
34,48	2 433 101 268	02-26-035
34,50	2 433 101 270	02-26-036
34,52	2 433 101 272	02-26-037
34,54	2 433 101 274	02-26-038
34,56	2 433 101 276	02-26-039
34,58	2 433 101 278	02-26-040
34,60	2 433 101 280	02-26-041
34,62	2 433 101 282	02-26-042
34,64	2 433 101 284	02-26-043
34,66	2 433 101 286	02-26-044
34,68	2 433 101 288	02-26-045
34,70	2 433 101 290	02-26-046
34,72	2 433 101 292	02-26-047
34,74	2 433 101 294	02-26-048
34,76	2 433 101 296	02-26-049
34,78	2 433 101 298	02-26-050
34,80	2 433 101 300	02-26-051



ASTA PRESSIONE
pressure pin
presión pin

da 33,80.. a 34,80
 ALTRE MISURE DISPONIBILI A RICHIESTA
 OTHER SIZES AVAILABLE UPON REQUEST
 OTROS TAMAÑOS DISPONIBLES BAJO PETICIÓN
 ДРУГИЕ РАЗМЕРЫ ДОСТУПНЫ ПО ЗАПРОСУ
 根據要求提供其它尺寸

CODICE OMS	SPESORE	INCREMENTO	N° PEZZI
02-20-014	DA 33,80 A 34,78	0,02	500



HANDBAG | VALIGETTA 50 POSIZIONI | POSITION



BOSCH DOPPIA MOLLA (DOUBLE SPRING)

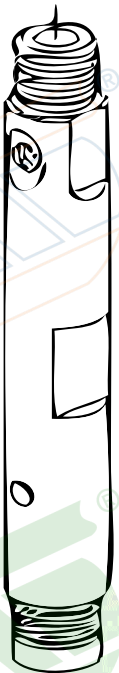

SPINA DI PRESSIONE

pressure pin
presión pin

da 43,80.. a 44,78

ALTRE MISURE DISPONIBILI A RICHIESTA

OTHER SIZES AVAILABLE UPON REQUEST

OTROS TAMAÑOS DISPONIBLES BAJO PETICIÓN

ДРУГИЕ РАЗМЕРЫ ДОСТУПНЫ ПО ЗАПРОСУ

根據要求提供其它尺寸

CODICE OMS	SPESORE	INCREMENTO	N° PEZZI
02-20-013	DA 43,80 A 44,78	0,02	500

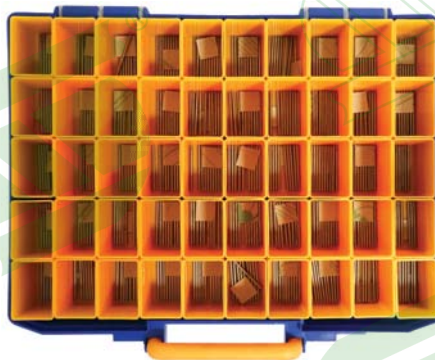

HANDBAG | VALIGETTA 50 POSIZIONI | POSITION

TABELLA CODICI ORIGINALI ORIGINAL CODES TABLE

MISURA	RIF. ORIGINALE	COD. OMS
43,80	2 433 101 100	02-25-001
43,82	2 433 101 102	02-25-002
43,84	2 433 101 104	02-25-003
43,86	2 433 101 106	02-25-004
43,88	2 433 101 108	02-25-005
43,90	2 433 101 110	02-25-006
43,92	2 433 101 112	02-25-007
43,94	2 433 101 114	02-25-008
43,96	2 433 101 116	02-25-009
43,98	2 433 101 118	02-25-010
44,00	2 433 101 120	02-25-011
44,02	2 433 101 122	02-25-012
44,04	2 433 101 124	02-25-013
44,06	2 433 101 126	02-25-014
44,08	2 433 101 128	02-25-015
44,10	2 433 101 130	02-25-016
44,12	2 433 101 132	02-25-017
44,14	2 433 101 134	02-25-018
44,16	2 433 101 136	02-25-019
44,18	2 433 101 138	02-25-020
44,20	2 433 101 140	02-25-021
44,22	2 433 101 142	02-25-022
44,24	2 433 101 144	02-25-023
44,26	2 433 101 146	02-25-024
44,28	2 433 101 148	02-25-025
44,30	2 433 101 150	02-25-026
44,32	2 433 101 152	02-25-027
44,34	2 433 101 154	02-25-028
44,36	2 433 101 156	02-25-029
44,38	2 433 101 158	02-25-030
44,40	2 433 101 160	02-25-031
44,42	2 433 101 162	02-25-032
44,44	2 433 101 164	02-25-033
44,46	2 433 101 166	02-25-034
44,48	2 433 101 168	02-25-035
44,50	2 433 101 170	02-25-036
44,52	2 433 101 172	02-25-037
44,54	2 433 101 174	02-25-038
44,56	2 433 101 176	02-25-039
44,58	2 433 101 178	02-25-040
44,60	2 433 101 180	02-25-041
44,62	2 433 101 182	02-25-042
44,64	2 433 101 184	02-25-043
44,66	2 433 101 186	02-25-044
44,68	2 433 101 188	02-25-045
44,70	2 433 101 190	02-25-046
44,72	2 433 101 192	02-25-047
44,74	2 433 101 194	02-25-048
44,76	2 433 101 196	02-25-049
44,78	2 433 101 198	02-25-050



BOSCH POMPA P



PIASTRINA COMPENSAZIONE
compensation plate
compensación de la placa

da 0,40.. a 2,50

ALTRE MISURE DISPONIBILI A RICHIESTA
OTHER SIZES AVAILABLE UPON REQUEST
OTROS TAMAÑOS DISPONIBLES BAJO PETICIÓN
ДРУГИЕ РАЗМЕРЫ ДОСТУПНЫ ПО ЗАПРОСУ
根據要求提供其它尺寸

CODICE OMS	SPESSORE	INCREMENTO	N° PEZZI
02-20-010	DA 0,40 A 2,50	0,05	430



HANDBAG | VALIGETTA 50 POSIZIONI | POSITION

TABELLA CODICI ORIGINALI ORIGINAL CODES TABLE

MISURA	RIF. ORIGINALE	COD. OMS
0,40	2 411 098 010	03-02-159
0,45	2 411 098 011	03-02-160
0,50	2 411 098 012	03-02-161
0,55	2 411 098 013	03-02-162
0,60	2 411 098 014	03-02-163
0,65	2 411 098 015	03-02-164
0,70	2 411 098 016	03-02-165
0,75	2 411 098 017	03-02-166
0,80	2 411 098 018	03-02-167
0,85	2 411 098 019	03-02-168
0,90	2 411 098 020	03-02-169
0,95	2 411 098 021	03-02-170
1,00	2 411 098 022	03-02-171
1,05	2 411 098 023	03-02-172
1,10	2 411 098 024	03-02-173
1,15	2 411 098 025	03-02-174
1,20	2 411 098 026	03-02-175
1,25	2 411 098 027	03-02-176
1,30	2 411 098 028	03-02-177
1,35	2 411 098 029	03-02-178
1,40	2 411 098 030	03-02-179
1,45	2 411 098 031	03-02-180
1,50	2 411 098 032	03-02-181
1,55	2 411 098 033	03-02-182
1,60	2 411 098 034	03-02-183
1,65	2 411 098 035	03-02-184
1,70	2 411 098 036	03-02-185
1,75	2 411 098 037	03-02-186
1,80	2 411 098 038	03-02-187
1,85	2 411 098 039	03-02-188
1,90	2 411 098 040	03-02-189
1,95	2 411 098 041	03-02-190
2,00	2 411 098 042	03-02-191
2,05	2 411 098 043	03-02-192
2,10	2 411 098 044	03-02-193
2,15	2 411 098 045	03-02-194
2,20	2 411 098 046	03-02-195
2,25	2 411 098 047	03-02-196
2,30	2 411 098 048	03-02-197
2,35	2 411 098 049	03-02-198
2,40	2 411 098 050	03-02-199
2,45	2 411 098 051	03-02-200
2,50	2 411 098 052	03-02-201

SIEMENS

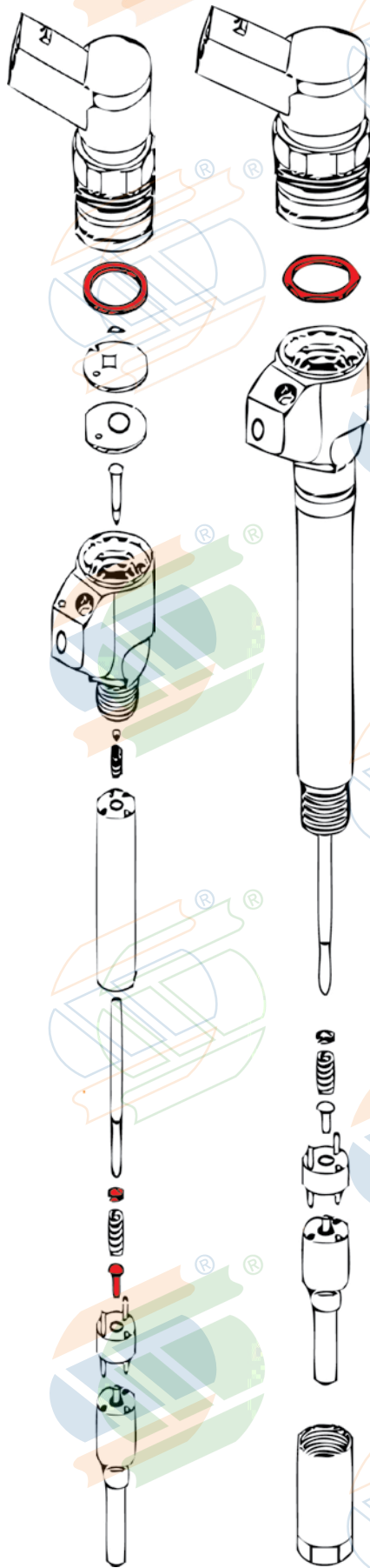



SIEMENS

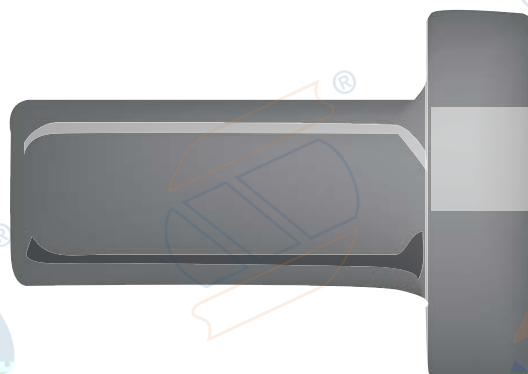
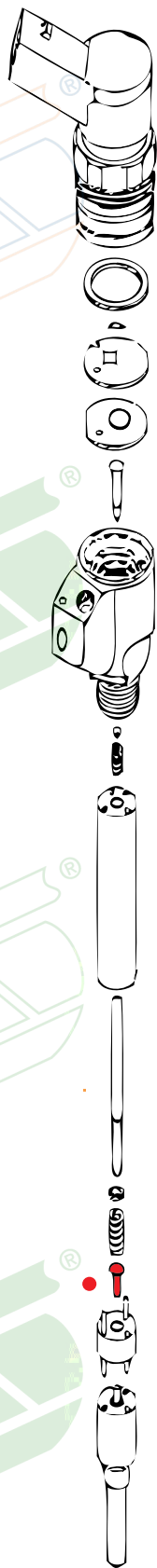

da 7,76.. a 8,18

ALTRE MISURE DISPONIBILI A RICHIESTA
OTHER SIZES AVAILABLE UPON REQUEST
OTROS TAMAÑOS DISPONIBLES BAJO PETICIÓN
ДРУГИЕ РАЗМЕРЫ ДОСТУПНЫ ПО ЗАПРОСУ
根據要求提供其它尺寸

CODICE OMS	SPESORE	INCREMENTO	N° PEZZI
11-23-342	da 7,76 a 8,18	0,02	220



VALIGETTA | HANDBAG 24 POSIZIONI | POSITION

CODICE SINGOLI SPESSORI
CODE INDIVIDUAL THICKNESSES

MISURA	COD. OMS
7,76	11-23-342/776
7,78	11-23-342/778
7,80	11-23-342/780
7,82	11-23-342/782
7,84	11-23-342/784
7,86	11-23-342/786
7,88	11-23-342/788
7,90	11-23-342/790
7,92	11-23-342/792
7,94	11-23-342/794
7,96	11-23-342/796
7,98	11-23-342/798
8,00	11-23-342/800
8,02	11-23-342/802
8,04	11-23-342/804
8,06	11-23-342/806
8,08	11-23-342/808
8,10	11-23-342/810
8,12	11-23-342/812
8,14	11-23-342/814
8,16	11-23-342/816
8,18	11-23-342/818

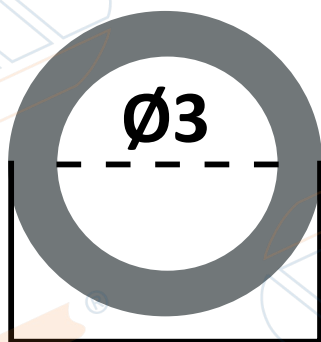
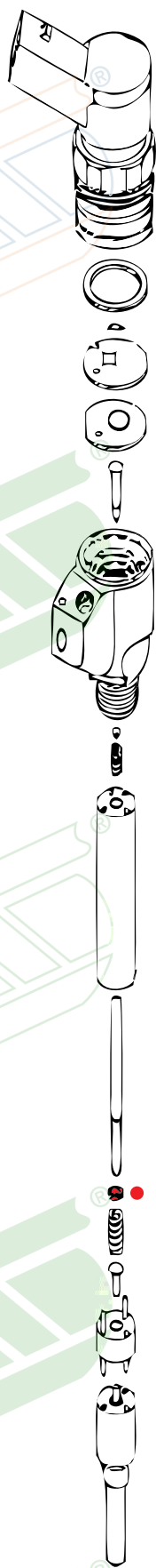

Ø5,7

da 1,00.. a 2,30

ALTRE MISURE DISPONIBILI A RICHIESTA
OTHER SIZES AVAILABLE UPON REQUEST
OTROS TAMAÑOS DISPONIBLES BAJO PETICIÓN
ДРУГИЕ РАЗМЕРЫ ДОСТУПНЫ ПО ЗАПРОСУ
根據要求提供其它尺寸

CODICE OMS	SPESSORE	INCREMENTO	N° PEZZI
11-23-335	DA 1,25 A 1,80	0,05	120



HANDBAG | VALIGETTA 12 POSIZIONI | POSITION

CODICE OMS	SPESSORE	INCREMENTO	N° PEZZI
11-23-336	DA 1,26 A 1,72	0,02	240

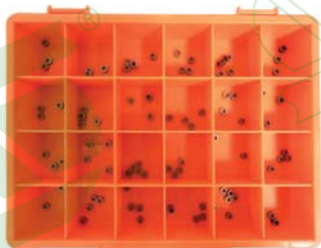

HANDBAG | VALIGETTA 24 POSIZIONI | POSITION

CODICE OMS	SPESSORE	INCREMENTO	N° PEZZI
11-23-414	DA 1,20 A 1,90	0,02	360
11-23-958	DA 1,90 A 2,60	0,02	360



HANDBAG | VALIGETTA 36 POSIZIONI | POSITION

CODICE SINGOLI SPESSORI CODE INDIVIDUAL THICKNESSES

MISURA	COD. OMS	MISURA	COD. OMS
1,00	11-23-335/100	1,66	11-23-335/166
1,02	11-23-335/102	1,68	11-23-335/168
1,04	11-23-335/104	1,70	11-23-335/170
1,05	11-23-335/105	1,72	11-23-335/172
1,06	11-23-335/106	1,74	11-23-335/174
1,08	11-23-335/108	1,75	11-23-335/175
1,10	11-23-335/110	1,76	11-23-335/176
1,12	11-23-335/112	1,78	11-23-335/178
1,14	11-23-335/114	1,80	11-23-335/180
1,15	11-23-335/115	1,82	11-23-335/182
1,16	11-23-335/116	1,84	11-23-335/184
1,18	11-23-335/118	1,85	11-23-335/185
1,20	11-23-335/120	1,86	11-23-335/186
1,22	11-23-335/122	1,88	11-23-335/188
1,24	11-23-335/124	1,90	11-23-335/190
1,25	11-23-335/125	1,92	11-23-335/192
1,26	11-23-335/126	1,94	11-23-335/194
1,28	11-23-335/128	1,95	11-23-335/195
1,30	11-23-335/130	1,96	11-23-335/196
1,32	11-23-335/132	1,98	11-23-335/198
1,34	11-23-335/134	2,00	11-23-335/200
1,35	11-23-335/135	2,02	11-23-335/202
1,36	11-23-335/136	2,04	11-23-335/204
1,38	11-23-335/138	2,05	11-23-335/205
1,40	11-23-335/140	2,06	11-23-335/206
1,42	11-23-335/142	2,08	11-23-335/208
1,44	11-23-335/144	2,10	11-23-335/210
1,45	11-23-335/145	2,12	11-23-335/212
1,46	11-23-335/146	2,14	11-23-335/214
1,48	11-23-335/148	2,15	11-23-335/215
1,50	11-23-335/150	2,16	11-23-335/216
1,52	11-23-335/152	2,18	11-23-335/218
1,54	11-23-335/154	2,20	11-23-335/220
1,55	11-23-335/155	2,22	11-23-335/222
1,56	11-23-335/156	2,24	11-23-335/224
1,58	11-23-335/158	2,25	11-23-335/225
1,60	11-23-335/160	2,26	11-23-335/226
1,62	11-23-335/162	2,28	11-23-335/228
1,64	11-23-335/164	2,30	11-23-335/230
1,65	11-23-335/165		



SIEMENS

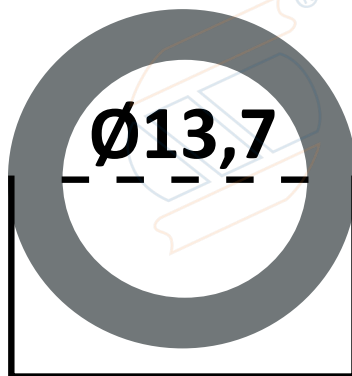
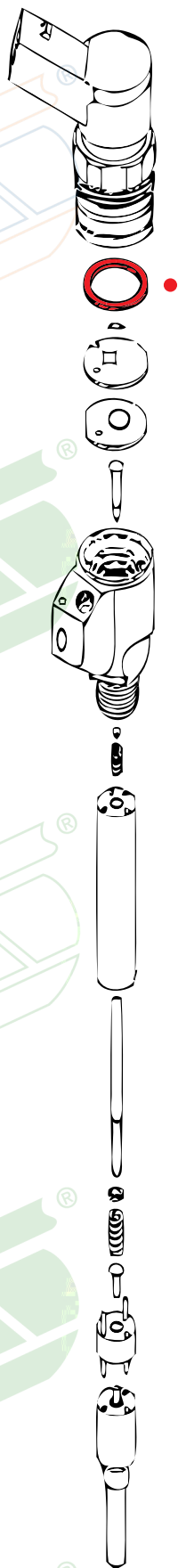

Ø20

da 0,80.. a 1,20

ALTRE MISURE DISPONIBILI A RICHIESTA

OTHER SIZES AVAILABLE UPON REQUEST

OTROS TAMAÑOS DISPONIBLES BAJO PETICIÓN

ДРУГИЕ РАЗМЕРЫ ДОСТУПНЫ ПО ЗАПРОСУ

根據要求提供其它尺寸

CODICE OMS	SPESSORE	INCREMENTO	N° PEZZI
11-23-262	DA 0,80 A 1,20	0,02	210

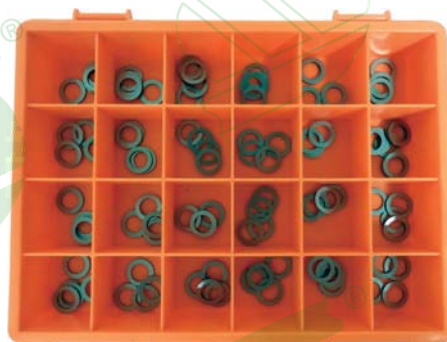

HANDBAG | VALIGETTA 24 POSIZIONI | POSITION

CODICE SINGOLI SPESSORI
CODE INDIVIDUAL THICKNESSES

MISURA	COD. OMS
0,80	11-23-262/080
0,82	11-23-262/082
0,84	11-23-262/084
0,86	11-23-262/086
0,88	11-23-262/088
0,90	11-23-262/090
0,92	11-23-262/092
0,94	11-23-262/094
0,96	11-23-262/096
0,98	11-23-262/098
1,00	11-23-262/100
1,02	11-23-262/102
1,04	11-23-262/104
1,06	11-23-262/106
1,08	11-23-262/108
1,10	11-23-262/110
1,12	11-23-262/112
1,14	11-23-262/114
1,16	11-23-262/116
1,18	11-23-262/118
1,20	11-23-262/120

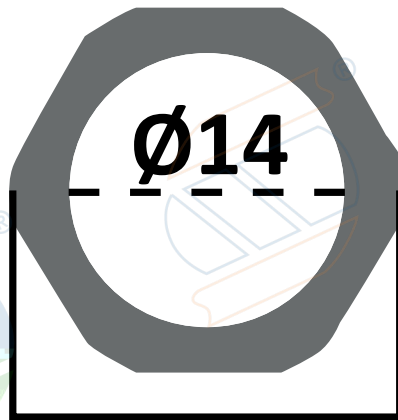
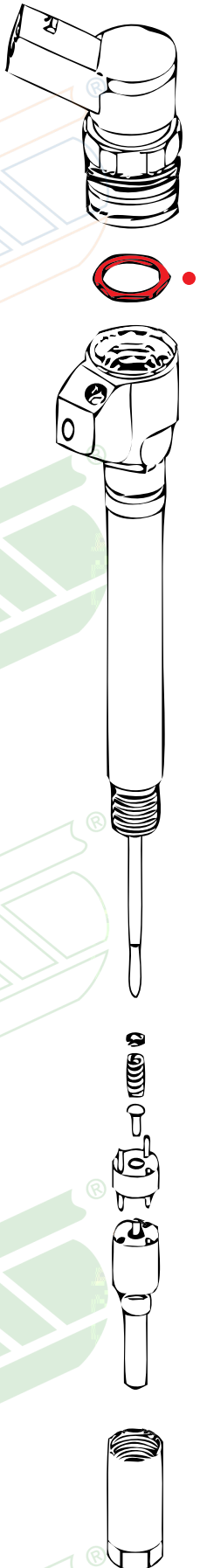

Ø18

da 0,90.. a 1,13
 ALTRE MISURE DISPONIBILI A RICHIESTA
 OTHER SIZES AVAILABLE UPON REQUEST
 OTROS TAMAÑOS DISPONIBLES BAJO PETICIÓN
 ДРУГИЕ РАЗМЕРЫ ДОСТУПНЫ ПО ЗАПРОСУ
 根據要求提供其它尺寸

CODICE OMS	SPESORE	INCREMENTO	N° PEZZI
11-23-337	DA 0,90 A 1,13	0,01	240



HANDBAG | VALIGETTA 24 POSIZIONI | POSITION

CODICE SINGOLI SPESSORI CODE INDIVIDUAL THICKNESSES	
MISURA	COD. OMS
0,90	11-23-337/090
0,91	11-23-337/091
0,92	11-23-337/092
0,93	11-23-337/093
0,94	11-23-337/094
0,95	11-23-337/095
0,96	11-23-337/096
0,97	11-23-337/097
0,98	11-23-337/098
0,99	11-23-337/099
1,00	11-23-337/100
1,01	11-23-337/101
1,02	11-23-337/102
1,03	11-23-337/103
1,04	11-23-337/104
1,05	11-23-337/105
1,06	11-23-337/106
1,07	11-23-337/107
1,08	11-23-337/108
1,09	11-23-337/109
1,10	11-23-337/110
1,11	11-23-337/111
1,12	11-23-337/112
1,13	11-23-337/113



SIEMENS

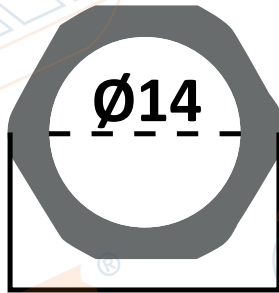
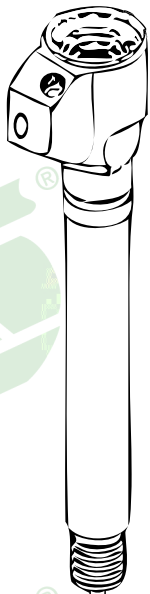
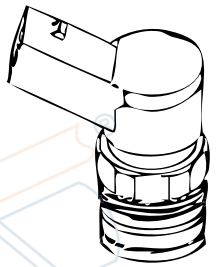

Ø14

Ø18

da 0,900.. a 1,132

ALTRE MISURE DISPONIBILI A RICHIESTA

OTHER SIZES AVAILABLE UPON REQUEST

OTROS TAMAÑOS DISPONIBLES BAJO PETICIÓN

ДРУГИЕ РАЗМЕРЫ ДОСТУПНЫ ПО ЗАПРОСУ

根據要求提供其它尺寸

CODICE OMS	SPESSORE	INCREMENTO	N° PEZZI
11-23-969	da 0,900 a 1,132	0,004	590

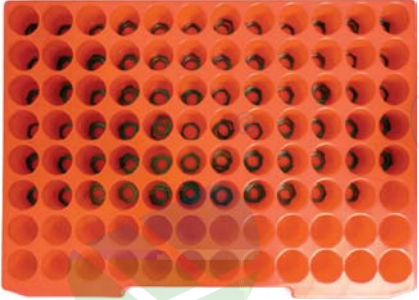

HANDBAG | VALIGETTA 96 POSIZIONI | POSITION

CODICE SINGOLI SPESSORI CODE INDIVIDUAL THICKNESSES			
MISURA	COD. OMS	MISURA	COD. OMS
0,900	11-23-969/0900	1,020	11-23-969/1020
0,904	11-23-969/0904	1,024	11-23-969/1024
0,908	11-23-969/0908	1,028	11-23-969/1028
0,912	11-23-969/0912	1,032	11-23-969/1032
0,916	11-23-969/0916	1,036	11-23-969/1036
0,920	11-23-969/0920	1,040	11-23-969/1040
0,924	11-23-969/0924	1,044	11-23-969/1044
0,928	11-23-969/0928	1,048	11-23-969/1048
0,932	11-23-969/0932	1,052	11-23-969/1052
0,936	11-23-969/0936	1,056	11-23-969/1056
0,940	11-23-969/0940	1,060	11-23-969/1060
0,944	11-23-969/0944	1,064	11-23-969/1064
0,948	11-23-969/0948	1,068	11-23-969/1068
0,952	11-23-969/0952	1,072	11-23-969/1072
0,956	11-23-969/0956	1,076	11-23-969/1076
0,960	11-23-969/0960	1,080	11-23-969/1080
0,964	11-23-969/0964	1,084	11-23-969/1084
0,968	11-23-969/0968	1,088	11-23-969/1088
0,972	11-23-969/0972	1,092	11-23-969/1092
0,976	11-23-969/0976	1,096	11-23-969/1096
0,980	11-23-969/0980	1,100	11-23-969/1100
0,984	11-23-969/0984	1,104	11-23-969/1104
0,988	11-23-969/0988	1,108	11-23-969/1108
0,992	11-23-969/0992	1,112	11-23-969/1112
0,996	11-23-969/0996	1,116	11-23-969/1116
1,000	11-23-969/1000	1,120	11-23-969/1120
1,004	11-23-969/1004	1,124	11-23-969/1124
1,008	11-23-969/1008	1,128	11-23-969/1128
1,012	11-23-969/1012	1,132	11-23-969/1132
1,016	11-23-969/1016		



COMMON RAIL

SIEMENS PIEZO

Spessore Esagonale "da Filo"
Exagonal Shim "for Wire"

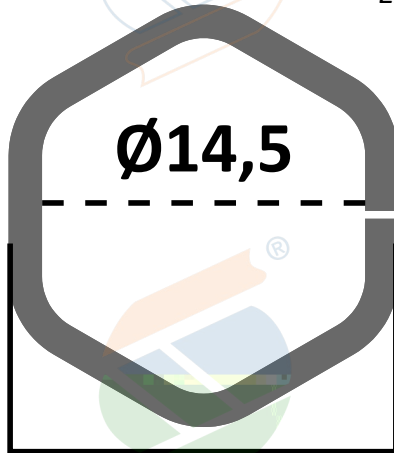

Ø17,5

da 0,90.. a 1,10
ALTRE MISURE DISPONIBILI A RICHIESTA
OTHER SIZES AVAILABLE UPON REQUEST
OTROS TAMAÑOS DISPONIBLES BAJO PETICIÓN
ДРУГИЕ РАЗМЕРЫ ДОСТУПНЫ ПО ЗАПРОСУ
根據要求提供其它尺寸

CODICE OMS	SPESSORE	INCREMENTO	N° PEZZI
02-32-001	DA 0,90 A 1,10	0,02	110



HANDBAG | VALIGETTA **12** POSIZIONI | POSITION

CODICE OMS	SPESSORE	INCREMENTO	N° PEZZI
02-32-001/1	DA 0,90 A 1,10	0,01	210



HANDBAG | VALIGETTA **24** POSIZIONI | POSITION

CODICE SINGOLI SPESSORI CODE INDIVIDUAL THICKNESSES	
MISURA	COD. OMS
0,90	02-32-001/090
0,91	02-32-001/091
0,92	02-32-001/092
0,93	02-32-001/093
0,94	02-32-001/094
0,95	02-32-001/095
0,96	02-32-001/096
0,97	02-32-001/097
0,98	02-32-001/098
0,99	02-32-001/099
1,00	02-32-001/100
1,01	02-32-001/101
1,02	02-32-001/102
1,03	02-32-001/103
1,04	02-32-001/104
1,05	02-32-001/105
1,06	02-32-001/106
1,07	02-32-001/107
1,08	02-32-001/108
1,09	02-32-001/109
1,10	02-32-001/110

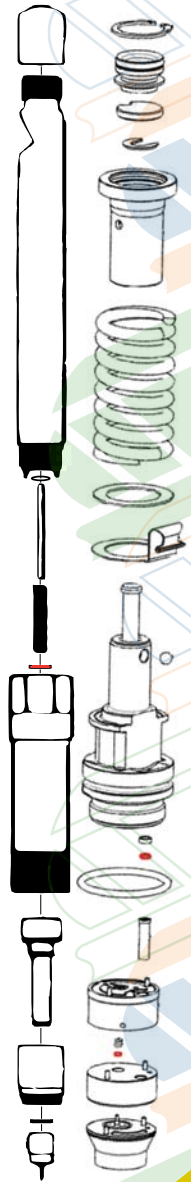
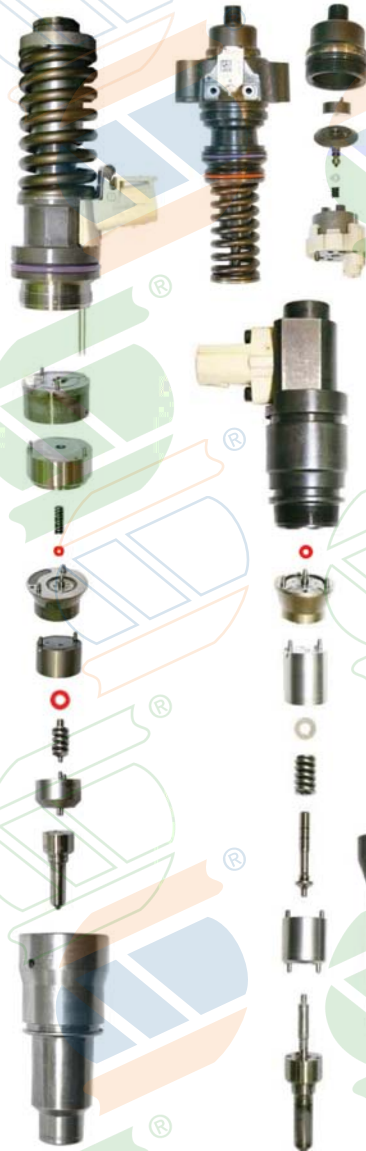
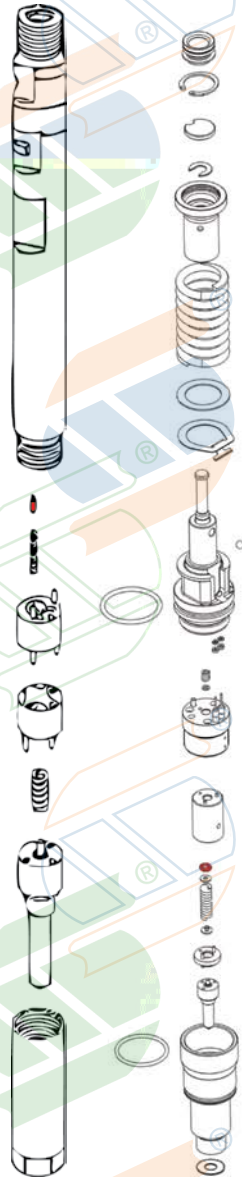
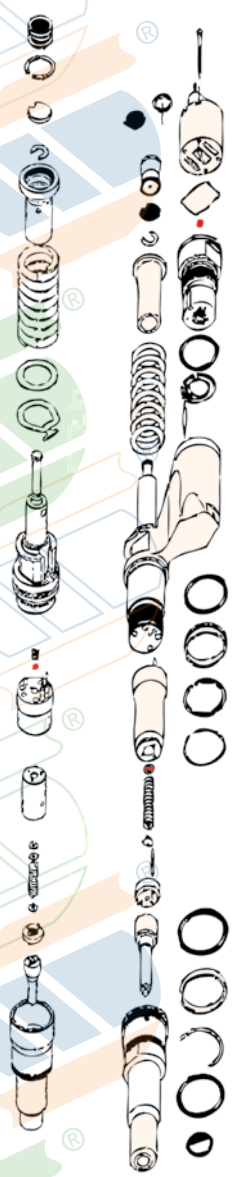

DELPHI



EUI

DELPHI Inietture Pompa

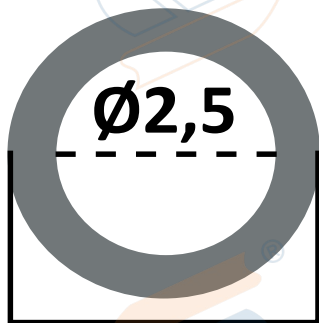

Ø2,5

Ø5

da 0,50.. a 1,22
 ALTRE MISURE DISPONIBILI A RICHIESTA
 OTHER SIZES AVAILABLE UPON REQUEST
 OTROS TAMAÑOS DISPONIBLES BAJO PETICIÓN
 ДРУГИЕ РАЗМЕРЫ ДОСТУПНЫ ПО ЗАПРОСУ
 根據要求提供其它尺寸

CODICE OMS	SPESORE	INCREMENTO	N° PEZZI
11-23-749	DA 0,50 A 1,05	0,05	120



HANDBAG | VALIGETTA 12 POSIZIONI | POSITION

CODICE OMS	SPESORE	INCREMENTO	N° PEZZI
11-23-415	DA 0,502 A 0,995	0,017	300



HANDBAG | VALIGETTA 36 POSIZIONI | POSITION

CODICE OMS	SPESORE	INCREMENTO	N° PEZZI
11-23-750	DA 0,50 A 1,22	0,02	370



HANDBAG | VALIGETTA 54 POSIZIONI | POSITION

TABELLA CODICI ORIGINALI ORIGINAL CODES TABLE

MISURA	RIF. ORIGINALE	COD.OMS
0,502	7206-0188A	11-23-415/0502
0,519	7206-0188B	11-23-415/0519
0,536	7206-0188C	11-23-415/0536
0,553	7206-0188D	11-23-415/0553
0,570	7206-0188E	11-23-415/0570
0,587	7206-0188F	11-23-415/0587
0,604	7206-0188G	11-23-415/0604
0,621	7206-0188H	11-23-415/0621
0,638	7206-0188J	11-23-415/0638
0,655	7206-0188K	11-23-415/0655
0,672	7206-0188L	11-23-415/0672
0,689	7206-0188M	11-23-415/0689
0,706	7206-0188N	11-23-415/0706
0,723	7206-0188P	11-23-415/0723
0,740	7206-0188Q	11-23-415/0740
0,757	7206-0188R	11-23-415/0757
0,774	7206-0188S	11-23-415/0774
0,791	7206-0188T	11-23-415/0791
0,808	7206-0188U	11-23-415/0808
0,825	7206-0188V	11-23-415/0825
0,842	7206-0188W	11-23-415/0842
0,859	7206-0188X	11-23-415/0859
0,876	7206-0188Y	11-23-415/0876
0,893	7206-0188Z	11-23-415/0893
0,910	7206-0188AA	11-23-415/0910
0,927	7206-0188AB	11-23-415/0927
0,944	7206-0188AC	11-23-415/0944
0,961	7206-0188AD	11-23-415/0961
0,978	7206-0188AE	11-23-415/0978
0,995	7206-0188AF	11-23-415/0995

CODICE SINGOLI SPessori CODE INDIVIDUAL THICKNESSES

MISURA	COD. OMS
0,50	11-23-750/050
0,52	11-23-750/052
0,54	11-23-750/054
0,55	11-23-750/055
0,56	11-23-750/056
0,58	11-23-750/058
0,60	11-23-750/060
0,62	11-23-750/062
0,64	11-23-750/064
0,65	11-23-750/065
0,66	11-23-750/066
0,68	11-23-750/068
0,70	11-23-750/070
0,72	11-23-750/072
0,74	11-23-750/074
0,75	11-23-750/075
0,76	11-23-750/076
0,78	11-23-750/078
0,80	11-23-750/080
0,82	11-23-750/082
0,84	11-23-750/084
0,85	11-23-750/085
0,86	11-23-750/086
0,88	11-23-750/088
0,90	11-23-750/090
0,92	11-23-750/092
0,94	11-23-750/094
0,95	11-23-750/095
0,96	11-23-750/096
0,98	11-23-750/098
1,00	11-23-750/100
1,02	11-23-750/102
1,04	11-23-750/104
1,05	11-23-750/105
1,06	11-23-750/106
1,08	11-23-750/108
1,10	11-23-750/110
1,12	11-23-750/112
1,14	11-23-750/114
1,16	11-23-750/116
1,18	11-23-750/118
1,20	11-23-750/120
1,22	11-23-750/122

DELPHI Inietture Pompa

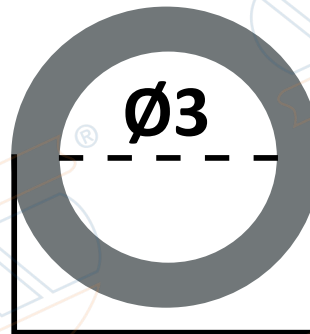

Ø7,5

da 0,44.. a 1,56

ALTRE MISURE DISPONIBILI A RICHIESTA

OTHER SIZES AVAILABLE UPON REQUEST

OTROS TAMAÑOS DISPONIBLES BAJO PETICIÓN

ДРУГИЕ РАЗМЕРЫ ДОСТУПНЫ ПО ЗАПРОСУ

根據要求提供其它尺寸

CODICE OMS	SPESORE	INCREMENTO	N° PEZZI
11-23-394	DA 0,44 A 0,62	0,02	100
11-23-751	DA 0,50 A 1,05	0,05	120



HANDBAG | VALIGETTA **12** POSIZIONI | POSITION

CODICE OMS	SPESORE	INCREMENTO	N° PEZZI
11-23-651	DA 0,44 A 1,56	-	190
11-23-752	DA 0,52 A 1,00	0,02	240

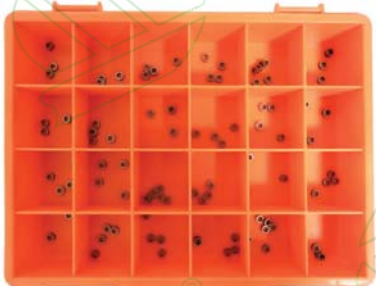

HANDBAG | VALIGETTA **24** POSIZIONI | POSITION

TABELLA CODICI ORIGINALI ORIGINAL CODES TABLE

MISURA	RIF. ORIGINALE	COD.OMS	MISURA	RIF. ORIGINALE	COD.OMS
0,44	7169-706KC	11-23-394/044	0,60	7169-706KL	11-23-394/060
0,46	7169-706KD	11-23-394/046	0,62	7169-706KM	11-23-394/062
0,48	7169-706KE	11-23-394/048	0,64	7169-706KN	11-23-394/064
0,50	7169-706KF	11-23-394/050	0,66	7169-706KP	11-23-394/066
0,52	7169-706KG	11-23-394/052	0,68	7169-706KR	11-23-394/068
0,54	7169-706KH	11-23-394/054	0,70	7169-706KS	11-23-394/070
0,56	7169-706KJ	11-23-394/056	0,96	-	11-23-394/096
0,58	7169-706KK	11-23-394/058	0,98	-	11-23-394/098
			1,00	7169-706KT	11-23-394/100
			1,28	7169-706KU	11-23-394/128
			1,56	7169-706KV	11-23-394/156



EUI

DELPHI Iniettore Pompa

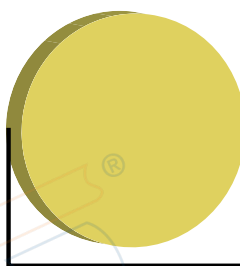

Ø5,8

OTTONE SENZA FORO
brass without hole
latón sin agujero

da 2,24.. a 2,94

ALTRE MISURE DISPONIBILI A RICHIESTA
OTHER SIZES AVAILABLE UPON REQUEST
OTROS TAMAÑOS DISPONIBLES BAJO PETICIÓN
ДРУГИЕ РАЗМЕРЫ ДОСТУПНЫ ПО ЗАПРОСУ
根據要求提供其它尺寸

CODICE OMS	SPESORE	INCREMENTO	N° PEZZI
11-23-366	DA 2,24 A 2,94	0,02	360

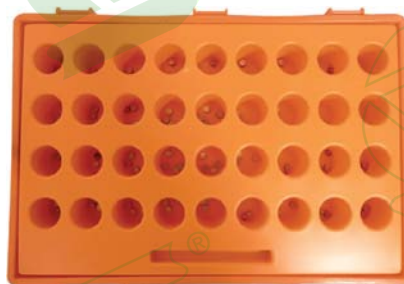

HANDBAG | VALIGETTA 36 POSIZIONI | POSITION

TABELLA CODICI ORIGINALI ORIGINAL CODES TABLE

MISURA	RIF. ORIGINALE	COD.OMS	MISURA	RIF. ORIGINALE	COD.OMS
2,24	7204-142A	11-23-366/224	2,60	7204-142U	11-23-366/260
2,26	7204-142B	11-23-366/226	2,62	7204-142V	11-23-366/262
2,28	7204-142C	11-23-366/228	2,64	7204-142W	11-23-366/264
2,30	7204-142D	11-23-366/230	2,66	7204-142X	11-23-366/266
2,32	7204-142E	11-23-366/232	2,68	7204-142Y	11-23-366/268
2,34	7204-142F	11-23-366/234	2,70	7204-142Z	11-23-366/270
2,36	7204-142G	11-23-366/236	2,72	7204-142AA	11-23-366/272
2,38	7204-142H	11-23-366/238	2,74	7204-142AB	11-23-366/274
2,40	7204-142J	11-23-366/240	2,76	7204-142AC	11-23-366/276
2,42	7204-142K	11-23-366/242	2,78	7204-142AD	11-23-366/278
2,44	7204-142L	11-23-366/244	2,80	7204-142AE	11-23-366/280
2,46	7204-142M	11-23-366/246	2,82	7204-142AF	11-23-366/282
2,48	7204-142N	11-23-366/248	2,84	7204-142AG	11-23-366/284
2,50	7204-142P	11-23-366/250	2,86	7204-142AH	11-23-366/286
2,52	7204-142Q	11-23-366/252	2,88	7204-142AJ	11-23-366/288
2,54	7204-142R	11-23-366/254	2,90	7204-142AK	11-23-366/290
2,56	7204-142S	11-23-366/256	2,92	7204-142AL	11-23-366/292
2,58	7204-142T	11-23-366/258	2,94	7204-142AM	11-23-366/294



DELPHI

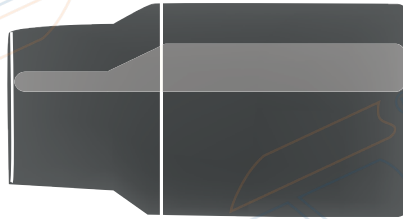
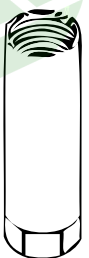
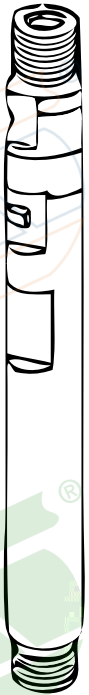

da 2,85.. a 4,95

ALTRE MISURE DISPONIBILI A RICHIESTA

OTHER SIZES AVAILABLE UPON REQUEST

OTROS TAMAÑOS DISPONIBLES BAJO PETICIÓN

ДРУГИЕ РАЗМЕРЫ ДОСТУПНЫ ПО ЗАПРОСУ

根據要求提供其它尺寸

CODICE OMS	SPESORE	INCREMENTO	N° PEZZI
11-23-339	DA 3,80 A 4,90	0,10	120
11-23-339/1	DA 2,85 A 3,95	0,10	120



HANDBAG | VALIGETTA 12 POSIZIONI | POSITION

CODICE OMS	SPESORE	INCREMENTO	N° PEZZI
11-23-338	DA 3,75 A 4,90	0,05	240

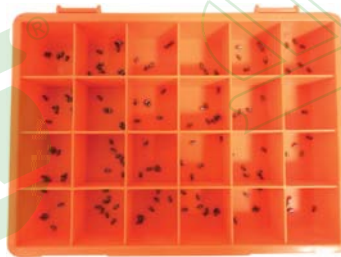

HANDBAG | VALIGETTA 24 POSIZIONI | POSITION

CODICE OMS	SPESORE	INCREMENTO	N° PEZZI
11-23-339/2	DA 2,85 A 4,60	0,05	360

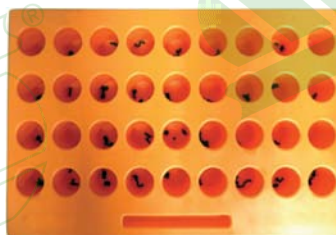

HANDBAG | VALIGETTA 36 POSIZIONI | POSITION

CODICE SINGOLI SPESSORI
CODE INDIVIDUAL THICKNESSES

MISURA	COD. OMS
2,85	11-23-338/285
2,90	11-23-338/290
2,95	11-23-338/295
3,00	11-23-338/300
3,05	11-23-338/305
3,10	11-23-338/310
3,15	11-23-338/315
3,20	11-23-338/320
3,25	11-23-338/325
3,30	11-23-338/330
3,35	11-23-338/335
3,40	11-23-338/340
3,45	11-23-338/345
3,50	11-23-338/350
3,55	11-23-338/355
3,60	11-23-338/360
3,65	11-23-338/365
3,70	11-23-338/370
3,75	11-23-338/375
3,80	11-23-338/380
3,85	11-23-338/385
3,90	11-23-338/390
3,95	11-23-338/395
4,00	11-23-338/400
4,05	11-23-338/405
4,10	11-23-338/410
4,15	11-23-338/415
4,20	11-23-338/420
4,25	11-23-338/425
4,30	11-23-338/430
4,35	11-23-338/435
4,40	11-23-338/440
4,45	11-23-338/445
4,50	11-23-338/450
4,55	11-23-338/455
4,60	11-23-338/460
4,65	11-23-338/465
4,70	11-23-338/470
4,75	11-23-338/475
4,80	11-23-338/480
4,85	11-23-338/485
4,90	11-23-338/490
4,95	11-23-338/495

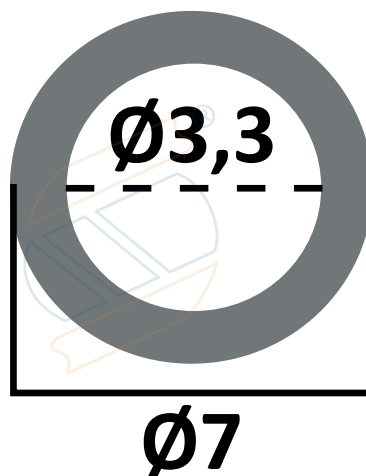

da 0,30.. a 1,60
 ALTRE MISURE DISPONIBILI A RICHIESTA
 OTHER SIZES AVAILABLE UPON REQUEST
 OTROS TAMAÑOS DISPONIBLES BAJO PETICIÓN
 ДРУГИЕ РАЗМЕРЫ ДОСТУПНЫ ПО ЗАПРОСУ
 根據要求提供其它尺寸



TABELLA CODICI ORIGINALI ORIGINAL CODES TABLE

MISURA	RIF. ORIGINALE	COD.OMS
0,30	7207-0178A	11-23-727/030
0,42	7207-0178B	11-23-727/042
0,44	7207-0178C	11-23-727/044
0,46	7207-0178D	11-23-727/046
0,48	7207-0178E	11-23-727/048
0,50	7207-0178F	11-23-727/050
0,52	7207-0178G	11-23-727/052
0,54	7207-0178H	11-23-727/054
0,56	7207-0178J	11-23-727/056
0,58	7207-0178K	11-23-727/058
0,60	7207-0178L	11-23-727/060
0,62	7207-0178M	11-23-727/062
0,64	7207-0178N	11-23-727/064
0,66	7207-0178P	11-23-727/066
0,68	7207-0178R	11-23-727/068
0,70	7207-0178S	11-23-727/070
1,00	7207-0178T	11-23-727/100
1,28	7207-0178U	11-23-727/128
1,56	7207-0178V	11-23-727/156
1,60	-	11-23-727/160

CODICE OMS	SPESORE	INCREMENTO	N° PEZZI
11-23-727	DA 0,30 A 1,60	0,02	200

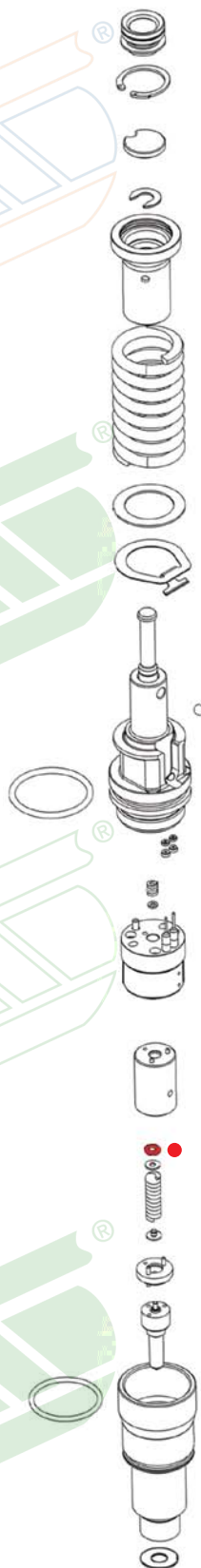

HANDBAG | VALIGETTA 24 POSIZIONI | POSITION



DELPHI

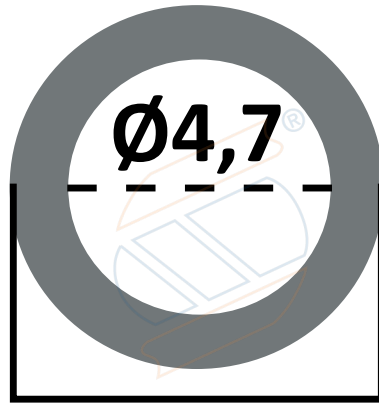

Ø9,35

da 0,40.. a 0,80

ALTRE MISURE DISPONIBILI A RICHIESTA

OTHER SIZES AVAILABLE UPON REQUEST

OTROS TAMAÑOS DISPONIBLES BAJO PETICIÓN

ДРУГИЕ РАЗМЕРЫ ДОСТУПНЫ ПО ЗАПРОСУ

根據要求提供其它尺寸

CODICE OMS	SPESSORE	INCREMENTO	N° PEZZI
11-23-745	DA 0,40 A 0,80	0,02	210

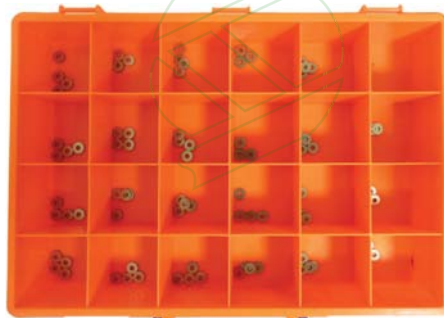

HUSBAG | VALIGETTA 24 POSIZIONI | POSITION

CODICE SINGOLI SPESSORI
CODE INDIVIDUAL
THICKNESSES

MISURA	COD. OMS
0,40	11-23-745/040
0,42	11-23-745/042
0,44	11-23-745/044
0,46	11-23-745/046
0,48	11-23-745/048
0,50	11-23-745/050
0,52	11-23-745/052
0,54	11-23-745/054
0,56	11-23-745/056
0,58	11-23-745/058
0,60	11-23-745/060
0,62	11-23-745/062
0,64	11-23-745/064
0,66	11-23-745/066
0,68	11-23-745/068
0,70	11-23-745/070
0,72	11-23-745/072
0,74	11-23-745/074
0,76	11-23-745/076
0,78	11-23-745/078
0,80	11-23-745/080



COMMON RAIL

DELPHI

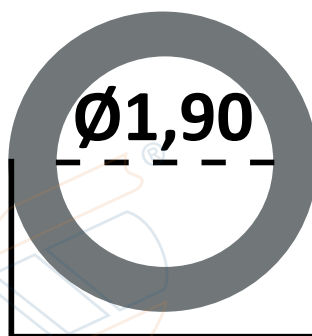

Ø4,35

da 1,15.. a 1,70

ALTRE MISURE DISPONIBILI A RICHIESTA
OTHER SIZES AVAILABLE UPON REQUEST
OTROS TAMAÑOS DISPONIBLES BAJO PETICIÓN
ДРУГИЕ РАЗМЕРЫ ДОСТУПНЫ ПО ЗАПРОСУ
根據要求提供其它尺寸

CODICE OMS	SPESSORE	INCREMENTO	N° PEZZI
11-23-758	DA 1,15 A 1,70	0,05	120



HANDBAG | VALIGETTA 12 POSIZIONI | POSITION

CODICE OMS	SPESSORE	INCREMENTO	N° PEZZI
11-23-759	DA 1,20 A 1,70	0,02	240

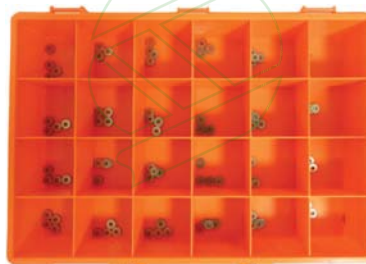

HANDBAG | VALIGETTA 24 POSIZIONI | POSITION

CODICE SINGOLI SPESSORI CODE INDIVIDUAL THICKNESSES

MISURA	COD. OMS	MISURA	COD. OMS
1,15	11-23-758/115	1,44	11-23-758/144
1,16	11-23-758/116	1,45	11-23-758/145
1,18	11-23-758/118	1,46	11-23-758/146
1,20	11-23-758/120	1,48	11-23-758/148
1,22	11-23-758/122	1,50	11-23-758/150
1,24	11-23-758/124	1,52	11-23-758/152
1,25	11-23-758/125	1,54	11-23-758/154
1,26	11-23-758/126	1,55	11-23-758/155
1,28	11-23-758/128	1,56	11-23-758/156
1,30	11-23-758/130	1,58	11-23-758/158
1,32	11-23-758/132	1,60	11-23-758/160
1,34	11-23-758/134	1,62	11-23-758/162
1,35	11-23-758/135	1,64	11-23-758/164
1,36	11-23-758/136	1,65	11-23-758/165
1,38	11-23-758/138	1,66	11-23-758/166
1,40	11-23-758/140	1,68	11-23-758/168
1,42	11-23-758/142	1,70	11-23-758/170



DELPHI

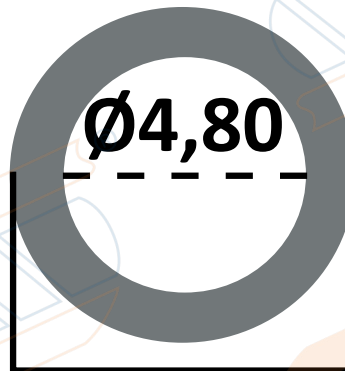

Ø8,35

da 0,40.. a 0,80

ALTRE MISURE DISPONIBILI A RICHIESTA
OTHER SIZES AVAILABLE UPON REQUEST
OTROS TAMAÑOS DISPONIBLES BAJO PETICIÓN
ДРУГИЕ РАЗМЕРЫ ДОСТУПНЫ ПО ЗАПРОСУ
根據要求提供其它尺寸

CODICE OMS	SPESORE	INCREMENTO	N° PEZZI
11-23-747	DA 0,40 A 0,80	0,02	210

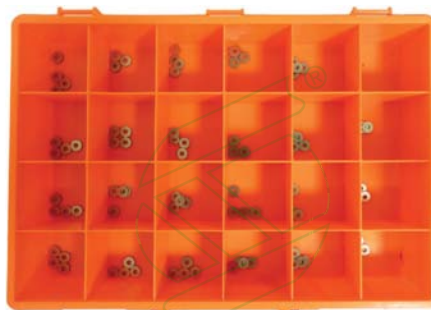

HANDBAG | VALIGETTA 24 POSIZIONI | POSITION

CODICE SINGOLI SPessori
CODE INDIVIDUAL THICKNESSES

MISURA	COD. OMS
0,40	11-23-747/040
0,42	11-23-747/042
0,44	11-23-747/044
0,46	11-23-747/046
0,48	11-23-747/048
0,50	11-23-747/050
0,52	11-23-747/052
0,54	11-23-747/054
0,56	11-23-747/056
0,58	11-23-747/058
0,60	11-23-747/060
0,62	11-23-747/062
0,64	11-23-747/064
0,66	11-23-747/066
0,68	11-23-747/068
0,70	11-23-747/070
0,72	11-23-747/072
0,74	11-23-747/074
0,76	11-23-747/076
0,78	11-23-747/078
0,80	11-23-747/080



SPINA DI PRESSIONE
pressure pin
presión pin

da 42,860.. a 43,205
ALTRE MISURE DISPONIBILI A RICHIESTA
OTHER SIZES AVAILABLE UPON REQUEST
OTROS TAMAÑOS DISPONIBLES BAJO PETICIÓN
ДРУГИЕ РАЗМЕРЫ ДОСТУПНЫ ПО ЗАПРОСУ
根據要求提供其它尺寸

TABELLA CODICI ORIGINALI ORIGINAL CODES TABLE

MISURA	RIF. ORIGINALE	COD.OMS
42,905	7169-740AA	02-20-030/1
42,920	7169-740AB	02-20-030/2
42,935	7169-740AC	02-20-030/3
42,950	7169-740AD	02-20-030/4
42,965	7169-740AE	02-20-030/5
42,980	7169-740AF	02-20-030/6
42,995	7169-740AG	02-20-030/7
43,010	7169-740AH	02-20-030/8
43,025	7169-740AJ	02-20-030/9
43,040	7169-740AK	02-20-030/10
43,055	7169-740AL	02-20-030/11
43,070	7169-740AM	02-20-030/12
43,085	7169-740AN	02-20-030/13
43,100	7169-740AP	02-20-030/14
43,115	7169-740AQ	02-20-030/15
43,130	7169-740AR	02-20-030/16
43,145	7169-740AS	02-20-030/17
43,160	7169-740AT	02-20-030/18
43,175	7169-740AU	02-20-030/19
43,190	7169-740AV	02-20-030/20
43,205	7169-740AW	02-20-030/21
42,860	7169-740AY	02-20-030/22
42,890	7169-740AZ	02-20-030/23

CODICE OMS	SPESORE	INCREMENTO	N° PEZZI
02-20-030	DA 42,905 A 43,205	0,015	210



HANDBAG | VALIGETTA 24 POSIZIONI | POSITION

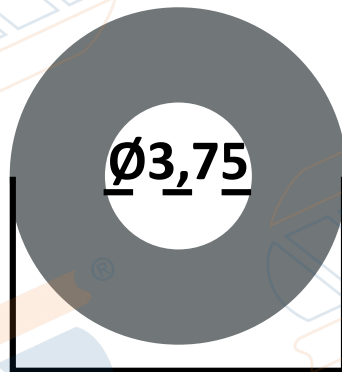

DELPHI

 $\varnothing 3,75$
 $\varnothing 7,50$
da 0,30.. a 1,60

ALTRE MISURE DISPONIBILI A RICHIESTA
 OTHER SIZES AVAILABLE UPON REQUEST
 OTROS TAMAÑOS DISPONIBLES BAJO PETICIÓN
 ДРУГИЕ РАЗМЕРЫ ДОСТУПНЫ ПО ЗАПРОСУ
 根據要求提供其它尺寸



HANDBAG | VALIGETTA 96 POSIZIONI | POSITION

TABELLA CODICI ORIGINALI
ORIGINAL CODES TABLE

MISURA	RIF. ORIGINALE	COD.OMS	MISURA	RIF. ORIGINALE	COD.OMS
0.30	7169-744A	02-20-032/030	1.00	7169-744T	02-20-032/100
0.40	7169-744W	02-20-032/040	1.02	7169-744AM	02-20-032/102
0.42	7169-744B	02-20-032/042	1.04	7169-744AN	02-20-032/104
0.44	7169-744C	02-20-032/044	1.06	7169-744AP	02-20-032/106
0.46	7169-744D	02-20-032/046	1.08	7169-744AQ	02-20-032/108
0.48	7169-744E	02-20-032/048	1.10	7169-744AR	02-20-032/110
0.50	7169-744F	02-20-032/050	1.12	7169-744AS	02-20-032/112
0.52	7169-744G	02-20-032/052	1.14	7169-744AT	02-20-032/114
0.54	7169-744H	02-20-032/054	1.16	7169-744AU	02-20-032/116
0.56	7169-744J	02-20-032/056	1.18	7169-744AV	02-20-032/118
0.58	7169-744K	02-20-032/058	1.20	7169-744AW	02-20-032/120
0.60	7169-744L	02-20-032/060	1.22	7169-744AX	02-20-032/122
0.62	7169-744M	02-20-032/062	1.24	7169-744AY	02-20-032/124
0.64	7169-744N	02-20-032/064	1.26	7169-744AZ	02-20-032/126
0.66	7169-744P	02-20-032/066	1.28	7169-744U	02-20-032/128
0.68	7169-744R	02-20-032/068	1.30	7169-744BA	02-20-032/130
0.70	7169-744S	02-20-032/070	1.32	7169-744BB	02-20-032/132
0.72	7169-744X	02-20-032/072	1.34	7169-744BC	02-20-032/134
0.74	7169-744Y	02-20-032/074	1.36	7169-744BD	02-20-032/136
0.76	7169-744Z	02-20-032/076	1.38	7169-744BE	02-20-032/138
0.78	7169-744AA	02-20-032/078	1.40	7169-744BF	02-20-032/140
0.80	7169-744AB	02-20-032/080	1.42	7169-744BG	02-20-032/142
0.82	7169-744AC	02-20-032/082	1.44	7169-744BH	02-20-032/144
0.84	7169-744AD	02-20-032/084	1.46	7169-744BJ	02-20-032/146
0.86	7169-744AE	02-20-032/086	1.48	7169-744BQ	02-20-032/148
0.88	7169-744AF	02-20-032/088	1.50	7169-744BK	02-20-032/150
0.90	7169-744AG	02-20-032/090	1.52	7169-744BL	02-20-032/152
0.92	7169-744AH	02-20-032/092	1.54	7169-744BM	02-20-032/154
0.94	7169-744AJ	02-20-032/094	1.56	7169-744V	02-20-032/156
0.96	7169-744AK	02-20-032/096	1.58	7169-744BN	02-20-032/158
0.98	7169-744AL	02-20-032/098	1.60	7169-744BP	02-20-032/160



COMMON RAIL

DELPHI

da 0,40.. a 1,66

ALTRE MISURE DISPONIBILI A RICHIESTA

OTHER SIZES AVAILABLE UPON REQUEST

OTROS TAMAÑOS DISPONIBLES BAJO PETICIÓN

ДРУГИЕ РАЗМЕРЫ ДОСТУПНЫ ПО ЗАПРОСУ

根據要求提供其它尺寸

Ø1,90

Ø4,4

CODICE OMS	SPESSORE	N° PEZZI
02-20-033	0,48 - 0,60 - 0,76 - 0,80 - 0,84 - 0,88 0,92 - 0,96 - 1,00 - 1,04 - 1,08 - 1,12 1,16 - 1,20 - 1,24 - 1,28 - 1,40	170

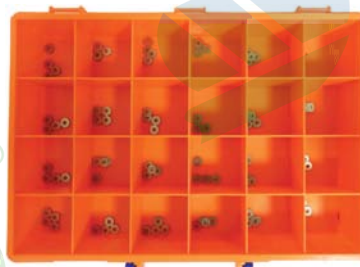

HANDBAG | VALIGETTA 24 POSIZIONI | POSITION

DISPONIBILI

A RICHIESTA

TABELLA CODICI ORIGINALI ORIGINAL CODES TABLE

MISURA	RIF. ORIGINALE	COD.OMS	MISURA	RIF. ORIGINALE	COD.OMS
0.40	7206-0248A	02-20-033/040	1.04	7206-0248S	02-20-033/104
0.42	7206-0248BA	02-20-033/042	1.06	7206-0248BS	02-20-033/106
0.44	7206-0248B	02-20-033/044	1.08	7206-0248T	02-20-033/108
0.46	7206-0248BB	02-20-033/046	1.10	7206-0248BT	02-20-033/110
0.48	7206-0248C	02-20-033/048	1.12	7206-0248U	02-20-033/112
0.50	7206-0248BC	02-20-033/050	1.14	7206-0248BU	02-20-033/114
0.52	7206-0248D	02-20-033/052	1.16	7206-0248V	02-20-033/116
0.54	7206-0248BD	02-20-033/054	1.18	7206-0248BV	02-20-033/118
0.56	7206-0248E	02-20-033/056	1.20	7206-0248W	02-20-033/120
0.58	7206-0248BE	02-20-033/058	1.22	7206-0248BW	02-20-033/122
0.60	7206-0248F	02-20-033/060	1.24	7206-0248X	02-20-033/124
0.62	7206-0248BF	02-20-033/062	1.26	7206-0248BX	02-20-033/126
0.64	7206-0248G	02-20-033/064	1.28	7206-0248Y	02-20-033/128
0.66	7206-0248BG	02-20-033/066	1.30	7206-0248BY	02-20-033/130
0.68	7206-0248H	02-20-033/068	1.32	7206-0248Z	02-20-033/132
0.70	7206-0248BH	02-20-033/070	1.34	7206-0248BZ	02-20-033/134
0.72	7206-0248J	02-20-033/072	1.36	7206-0248AA	02-20-033/136
0.74	7206-0248BJ	02-20-033/074	1.38	7206-0248CA	02-20-033/138
0.76	7206-0248K	02-20-033/076	1.40	7206-0248AB	02-20-033/140
0.78	7206-0248BK	02-20-033/078	1.42	7206-0248CB	02-20-033/142
0.80	7206-0248L	02-20-033/080	1.44	7206-0248AC	02-20-033/144
0.82	7206-0248BL	02-20-033/082	1.46	7206-0248CC	02-20-033/146
0.84	7206-0248M	02-20-033/084	1.48	7206-0248AD	02-20-033/148
0.86	7206-0248BM	02-20-033/086	1.50	7206-0248CD	02-20-033/150
0.88	7206-0248N	02-20-033/088	1.52	7206-0248AE	02-20-033/152
0.90	7206-0248BN	02-20-033/090	1.54	7206-0248CE	02-20-033/154
0.92	7206-0248P	02-20-033/092	1.56	7206-0248AF	02-20-033/156
0.94	7206-0248BP	02-20-033/094	1.58	-	02-20-033/158
0.96	7206-0248Q	02-20-033/096	1.60	-	02-20-033/160
0.98	7206-0248BQ	02-20-033/098	1.62	-	02-20-033/162
1.00	7206-0248R	02-20-033/100	1.64	-	02-20-033/164
1.02	7206-0248BR	02-20-033/102	1.66	-	02-20-033/166



DELPHI

da 0,400.. a 1,048

ALTRE MISURE DISPONIBILI A RICHIESTA

OTHER SIZES AVAILABLE UPON REQUEST

OTROS TAMAÑOS DISPONIBLES BAJO PETICIÓN

ДРУГИЕ РАЗМЕРЫ ДОСТУПНЫ ПО ЗАПРОСУ

Ø4,6

Ø9,3

CODICE OMS	SPESORE	INCREMENTO	N° PEZZI
02-20-034	DA 0.400 A 0.940	0.012	460
02-20-034/1	DA 0.544 A 1.048	0.012	430

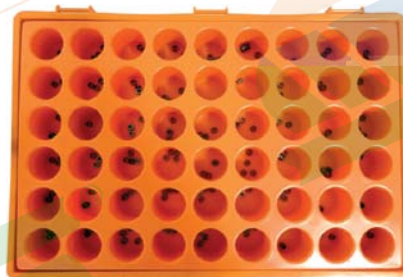

HANDBAG | VALIGETTA 54 POSIZIONI | POSITION

TABELLA CODICI ORIGINALI
ORIGINAL CODES TABLE

MISURA	RIF. ORIGINALE	COD.OMS	MISURA	RIF. ORIGINALE	COD.OMS
0.400	7207-0118A	02-20-034/0400	0.724	7207-0118AD	02-20-034/0724
0.412	7207-0118B	02-20-034/0412	0.736	7207-0118AE	02-20-034/0736
0.424	7207-0118C	02-20-034/0424	0.748	7207-0118AF	02-20-034/0748
0.436	7207-0118D	02-20-034/0436	0.760	7207-0118AG	02-20-034/0760
0.448	7207-0118E	02-20-034/0448	0.772	7207-0118AH	02-20-034/0772
0.460	7207-0118F	02-20-034/0460	0.784	7207-0118AJ	02-20-034/0784
0.472	7207-0118G	02-20-034/0472	0.796	7207-0118AK	02-20-034/0796
0.484	7207-0118H	02-20-034/0484	0.808	7207-0118AL	02-20-034/0808
0.496	7207-0118J	02-20-034/0496	0.820	7207-0118AM	02-20-034/0820
0.508	7207-0118K	02-20-034/0508	0.832	7207-0118AN	02-20-034/0832
0.520	7207-0118L	02-20-034/0520	0.844	7207-0118AP	02-20-034/0844
0.532	7207-0118M	02-20-034/0532	0.856	7207-0118AQ	02-20-034/0856
0.544	7207-0118N	02-20-034/0544	0.868	7207-0118AR	02-20-034/0868
0.556	7207-0118P	02-20-034/0556	0.880	7207-0118AS	02-20-034/0880
0.568	7207-0118Q	02-20-034/0568	0.892	7207-0118AT	02-20-034/0892
0.580	7207-0118R	02-20-034/0580	0.904	7207-0118AU	02-20-034/0904
0.592	7207-0118S	02-20-034/0592	0.916	7207-0118AV	02-20-034/0916
0.604	7207-0118T	02-20-034/0604	0.928	7207-0118AW	02-20-034/0828
0.616	7207-0118U	02-20-034/0616	0.940	7207-0118AX	02-20-034/0940
0.628	7207-0118V	02-20-034/0628	0.952	-	02-20-034/0952
0.640	7207-0118W	02-20-034/0640	0.964	-	02-20-034/0964
0.652	7207-0118X	02-20-034/0652	0.976	-	02-20-034/0976
0.664	7207-0118Y	02-20-034/0664	0.988	-	02-20-034/0988
0.676	7207-0118Z	02-20-034/0676	1.000	-	02-20-034/1000
0.688	7207-0118AA	02-20-034/0688	1.012	-	02-20-034/1012
0.700	7207-0118AB	02-20-034/0700	1.024	-	02-20-034/1024
0.712	7207-0118AC	02-20-034/0712	1.036	-	02-20-034/1036
			1.048	-	02-20-034/1048

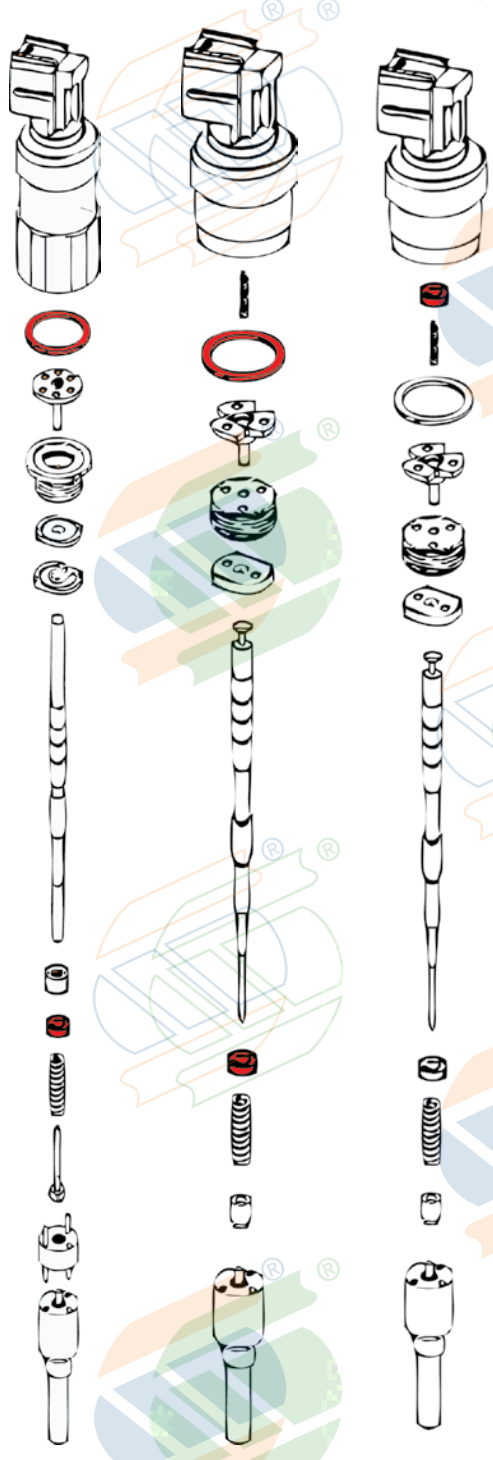

DENSO



DENSO

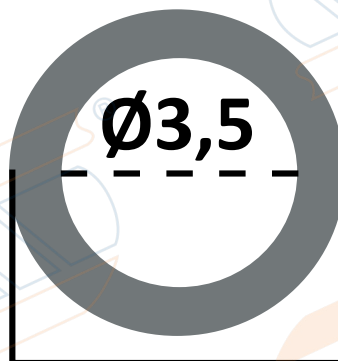

Ø6,75

da 1,00.. a 2,50

ALTRE MISURE DISPONIBILI A RICHIESTA
OTHER SIZES AVAILABLE UPON REQUEST
OTROS TAMAÑOS DISPONIBLES BAJO PETICIÓN
ДРУГИЕ РАЗМЕРЫ ДОСТУПНЫ ПО ЗАПРОСУ
根據要求提供其它尺寸

CODICE OMS	SPESSORE	INCREMENTO	N° PEZZI
11-23-960	da 1,20 a 1,75	0,05	120
11-23-340	da 1,75 a 2,30	0,05	120



HANDBAG|VALIGETTA 12 POSIZIONI|POSITION

CODICE OMS	SPESSORE	INCREMENTO	N° PEZZI
11-23-746	da 1,84 a 2,30	0,02	240



HANDBAG|VALIGETTA 24 POSIZIONI|POSITION

CODICE OMS	SPESSORE	INCREMENTO	N° PEZZI
11-23-959	da 1,20 a 1,74	0,02	280



HANDBAG|VALIGETTA 36 POSIZIONI|POSITION

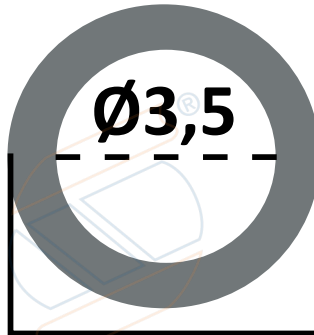

Ø6,75

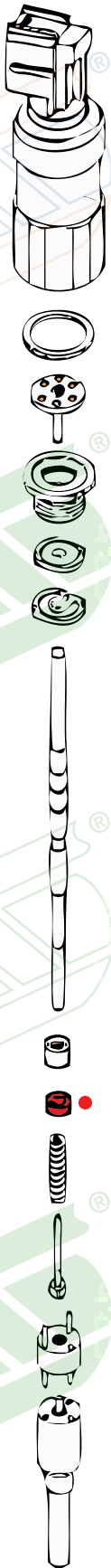

CODICE SINGOLI SPESSORI CODE INDIVIDUAL THICKNESSES

MISURA	COD. OMS	MISURA	COD. OMS	MISURA	COD. OMS
1,00	11-23-340/100	1,52	11-23-340/152	2,02	11-23-340/202
1,02	11-23-340/102	1,54	11-23-340/154	2,04	11-23-340/204
1,04	11-23-340/104	1,55	11-23-340/155	2,05	11-23-340/205
1,05	11-23-340/105	1,56	11-23-340/156	2,06	11-23-340/206
1,06	11-23-340/106	1,58	11-23-340/158	2,08	11-23-340/208
1,08	11-23-340/108	1,60	11-23-340/160	2,10	11-23-340/210
1,10	11-23-340/110	1,62	11-23-340/162	2,12	11-23-340/212
1,12	11-23-340/112	1,64	11-23-340/164	2,14	11-23-340/214
1,14	11-23-340/114	1,65	11-23-340/165	2,15	11-23-340/215
1,15	11-23-340/115	1,66	11-23-340/166	2,16	11-23-340/216
1,16	11-23-340/116	1,68	11-23-340/168	2,18	11-23-340/218
1,18	11-23-340/118	1,70	11-23-340/170	2,20	11-23-340/220
1,20	11-23-340/120	1,72	11-23-340/172	2,22	11-23-340/222
1,22	11-23-340/122	1,74	11-23-340/174	2,24	11-23-340/224
1,24	11-23-340/124	1,75	11-23-340/175	2,25	11-23-340/225
1,25	11-23-340/125	1,76	11-23-340/176	2,26	11-23-340/226
1,26	11-23-340/126	1,78	11-23-340/178	2,28	11-23-340/228
1,28	11-23-340/128	1,80	11-23-340/180	2,30	11-23-340/230
1,30	11-23-340/130	1,82	11-23-340/182	2,32	11-23-340/232
1,32	11-23-340/132	1,84	11-23-340/184	2,34	11-23-340/234
1,34	11-23-340/134	1,85	11-23-340/185	2,35	11-23-340/235
1,35	11-23-340/135	1,86	11-23-340/186	2,36	11-23-340/236
1,36	11-23-340/136	1,88	11-23-340/188	2,38	11-23-340/238
1,38	11-23-340/138	1,90	11-23-340/190	2,40	11-23-340/240
1,40	11-23-340/140	1,92	11-23-340/192	2,42	11-23-340/242
1,42	11-23-340/142	1,94	11-23-340/194	2,44	11-23-340/244
1,44	11-23-340/144	1,95	11-23-340/195	2,45	11-23-340/245
1,45	11-23-340/145	1,96	11-23-340/196	2,46	11-23-340/246
1,46	11-23-340/146	1,98	11-23-340/198	2,48	11-23-340/248
1,48	11-23-340/148	2,00	11-23-340/200	2,50	11-23-340/250
1,50	11-23-340/150				



DENSO

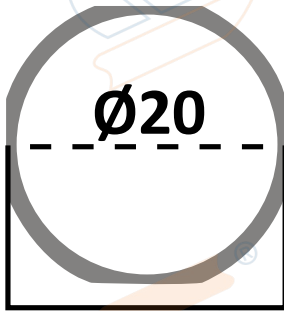
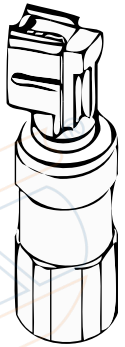

Ø23,2

da 2,990.. a 3,150
 ALTRE MISURE DISPONIBILI A RICHIESTA
 OTHER SIZES AVAILABLE UPON REQUEST
 OTROS TAMAÑOS DISPONIBLES BAJO PETICIÓN
 ДРУГИЕ РАЗМЕРЫ ДОСТУПНЫ ПО ЗАПРОСУ
 根據要求提供其它尺寸

CODICE OMS	SPESSORE	INCREMENTO	N° PEZZI
11-23-341	DA 2,99 A 3,10	0,01	120



HANDBAG | VALIGETTA 12 POSIZIONI | POSITION

CODICE OMS	SPESSORE	INCREMENTO	N° PEZZI
11-23-418	DA 2,99 A 3,15	0,01	170



HANDBAG | VALIGETTA 24 POSIZIONI | POSITION

CODICE OMS	SPESSORE	INCREMENTO	N° PEZZI
11-23-971	DA 2,990 A 3,150	0,004	410

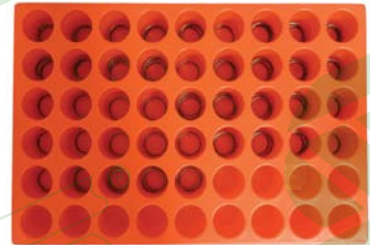

HANDBAG | VALIGETTA 54 POSIZIONI | POSITION

CODICE SINGOLI SPESSORI CODE INDIVIDUAL THICKNESSES

MISURA	COD. OMS
2,99	11-23-341/299
3,00	11-23-341/300
3,01	11-23-341/301
3,02	11-23-341/302
3,03	11-23-341/303
3,04	11-23-341/304
3,05	11-23-341/305
3,06	11-23-341/306
3,07	11-23-341/307
3,08	11-23-341/308
3,09	11-23-341/309
3,10	11-23-341/310
3,11	11-23-341/311
3,12	11-23-341/312
3,13	11-23-341/313
3,14	11-23-341/314
3,15	11-23-341/315

CODICE SINGOLI SPESSORI CODE INDIVIDUAL THICKNESSES

MISURA	COD. OMS	MISURA	COD. OMS
2,990	11-23-971/2990	3,074	11-23-971/3074
2,994	11-23-971/2994	3,078	11-23-971/3078
2,998	11-23-971/2998	3,082	11-23-971/3082
3,002	11-23-971/3002	3,086	11-23-971/3086
3,006	11-23-971/3006	3,090	11-23-971/3090
3,010	11-23-971/3010	3,094	11-23-971/3094
3,014	11-23-971/3014	3,098	11-23-971/3098
3,018	11-23-971/3018	3,102	11-23-971/3102
3,022	11-23-971/3022	3,106	11-23-971/3106
3,026	11-23-971/3026	3,110	11-23-971/3110
3,030	11-23-971/3030	3,114	11-23-971/3114
3,034	11-23-971/3034	3,118	11-23-971/3118
3,038	11-23-971/3038	3,122	11-23-971/3122
3,042	11-23-971/3042	3,126	11-23-971/3126
3,046	11-23-971/3046	3,130	11-23-971/3130
3,050	11-23-971/3050	3,134	11-23-971/3134
3,054	11-23-971/3054	3,138	11-23-971/3138
3,058	11-23-971/3058	3,142	11-23-971/3142
3,062	11-23-971/3062	3,146	11-23-971/3146
3,066	11-23-971/3066	3,150	11-23-971/3150
3,070	11-23-971/3070		

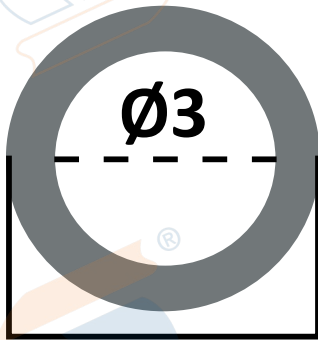
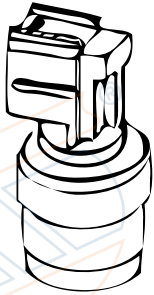

Ø5,8

da 1,00.. a 2,30

ALTRE MISURE DISPONIBILI A RICHIESTA
OTHER SIZES AVAILABLE UPON REQUEST
OTROS TAMAÑOS DISPONIBLES BAJO PETICIÓN
ДРУГИЕ РАЗМЕРЫ ДОСТУПНЫ ПО ЗАПРОСУ
根據要求提供其它尺寸



CODICE OMS	SPESSORE	INCREMENTO	N° PEZZI
11-23-395	DA 1,10 A 1,65	0,05	120
11-23-753	DA 1,75 A 2,30	0,05	120

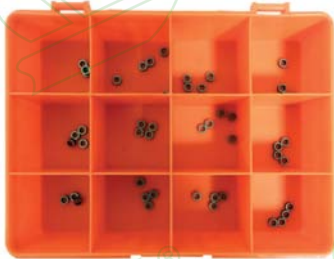

HANDBAG | VALIGETTA **12** POSIZIONI | POSITION

CODICE OMS	SPESSORE	INCREMENTO	N° PEZZI
11-23-416	DA 1,10 A 1,60	0,02	260
11-23-754	DA 1,60 A 2,30	0,02	360



HANDBAG | VALIGETTA **36** POSIZIONI | POSITION



CODICE SINGOLI SPESSORI CODE INDIVIDUAL THICKNESSES

MISURA	COD. OMS	MISURA	COD. OMS
1,00	11-23-395/100	1,66	11-23-395/166
1,02	11-23-395/102	1,68	11-23-395/168
1,04	11-23-395/104	1,70	11-23-395/170
1,05	11-23-395/105	1,72	11-23-395/172
1,06	11-23-395/106	1,74	11-23-395/174
1,08	11-23-395/108	1,75	11-23-395/175
1,10	11-23-395/110	1,76	11-23-395/176
1,12	11-23-395/112	1,78	11-23-395/178
1,14	11-23-395/114	1,80	11-23-395/180
1,15	11-23-395/115	1,82	11-23-395/182
1,16	11-23-395/116	1,84	11-23-395/184
1,18	11-23-395/118	1,85	11-23-395/185
1,20	11-23-395/120	1,86	11-23-395/186
1,22	11-23-395/122	1,88	11-23-395/188
1,24	11-23-395/124	1,90	11-23-395/190
1,25	11-23-395/125	1,92	11-23-395/192
1,26	11-23-395/126	1,94	11-23-395/194
1,28	11-23-395/128	1,95	11-23-395/195
1,30	11-23-395/130	1,96	11-23-395/196
1,32	11-23-395/132	1,98	11-23-395/198
1,34	11-23-395/134	2,00	11-23-395/200
1,35	11-23-395/135	2,02	11-23-395/202
1,36	11-23-395/136	2,04	11-23-395/204
1,38	11-23-395/138	2,05	11-23-395/205
1,40	11-23-395/140	2,06	11-23-395/206
1,42	11-23-395/142	2,08	11-23-395/208
1,44	11-23-395/144	2,10	11-23-395/210
1,45	11-23-395/145	2,12	11-23-395/212
1,46	11-23-395/146	2,14	11-23-395/214
1,48	11-23-395/148	2,15	11-23-395/215
1,50	11-23-395/150	2,16	11-23-395/216
1,52	11-23-395/152	2,18	11-23-395/218
1,54	11-23-395/154	2,20	11-23-395/220
1,55	11-23-395/155	2,22	11-23-395/222
1,56	11-23-395/156	2,24	11-23-395/224
1,58	11-23-395/158	2,25	11-23-395/225
1,60	11-23-395/160	2,26	11-23-395/226
1,62	11-23-395/162	2,28	11-23-395/228
1,64	11-23-395/164	2,30	11-23-395/230
1,65	11-23-395/165		



DENSO

da 1,20.. a 1,75

ALTRE MISURE DISPONIBILI A RICHIESTA
OTHER SIZES AVAILABLE UPON REQUEST
OTROS TAMAÑOS DISPONIBLES BAJO PETICIÓN
ДРУГИЕ РАЗМЕРЫ ДОСТУПНЫ ПО ЗАПРОСУ
根據要求提供其它尺寸

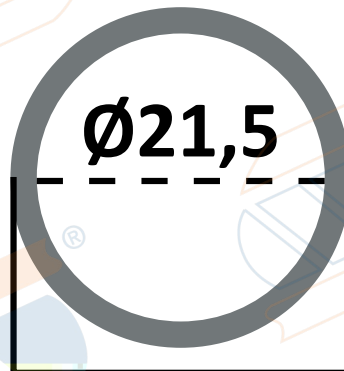
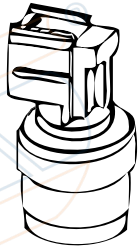

Ø24,3



CODICE SINGOLI SPESSORI CODE INDIVIDUAL THICKNESSES

MISURA	COD. OMS	MISURA	COD. OMS
1,20	11-23-343/120	1,48	11-23-343/148
1,21	11-23-343/121	1,49	11-23-343/149
1,22	11-23-343/122	1,50	11-23-343/150
1,23	11-23-343/123	1,51	11-23-343/151
1,24	11-23-343/124	1,52	11-23-343/152
1,25	11-23-343/125	1,53	11-23-343/153
1,26	11-23-343/126	1,54	11-23-343/154
1,27	11-23-343/127	1,55	11-23-343/155
1,28	11-23-343/128	1,56	11-23-343/156
1,29	11-23-343/129	1,57	11-23-343/157
1,30	11-23-343/130	1,58	11-23-343/158
1,31	11-23-343/131	1,59	11-23-343/159
1,32	11-23-343/132	1,60	11-23-343/160
1,33	11-23-343/133	1,61	11-23-343/161
1,34	11-23-343/134	1,62	11-23-343/162
1,35	11-23-343/135	1,63	11-23-343/163
1,36	11-23-343/136	1,64	11-23-343/164
1,37	11-23-343/137	1,65	11-23-343/165
1,38	11-23-343/138	1,66	11-23-343/166
1,39	11-23-343/139	1,67	11-23-343/167
1,40	11-23-343/140	1,68	11-23-343/168
1,41	11-23-343/141	1,69	11-23-343/169
1,42	11-23-343/142	1,70	11-23-343/170
1,43	11-23-343/143	1,71	11-23-343/171
1,44	11-23-343/144	1,72	11-23-343/172
1,45	11-23-343/145	1,73	11-23-343/173
1,46	11-23-343/146	1,74	11-23-343/174
1,47	11-23-343/147	1,75	11-23-343/175

CODICE OMS	SPESSORE	INCREMENTO	N° PEZZI
11-23-343	DA 1,50 A 1,72	0,02	120



HANDBAG | VALIGETTA 12 POSIZIONI | POSITION

CODICE OMS	SPESSORE	INCREMENTO	N° PEZZI
11-23-344	DA 1,50 A 1,72	0,01	230



HANDBAG | VALIGETTA 24 POSIZIONI | POSITION

CODICE OMS	SPESSORE	INCREMENTO	N° PEZZI
11-23-399	DA 1,20 A 1,74	0,02	280

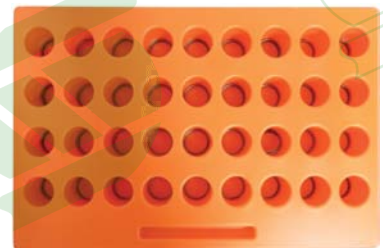

HANDBAG | VALIGETTA 36 POSIZIONI | POSITION

CODICE OMS	SPESSORE	INCREMENTO	N° PEZZI
11-23-400	DA 1,20 A 1,73	0,01	540



HANDBAG | VALIGETTA 54 POSIZIONI | POSITION

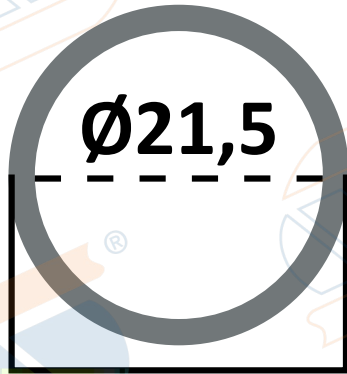
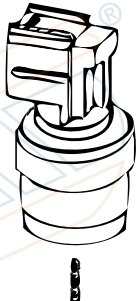

Ø24,3

da 1,435.. a 1,70
 ALTRE MISURE DISPONIBILI A RICHIESTA
 OTHER SIZES AVAILABLE UPON REQUEST
 OTROS TAMAÑOS DISPONIBLES BAJO PETICIÓN
 ДРУГИЕ РАЗМЕРЫ ДОСТУПНЫ ПО ЗАПРОСУ
 根據要求提供其它尺寸

CODICE SINGOLI SPessori
CODE INDIVIDUAL THICKNESSES

MISURA	COD. OMS	MISURA	COD. OMS
1,435	11-23-343/1435	1,57	11-23-343/157
1,44	11-23-343/144	1,575	11-23-343/1575
1,445	11-23-343/1445	1,58	11-23-343/158
1,45	11-23-343/145	1,585	11-23-343/1585
1,455	11-23-343/1455	1,59	11-23-343/159
1,46	11-23-343/146	1,595	11-23-343/1595
1,465	11-23-343/1465	1,60	11-23-343/160
1,47	11-23-343/147	1,605	11-23-343/1605
1,475	11-23-343/1475	1,61	11-23-343/161
1,48	11-23-343/148	1,615	11-23-343/1615
1,485	11-23-343/1485	1,62	11-23-343/162
1,49	11-23-343/149	1,625	11-23-343/1625
1,495	11-23-343/1495	1,63	11-23-343/163
1,50	11-23-343/150	1,635	11-23-343/1635
1,505	11-23-343/1505	1,64	11-23-343/164
1,51	11-23-343/151	1,645	11-23-343/1645
1,515	11-23-343/1515	1,65	11-23-343/165
1,52	11-23-343/152	1,655	11-23-343/1655
1,525	11-23-343/1525	1,66	11-23-343/166
1,53	11-23-343/153	1,665	11-23-343/1665
1,535	11-23-343/1535	1,67	11-23-343/167
1,54	11-23-343/154	1,675	11-23-343/1675
1,545	11-23-343/1545	1,68	11-23-343/168
1,55	11-23-343/155	1,685	11-23-343/1685
1,555	11-23-343/1555	1,69	11-23-343/169
1,56	11-23-343/156	1,695	11-23-343/1695
1,565	11-23-343/1565	1,70	11-23-343/170

CODICE OMS	SPESORE	INCREMENTO	N° PEZZI
11-23-715	DA 1,435 A 1,70	0,005	540



HANDBAG | VALIGETTA 54 POSIZIONI | POSITION



DENSO

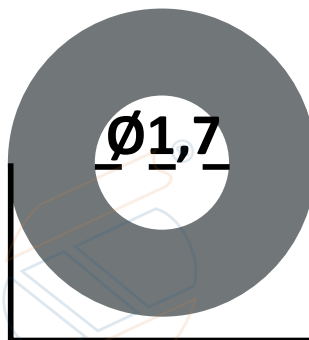
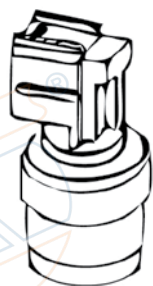

Ø3,95

da 0,95.. a 1,50

ALTRE MISURE DISPONIBILI A RICHIESTA

OTHER SIZES AVAILABLE UPON REQUEST

OTROS TAMAÑOS DISPONIBLES BAJO PETICIÓN

ДРУГИЕ РАЗМЕРЫ ДОСТУПНЫ ПО ЗАПРОСУ

根據要求提供其它尺寸

CODICE OMS	SPESSORE	INCREMENTO	N° PEZZI
11-23-843	DA 0,95 A 1,50	0,05	120

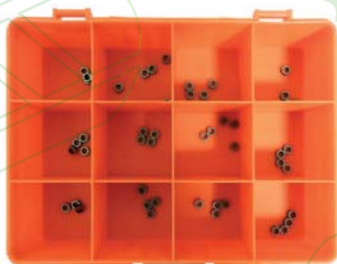

HANDBAG | VALIGETTA **12** POSIZIONI | POSITION

CODICE SINGOLI SPESSORI
CODE INDIVIDUAL THICKNESSES

MISURA	COD. OMS	MISURA	COD. OMS
0,95	11-23-843/095	1,25	11-23-843/125
1,00	11-23-843/100	1,30	11-23-843/130
1,05	11-23-843/105	1,35	11-23-843/135
1,10	11-23-843/110	1,40	11-23-843/140
1,15	11-23-843/115	1,45	11-23-843/145
1,20	11-23-843/120	1,50	11-23-843/150

CODICE OMS	SPESSORE	INCREMENTO	N° PEZZI
11-23-844	DA 0,98 A 1,44	0,02	240

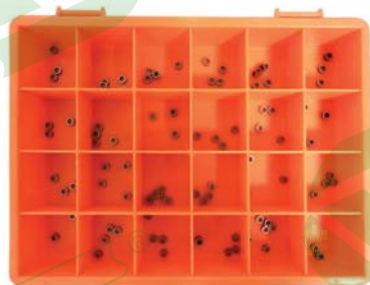

HANDBAG | VALIGETTA **24** POSIZIONI | POSITION

CODICE SINGOLI SPESSORI
CODE INDIVIDUAL THICKNESSES

MISURA	COD. OMS	MISURA	COD. OMS
0,98	11-23-844/098	1,22	11-23-844/122
1,00	11-23-844/100	1,24	11-23-844/124
1,02	11-23-844/102	1,26	11-23-844/126
1,04	11-23-844/104	1,28	11-23-844/128
1,06	11-23-844/106	1,30	11-23-844/130
1,08	11-23-844/108	1,32	11-23-844/132
1,10	11-23-844/110	1,34	11-23-844/134
1,12	11-23-844/112	1,36	11-23-844/136
1,14	11-23-844/114	1,38	11-23-844/138
1,16	11-23-844/116	1,40	11-23-844/140
1,18	11-23-844/118	1,42	11-23-844/142
1,20	11-23-844/120	1,44	11-23-844/144



DENSO

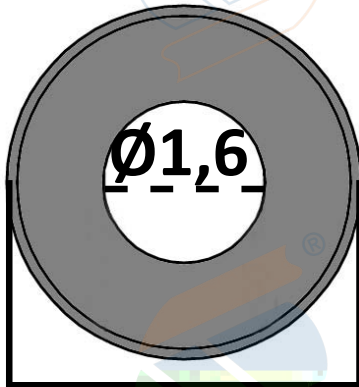

Ø3,95



da 1,00.. a 2,00

ALTRE MISURE DISPONIBILI A RICHIESTA

OTHER SIZES AVAILABLE UPON REQUEST

OTROS TAMAÑOS DISPONIBLES BAJO PETICIÓN

ДРУГИЕ РАЗМЕРЫ ДОСТУПНЫ ПО ЗАПРОСУ

根據要求提供其它尺寸

CODICE OMS	SPESORE	INCREMENTO	N° PEZZI
11-23-947	DA 1,00 A 2,00	0,05	210

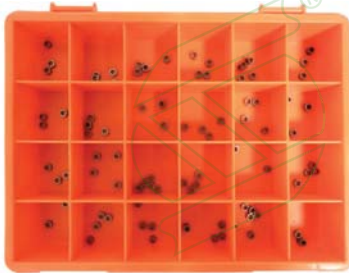

HANDBAG | VALIGETTA 24 POSIZIONI | POSITION

CODICE OMS	SPESORE	INCREMENTO	N° PEZZI
11-23-946	DA 1,00 A 1,70	0,02	360



HANDBAG | VALIGETTA 36 POSIZIONI | POSITION

CODICE SINGOLI SPessori CODE INDIVIDUAL THICKNESSES

MISURA	COD. OMS	MISURA	COD. OMS
1,00	11-23-946/100	1,42	11-23-946/142
1,02	11-23-946/102	1,44	11-23-946/144
1,04	11-23-946/104	1,45	11-23-946/145
1,05	11-23-946/105	1,46	11-23-946/146
1,06	11-23-946/106	1,48	11-23-946/148
1,08	11-23-946/108	1,50	11-23-946/150
1,10	11-23-946/110	1,52	11-23-946/152
1,12	11-23-946/112	1,54	11-23-946/154
1,14	11-23-946/114	1,55	11-23-946/155
1,15	11-23-946/115	1,56	11-23-946/156
1,16	11-23-946/116	1,58	11-23-946/158
1,18	11-23-946/118	1,60	11-23-946/160
1,20	11-23-946/120	1,62	11-23-946/162
1,22	11-23-946/122	1,64	11-23-946/164
1,24	11-23-946/124	1,65	11-23-946/165
1,25	11-23-946/125	1,66	11-23-946/166
1,26	11-23-946/126	1,68	11-23-946/168
1,28	11-23-946/128	1,70	11-23-946/170
1,30	11-23-946/130	1,75	11-23-946/175
1,32	11-23-946/132	1,80	11-23-946/180
1,34	11-23-946/134	1,85	11-23-946/185
1,35	11-23-946/135	1,90	11-23-946/190
1,36	11-23-946/136	1,95	11-23-946/195
1,38	11-23-946/138	2,00	11-23-946/200
1,40	11-23-946/140		



DENSO

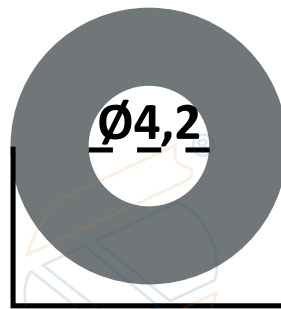

Ø6,4

da 1,20.. a 1,90

ALTRE MISURE DISPONIBILI A RICHIESTA

OTHER SIZES AVAILABLE UPON REQUEST

OTROS TAMAÑOS DISPONIBLES BAJO PETICIÓN

ДРУГИЕ РАЗМЕРЫ ДОСТУПНЫ ПО ЗАПРОСУ

根據要求提供其它尺寸



CODICE SINGOLI SPessori					
CODE INDIVIDUAL THICKNESSES					
MISURA	cod. OMS	MISURA	cod. OMS	MISURA	cod. OMS
1,20	11-23-948/120	1,44	11-23-948/144	1,68	11-23-948/168
1,22	11-23-948/122	1,46	11-23-948/146	1,70	11-23-948/170
1,24	11-23-948/124	1,48	11-23-948/148	1,72	11-23-948/172
1,26	11-23-948/126	1,50	11-23-948/150	1,74	11-23-948/174
1,28	11-23-948/128	1,52	11-23-948/152	1,76	11-23-948/176
1,30	11-23-948/130	1,54	11-23-948/154	1,78	11-23-948/178
1,32	11-23-948/132	1,56	11-23-948/156	1,80	11-23-948/180
1,34	11-23-948/134	1,58	11-23-948/158	1,82	11-23-948/182
1,36	11-23-948/136	1,60	11-23-948/160	1,84	11-23-948/184
1,38	11-23-948/138	1,62	11-23-948/162	1,86	11-23-948/186
1,40	11-23-948/140	1,64	11-23-948/164	1,88	11-23-948/188
1,42	11-23-948/142	1,66	11-23-948/166	1,90	11-23-948/190



Ø24,95

da 1,396.. a 1,716

ALTRE MISURE DISPONIBILI A RICHIESTA
 OTHER SIZES AVAILABLE UPON REQUEST
 OTROS TAMAÑOS DISPONIBLES BAJO PETICIÓN
 ДРУГИЕ РАЗМЕРЫ ДОСТУПНЫ ПО ЗАПРОСУ
 根據要求提供其它尺寸

CODICE OMS	SPESORE	INCREMENTO	N° PEZZI
11-23-950	DA 1,396 A 1,716	0,004	810



HANDBAG | VALIGETTA 96 POSIZIONI | POSITION

**CODICE SINGOLI SPESSORI
 CODE INDIVIDUAL THICKNESSES**

MISURA	cod. OMS	MISURA	cod. OMS
1,396	11-23-950/1396	1,560	11-23-950/1560
1,40	11-23-950/1400	1,564	11-23-950/1564
1,404	11-23-950/1404	1,568	11-23-950/1568
1,408	11-23-950/1408	1,572	11-23-950/1572
1,412	11-23-950/1412	1,576	11-23-950/1576
1,416	11-23-950/1416	1,580	11-23-950/1580
1,420	11-23-950/1420	1,584	11-23-950/1584
1,424	11-23-950/1424	1,588	11-23-950/1588
1,428	11-23-950/1428	1,592	11-23-950/1592
1,432	11-23-950/1432	1,596	11-23-950/1596
1,436	11-23-950/1436	1,60	11-23-950/1600
1,440	11-23-950/1440	1,604	11-23-950/1604
1,444	11-23-950/1444	1,608	11-23-950/1608
1,448	11-23-950/1448	1,612	11-23-950/1612
1,452	11-23-950/1452	1,616	11-23-950/1616
1,456	11-23-950/1456	1,620	11-23-950/1620
1,460	11-23-950/1460	1,624	11-23-950/1624
1,464	11-23-950/1464	1,628	11-23-950/1628
1,468	11-23-950/1468	1,632	11-23-950/1632
1,472	11-23-950/1472	1,636	11-23-950/1636
1,476	11-23-950/1476	1,640	11-23-950/1640
1,480	11-23-950/1480	1,644	11-23-950/1644
1,484	11-23-950/1484	1,648	11-23-950/1648
1,488	11-23-950/1488	1,652	11-23-950/1652
1,492	11-23-950/1492	1,656	11-23-950/1656
1,496	11-23-950/1496	1,660	11-23-950/1660
1,50	11-23-950/1500	1,664	11-23-950/1664
1,504	11-23-950/1504	1,668	11-23-950/1668
1,508	11-23-950/1508	1,672	11-23-950/1672
1,512	11-23-950/1512	1,676	11-23-950/1676
1,516	11-23-950/1516	1,680	11-23-950/1680
1,520	11-23-950/1520	1,684	11-23-950/1684
1,524	11-23-950/1524	1,688	11-23-950/1688
1,528	11-23-950/1528	1,692	11-23-950/1692
1,532	11-23-950/1532	1,696	11-23-950/1696
1,536	11-23-950/1536	1,70	11-23-950/1700
1,540	11-23-950/1540	1,704	11-23-950/1704
1,544	11-23-950/1544	1,708	11-23-950/1708
1,548	11-23-950/1548	1,712	11-23-950/1712
1,552	11-23-950/1552	1,716	11-23-950/1716
1,556	11-23-950/1556		



VARI



COMMON RAIL

VARI - VARIOUS

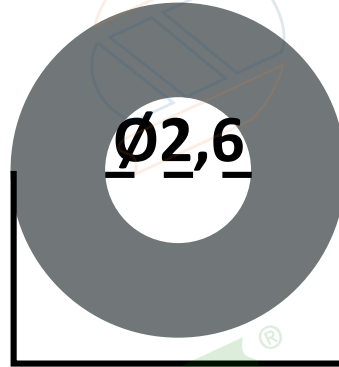

Ø6,2

da 0,40.. a 1,20

ALTRE MISURE DISPONIBILI A RICHIESTA

OTHER SIZES AVAILABLE UPON REQUEST

OTROS TAMAÑOS DISPONIBLES BAJO PETICIÓN

ДРУГИЕ РАЗМЕРЫ ДОСТУПНЫ ПО ЗАПРОСУ

根據要求提供其它尺寸

CODICE SINGOLI SPESSORI
CODE INDIVIDUAL THICKNESSES

MISURA	COD. OMS
0,40	02-35-040
0,50	02-35-050
0,52	02-35-052
0,54	02-35-054
0,56	02-35-056
0,58	02-35-058
0,60	02-35-060
0,70	02-35-070
1,20	02-35-120



VARI - VARIOUS

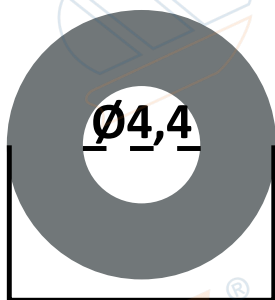

Ø8,9

da 0,50.. a 1,98

ALTRE MISURE DISPONIBILI A RICHIESTA

OTHER SIZES AVAILABLE UPON REQUEST

OTROS TAMAÑOS DISPONIBLES BAJO PETICIÓN

ДРУГИЕ РАЗМЕРЫ ДОСТУПНЫ ПО ЗАПРОСУ

根據要求提供其它尺寸

CODICE SINGOLI SPESSORI
CODE INDIVIDUAL THICKNESSES

MISURA	COD. OMS	MISURA	COD. OMS
0,50	02-30-050	1,26	02-30-126
0,52	02-30-052	1,28	02-30-128
0,54	02-30-054	1,30	02-30-130
0,56	02-30-056	1,32	02-30-132
0,58	02-30-058	1,34	02-30-134
0,60	02-30-060	1,36	02-30-136
0,62	02-30-062	1,38	02-30-138
0,64	02-30-064	1,40	02-30-140
0,66	02-30-066	1,42	02-30-142
0,68	02-30-068	1,44	02-30-144
0,70	02-30-070	1,46	02-30-146
0,72	02-30-072	1,48	02-30-148
0,74	02-30-074	1,50	02-30-150
0,76	02-30-076	1,52	02-30-152
0,78	02-30-078	1,54	02-30-154
0,80	02-30-080	1,56	02-30-156
0,82	02-30-082	1,58	02-30-158
0,84	02-30-084	1,60	02-30-160
0,86	02-30-086	1,62	02-30-162
0,88	02-30-088	1,64	02-30-164
0,90	02-30-090	1,66	02-30-166
0,92	02-30-092	1,68	02-30-168
0,94	02-30-094	1,70	02-30-170
0,96	02-30-096	1,72	02-30-172
0,98	02-30-098	1,74	02-30-174
1,00	02-30-100	1,76	02-30-176
1,02	02-30-102	1,78	02-30-178
1,04	02-30-104	1,80	02-30-180
1,06	02-30-106	1,82	02-30-182
1,08	02-30-108	1,84	02-30-184
1,12	02-30-112	1,86	02-30-186
1,14	02-30-114	1,88	02-30-188
1,16	02-30-116	1,90	02-30-190
1,18	02-30-118	1,92	02-30-192
1,20	02-30-120	1,94	02-30-194
1,22	02-30-122	1,96	02-30-196
1,24	02-30-124	1,98	02-30-198



COMMON RAIL

BOSCH POMPA ROTATIVA

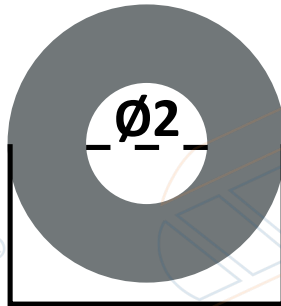
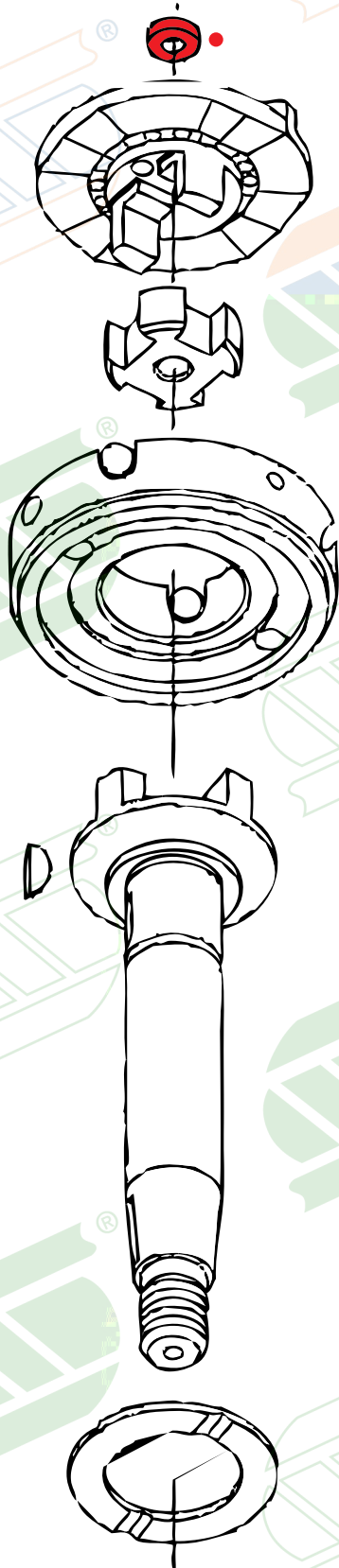

Ø9,5



HANDBAG | VALIGETTA 54 POSIZIONI | POSITION

da 1,78.. a 2,90

ALTRE MISURE DISPONIBILI A RICHIESTA
OTHER SIZES AVAILABLE UPON REQUEST
OTROS TAMAÑOS DISPONIBLES BAJO PETICIÓN
ДРУГИЕ РАЗМЕРЫ ДОСТУПНЫ ПО ЗАПРОСУ
根據要求提供其它尺寸

CODICE SINGOLI SPESSORI CODE INDIVIDUAL THICKNESSES

MISURA	RIF. ORIGINALE	COD. OMS	MISURA	RIF. ORIGINALE	COD. OMS
1,78	1 460 100 708	02-33-178	2,36	1 460 100 680	02-33-236
1,80	1 460 100 709	02-33-180	2,38	1 460 100 681	02-33-238
1,82	1 460 100 710	02-33-182	2,40	1 460 100 682	02-33-240
1,84	1 460 100 711	02-33-184	2,42	1 460 100 683	02-33-242
1,86	1 460 100 712	02-33-186	2,44	1 460 100 684	02-33-244
1,88	1 460 100 713	02-33-188	2,46	1 460 100 685	02-33-246
1,90	1 460 100 657	02-33-190	2,48	1 460 100 686	02-33-248
1,92	1 460 100 658	02-33-192	2,50	1 460 100 687	02-33-250
1,94	1 460 100 659	02-33-194	2,52	1 460 100 688	02-33-252
1,96	1 460 100 660	02-33-196	2,54	1 460 100 689	02-33-254
1,98	1 460 100 661	02-33-198	2,56	1 460 100 690	02-33-256
2,00	1 460 100 662	02-33-200	2,58	1 460 100 691	02-33-258
2,02	1 460 100 663	02-33-202	2,60	1 460 100 692	02-33-260
2,04	1 460 100 664	02-33-204	2,62	1 460 100 693	02-33-262
2,06	1 460 100 665	02-33-206	2,64	1 460 100 694	02-33-264
2,08	1 460 100 666	02-33-208	2,66	1 460 100 695	02-33-266
2,10	1 460 100 667	02-33-210	2,68	1 460 100 696	02-33-268
2,12	1 460 100 668	02-33-212	2,70	1 460 100 697	02-33-270
2,14	1 460 100 669	02-33-214	2,72	1 460 100 698	02-33-272
2,16	1 460 100 670	02-33-216	2,74	1 460 100 699	02-33-274
2,18	1 460 100 671	02-33-218	2,76	1 460 100 700	02-33-276
2,20	1 460 100 672	02-33-220	2,78	1 460 100 701	02-33-278
2,22	1 460 100 673	02-33-222	2,80	1 460 100 702	02-33-280
2,24	1 460 100 674	02-33-224	2,82	1 460 100 703	02-33-282
2,26	1 460 100 675	02-33-226	2,84	1 460 100 704	02-33-284
2,28	1 460 100 676	02-33-228	2,86	1 460 100 705	02-33-286
2,30	1 460 100 677	02-33-230	2,88	1 460 100 706	02-33-288
2,32	1 460 100 678	02-33-232	2,90	1 460 100 707	02-33-290
2,34	1 460 100 679	02-33-234			



VARI - VARIOUS

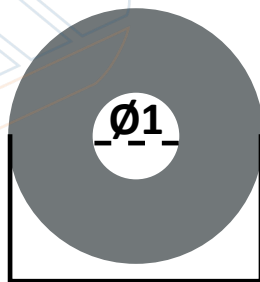

Ø6,3

da 1,00.. a 2,00

ALTRE MISURE DISPONIBILI A RICHIESTA

OTHER SIZES AVAILABLE UPON REQUEST

OTROS TAMAÑOS DISPONIBLES BAJO PETICIÓN

ДРУГИЕ РАЗМЕРЫ ДОСТУПНЫ ПО ЗАПРОСУ

根據要求提供其它尺寸



CODICE SINGOLI SPESSORI
CODE INDIVIDUAL THICKNESSES

MISURA	COD. OMS	MISURA	COD. OMS	MISURA	COD. OMS
1,00	02-20-018/100	1,33	02-20-018/133	1,65	02-20-018/165
1,01	02-20-018/101	1,34	02-20-018/134	1,66	02-20-018/166
1,02	02-20-018/102	1,35	02-20-018/135	1,67	02-20-018/167
1,03	02-20-018/103	1,36	02-20-018/136	1,68	02-20-018/168
1,04	02-20-018/104	1,37	02-20-018/137	1,69	02-20-018/169
1,05	02-20-018/105	1,38	02-20-018/138	1,70	02-20-018/170
1,06	02-20-018/106	1,39	02-20-018/139	1,71	02-20-018/171
1,07	02-20-018/107	1,40	02-20-018/140	1,72	02-20-018/172
1,08	02-20-018/108	1,41	02-20-018/141	1,73	02-20-018/173
1,09	02-20-018/109	1,42	02-20-018/142	1,74	02-20-018/174
1,10	02-20-018/110	1,43	02-20-018/143	1,75	02-20-018/175
1,11	02-20-018/111	1,44	02-20-018/144	1,76	02-20-018/176
1,12	02-20-018/112	1,45	02-20-018/145	1,77	02-20-018/177
1,13	02-20-018/113	1,46	02-20-018/146	1,78	02-20-018/178
1,14	02-20-018/114	1,47	02-20-018/147	1,79	02-20-018/179
1,15	02-20-018/115	1,48	02-20-018/148	1,80	02-20-018/180
1,16	02-20-018/116	1,49	02-20-018/149	1,81	02-20-018/181
1,17	02-20-018/117	1,50	02-20-018/150	1,82	02-20-018/182
1,18	02-20-018/118	1,51	02-20-018/151	1,83	02-20-018/183
1,19	02-20-018/119	1,52	02-20-018/152	1,84	02-20-018/184
1,20	02-20-018/120	1,53	02-20-018/153	1,85	02-20-018/185
1,21	02-20-018/121	1,54	02-20-018/154	1,86	02-20-018/186
1,22	02-20-018/122	1,55	02-20-018/155	1,87	02-20-018/187
1,23	02-20-018/123	1,56	02-20-018/156	1,88	02-20-018/188
1,24	02-20-018/124	1,57	02-20-018/157	1,89	02-20-018/189
1,25	02-20-018/125	1,58	02-20-018/158	1,90	02-20-018/190
1,26	02-20-018/126	1,59	02-20-018/159	1,91	02-20-018/191
1,27	02-20-018/127	1,60	02-20-018/160	1,92	02-20-018/192
1,28	02-20-018/128	1,61	02-20-018/161	1,93	02-20-018/193
1,29	02-20-018/129	1,62	02-20-018/162	1,94	02-20-018/194
1,30	02-20-018/130	1,63	02-20-018/163	1,95	02-20-018/195
1,31	02-20-018/131	1,64	02-20-018/164	2,00	02-20-018/200
1,32	02-20-018/132				



ZEXEL POMPA ROTATIVA

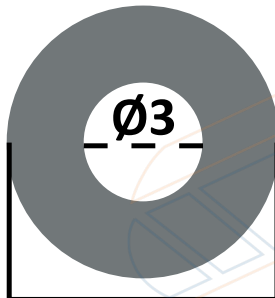
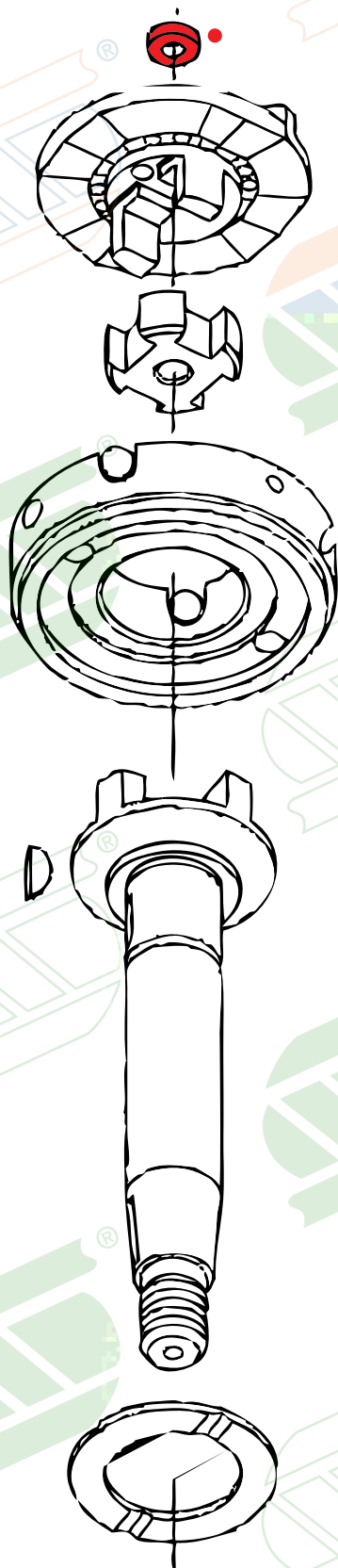

Ø9,5



da 1,74.. a 2,90

ALTRE MISURE DISPONIBILI A RICHIESTA

OTHER SIZES AVAILABLE UPON REQUEST

OTROS TAMAÑOS DISPONIBLES BAJO PETICIÓN

ДРУГИЕ РАЗМЕРЫ ДОСТУПНЫ ПО ЗАПРОСУ

根據要求提供其它尺寸

CODICE SINGOLI SPESSORI CODE INDIVIDUAL THICKNESSES

MISURA	RIF. ORIGINALE	COD. OMS	MISURA	RIF. ORIGINALE	COD. OMS
1,74	9 461 610 228	02-34-174	2,34	9 461 610 199	02-34-234
1,76	9 461 610 229	02-34-176	2,36	9 461 610 200	02-34-236
1,78	9 461 610 230	02-34-178	2,38	9 461 610 201	02-34-238
1,80	9 461 610 231	02-34-180	2,40	9 461 610 202	02-34-240
1,82	9 461 610 232	02-34-182	2,42	9 461 610 203	02-34-242
1,84	9 461 610 233	02-34-184	2,44	9 461 610 204	02-34-244
1,86	9 461 610 234	02-34-186	2,46	9 461 610 205	02-34-246
1,88	9 461 610 235	02-34-188	2,48	9 461 610 206	02-34-248
1,90	9 461 610 177	02-34-190	2,50	9 461 610 207	02-34-250
1,92	9 461 610 178	02-34-192	2,52	9 461 610 208	02-34-252
1,94	9 461 610 179	02-34-194	2,54	9 461 610 209	02-34-254
1,96	9 461 610 180	02-34-196	2,56	9 461 610 210	02-34-256
1,98	9 461 610 181	02-34-198	2,58	9 461 610 211	02-34-258
2,00	9 461 610 182	02-34-200	2,60	9 461 610 212	02-34-260
2,02	9 461 610 183	02-34-202	2,62	9 461 610 213	02-34-262
2,04	9 461 610 184	02-34-204	2,64	9 461 610 214	02-34-264
2,06	9 461 610 185	02-34-206	2,66	9 461 610 215	02-34-266
2,08	9 461 610 186	02-34-208	2,68	9 461 610 216	02-34-268
2,10	9 461 610 187	02-34-210	2,70	9 461 610 217	02-34-270
2,12	9 461 610 188	02-34-212	2,72	9 461 610 218	02-34-272
2,14	9 461 610 189	02-34-214	2,74	9 461 610 219	02-34-274
2,16	9 461 610 190	02-34-216	2,76	9 461 610 220	02-34-276
2,18	9 461 610 191	02-34-218	2,78	9 461 610 221	02-34-278
2,20	9 461 610 192	02-34-220	2,80	9 461 610 222	02-34-280
2,22	9 461 610 193	02-34-222	2,82	9 461 610 223	02-34-282
2,24	9 461 610 194	02-34-224	2,84	9 461 610 224	02-34-284
2,26	9 461 610 195	02-34-226	2,86	9 461 610 225	02-34-286
2,28	9 461 610 196	02-34-228	2,88	9 461 610 226	02-34-288
2,30	9 461 610 197	02-34-230	2,90	9 461 610 227	02-34-290
2,32	9 461 610 198	02-34-232			

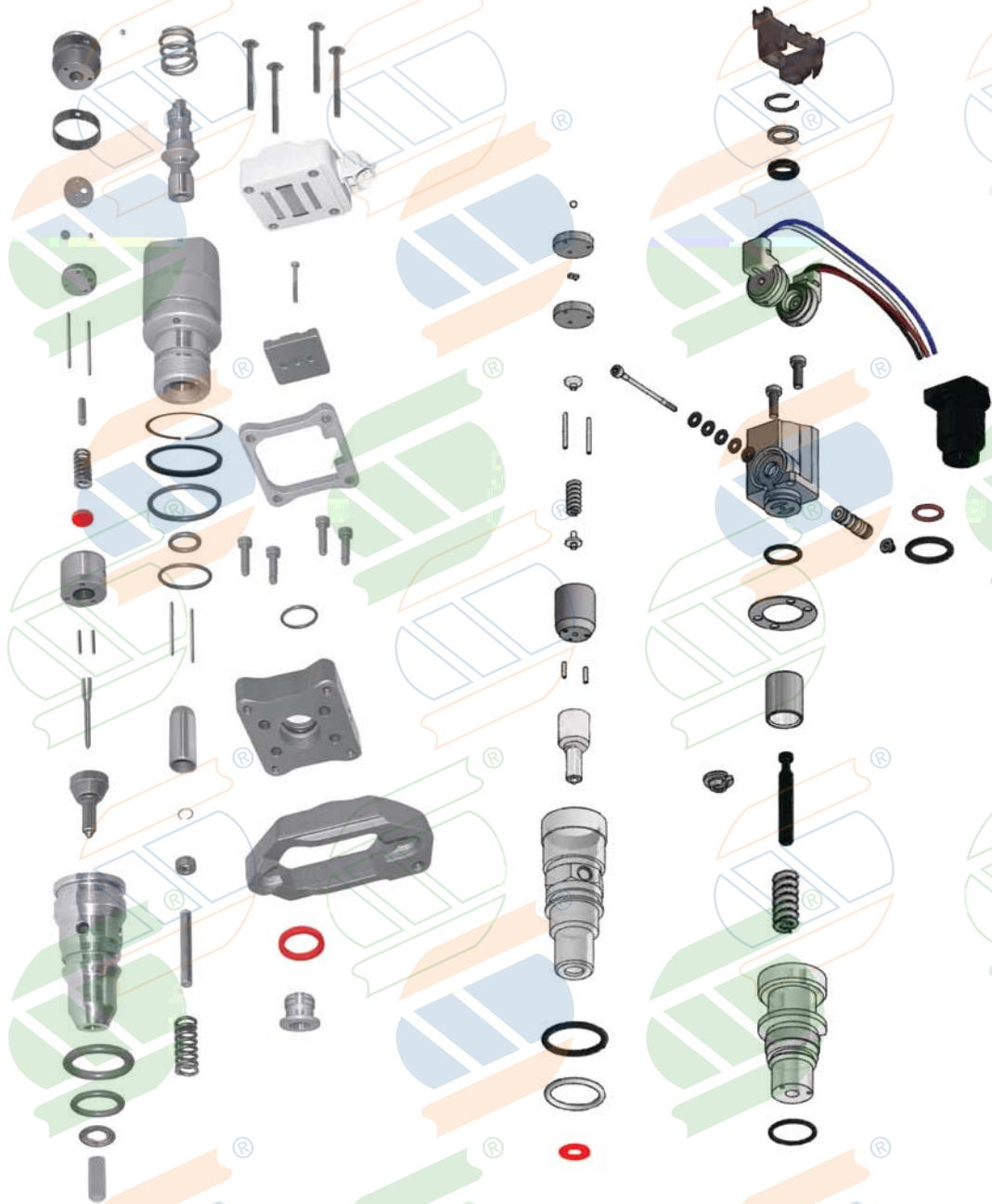

NAVISTAR



NAVISTAR POWERSTROKE 7.3 & MORE

Ø16,5

Ø21,7

da 2,00.. a 2,23

ALTRE MISURE DISPONIBILI A RICHIESTA
OTHER SIZES AVAILABLE UPON REQUEST
OTROS TAMAÑOS DISPONIBLES BAJO PETICIÓN
ДРУГИЕ РАЗМЕРЫ ДОСТУПНЫ ПО ЗАПРОСУ
根據要求提供其它尺寸

CODICE OMS	SPESSORE	INCREMENTO	N° PEZZI
11-23-647	DA 2,00 A 2,23	0,01	240



HANDBAG | VALIGETTA 24 POSIZIONI | POSITION

CODICE SINGOLI SPESSORI CODE INDIVIDUAL THICKNESSES

MISURA	COD. OMS	MISURA	COD. OMS
2,00	11-23-647/200	2,12	11-23-647/212
2,01	11-23-647/201	2,13	11-23-647/213
2,02	11-23-647/202	2,14	11-23-647/214
2,03	11-23-647/203	2,15	11-23-647/215
2,04	11-23-647/204	2,16	11-23-647/216
2,05	11-23-647/205	2,17	11-23-647/217
2,06	11-23-647/206	2,18	11-23-647/218
2,07	11-23-647/207	2,19	11-23-647/219
2,08	11-23-647/208	2,20	11-23-647/220
2,09	11-23-647/209	2,21	11-23-647/221
2,10	11-23-647/210	2,22	11-23-647/222
2,11	11-23-647/211	2,23	11-23-647/223



NAVISTAR POWERSTROKE 7.3 & MORE

***SUITABLE FOR CATERPILLAR 3126 HEUI**

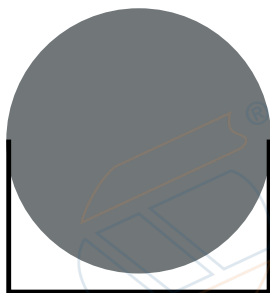

Ø8,9

da 2,00.. a 2,47

ALTRE MISURE DISPONIBILI A RICHIESTA
OTHER SIZES AVAILABLE UPON REQUEST
OTROS TAMAÑOS DISPONIBLES BAJO PETICIÓN
ДРУГИЕ РАЗМЕРЫ ДОСТУПНЫ ПО ЗАПРОСУ
根據要求提供其它尺寸

CODICE OMS	SPESORE	INCREMENTO	N° PEZZI
11-23-648	DA 2,00 A 2,47	0,01	480

HANDBAG | VALIGETTA 54 POSIZIONI | POSITION

CODICE SINGOLI SPessori CODE INDIVIDUAL THICKNESSES

MISURA	COD. OMS	MISURA	COD. OMS
2,00	11-23-648/200	2,24	11-23-648/224
2,01	11-23-648/201	2,25	11-23-648/225
2,02	11-23-648/202	2,26	11-23-648/226
2,03	11-23-648/203	2,27	11-23-648/227
2,04	11-23-648/204	2,28	11-23-648/228
2,05	11-23-648/205	2,29	11-23-648/229
2,06	11-23-648/206	2,30	11-23-648/230
2,07	11-23-648/207	2,31	11-23-648/231
2,08	11-23-648/208	2,32	11-23-648/232
2,09	11-23-648/209	2,33	11-23-648/233
2,10	11-23-648/210	2,34	11-23-648/234
2,11	11-23-648/211	2,35	11-23-648/235
2,12	11-23-648/212	2,36	11-23-648/236
2,13	11-23-648/213	2,37	11-23-648/237
2,14	11-23-648/214	2,38	11-23-648/238
2,15	11-23-648/215	2,39	11-23-648/239
2,16	11-23-648/216	2,40	11-23-648/240
2,17	11-23-648/217	2,41	11-23-648/241
2,18	11-23-648/218	2,42	11-23-648/242
2,19	11-23-648/219	2,43	11-23-648/243
2,20	11-23-648/220	2,44	11-23-648/244
2,21	11-23-648/221	2,45	11-23-648/245
2,22	11-23-648/222	2,46	11-23-648/246
2,23	11-23-648/223	2,47	11-23-648/247

NAVISTAR POWERSTROKE 6.0/4.5 E

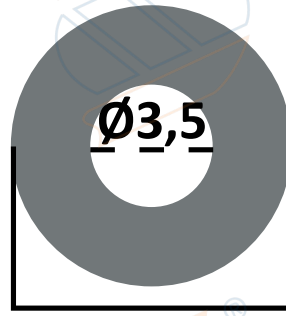

Ø7,35

CODICE OMS	SPESORE	INCREMENTO	N° PEZZI
02-20-035	DA 0,80 A 1,95	0,05	240

HANDBAG | VALIGETTA 24 POSIZIONI | POSITION

da 0,80...a 1,95
 ALTRE MISURE DISPONIBILI A RICHIESTA
 OTHER SIZES AVAILABLE UPON REQUEST
 OTROS TAMAÑOS DISPONIBLES BAJO PETICIÓN
 ДРУГИЕ РАЗМЕРЫ ДОСТУПНЫ ПО ЗАПРОСУ
 根據要求提供其它尺寸

CODICE SINGOLI SPESSORI CODE INDIVIDUAL THICKNESSES			
MISURA	COD. OMS	MISURA	COD. OMS
0,80	02-20-035/080	1,40	02-20-035/140
0,85	02-20-035/085	1,45	02-20-035/145
0,90	02-20-035/090	1,50	02-20-035/150
0,95	02-20-035/095	1,55	02-20-035/155
1,00	02-20-035/100	1,60	02-20-035/160
1,05	02-20-035/105	1,65	02-20-035/165
1,10	02-20-035/110	1,70	02-20-035/170
1,15	02-20-035/115	1,75	02-20-035/175
1,20	02-20-035/120	1,80	02-20-035/180
1,25	02-20-035/125	1,85	02-20-035/185
1,30	02-20-035/130	1,90	02-20-035/190
1,35	02-20-035/135	1,95	02-20-035/195

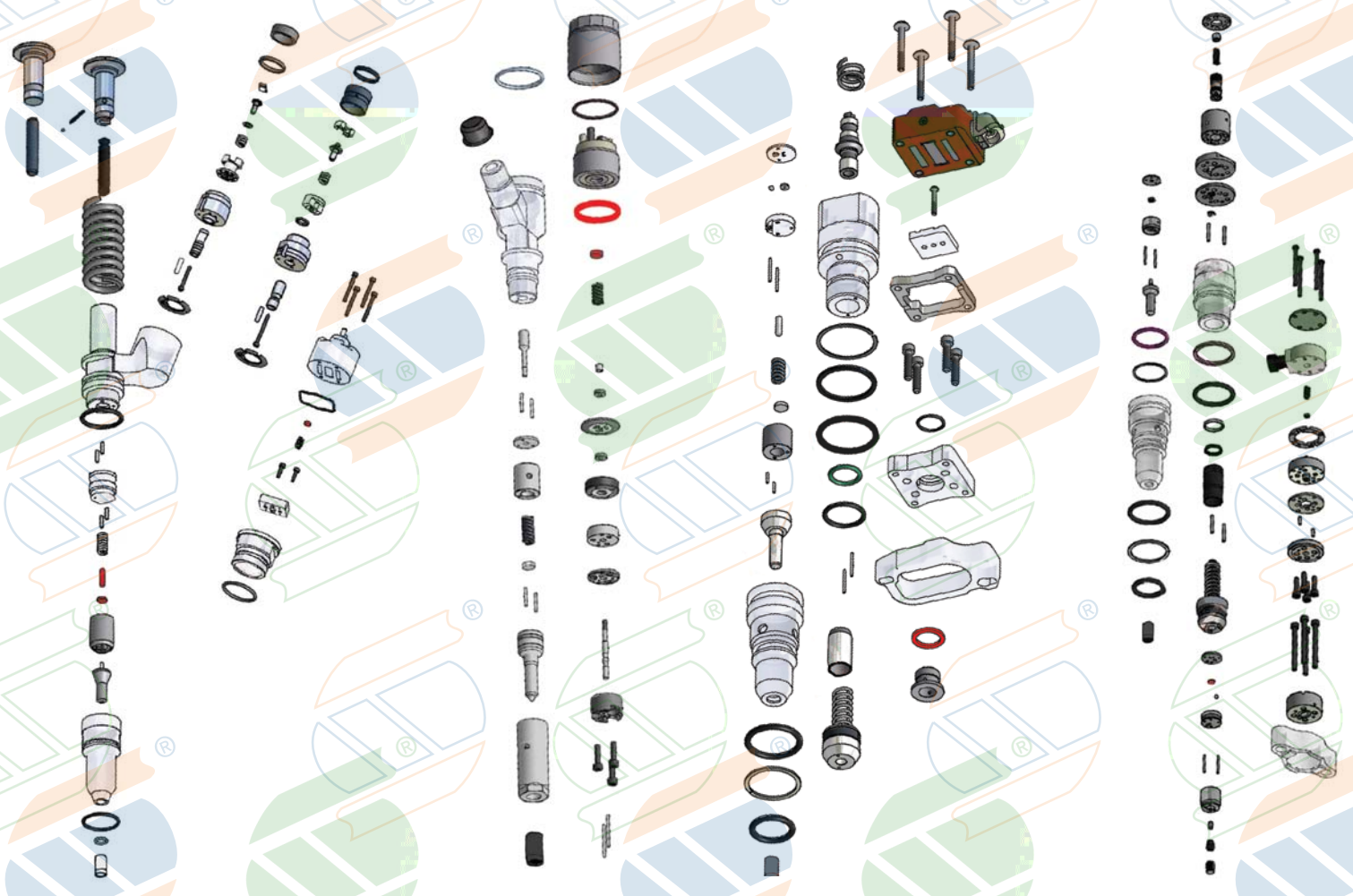
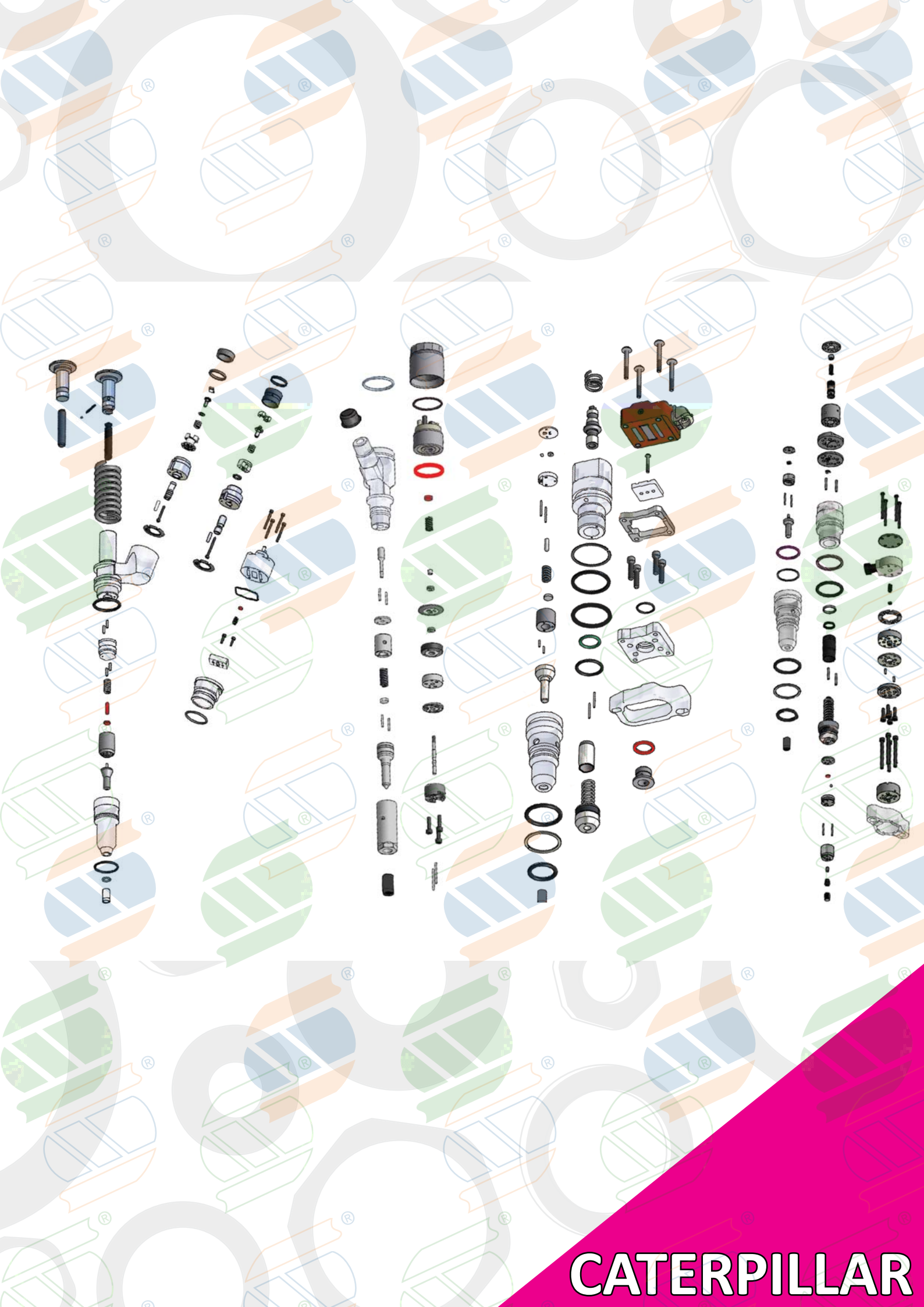

CATERPILLAR

CATERPILLAR 3406 E

da 1,30.. a 2,50

ALTRE MISURE DISPONIBILI A RICHIESTA

OTHER SIZES AVAILABLE UPON REQUEST

OTROS TAMAÑOS DISPONIBLES BAJO PETICIÓN

ДРУГИЕ РАЗМЕРЫ ДОСТУПНЫ ПО ЗАПРОСУ

根據要求提供其它尺寸

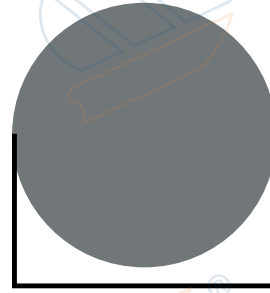

Ø10

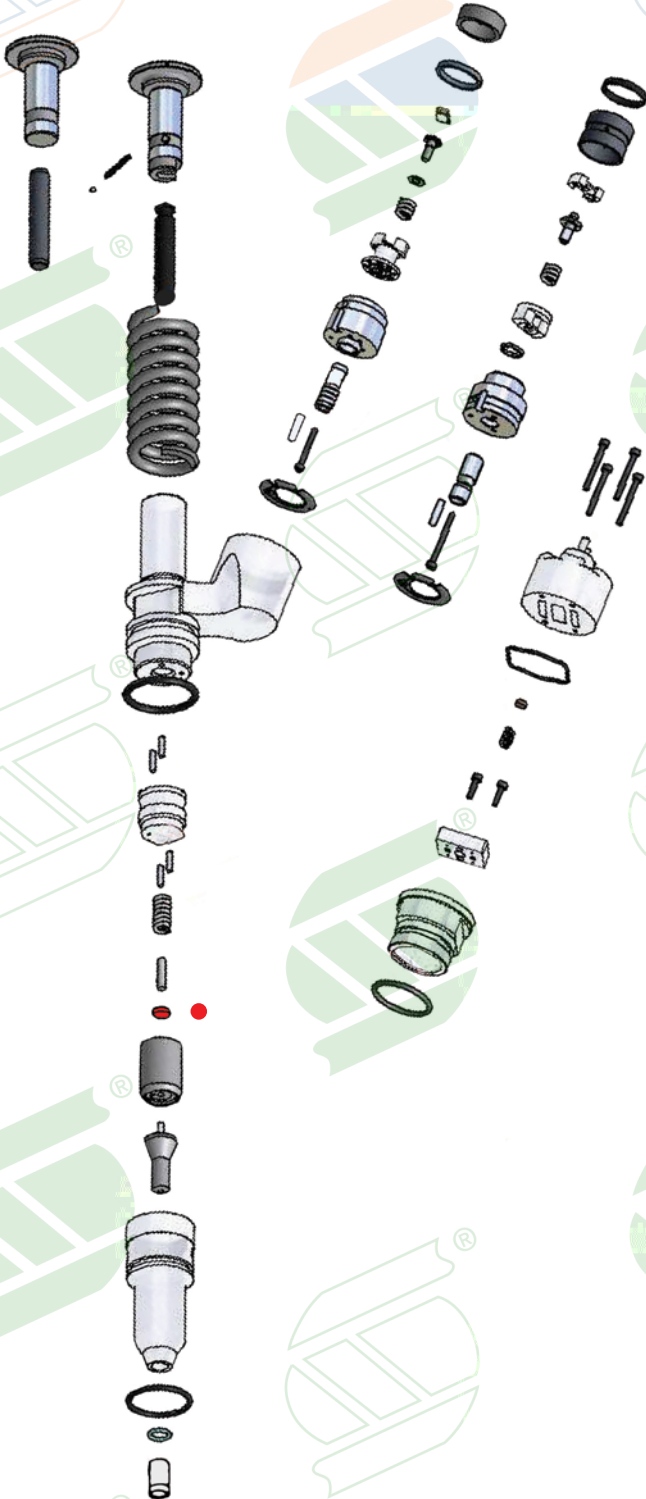

CODICE OMS	SPESORE	INCREMENTO	N° PEZZI
11-23-649	DA 2,00 A 2,50	0,05	110

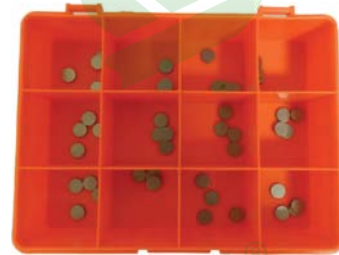

HANDBAG | VALIGETTA 12 POSIZIONI | POSITION

CODICE OMS	SPESORE	INCREMENTO	N° PEZZI
11-23-757	DA 1,30 A 2,50	0,10	130



HANDBAG | VALIGETTA 24 POSIZIONI | POSITION

CODICE SINGOLI SPESSORI CODE INDIVIDUAL THICKNESSES

MISURA	COD. OMS	MISURA	COD. OMS
1,30	11-23-649/130	2,10	11-23-649/210
1,40	11-23-649/140	2,15	11-23-649/215
1,50	11-23-649/150	2,20	11-23-649/220
1,60	11-23-649/160	2,25	11-23-649/225
1,70	11-23-649/170	2,30	11-23-649/230
1,80	11-23-649/180	2,35	11-23-649/235
1,90	11-23-649/190	2,40	11-23-649/240
2,00	11-23-649/200	2,45	11-23-649/245
2,05	11-23-649/205	2,50	11-23-649/250



CATERPILLAR 3406 E

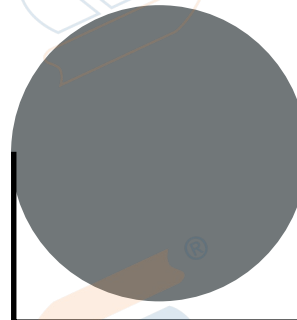
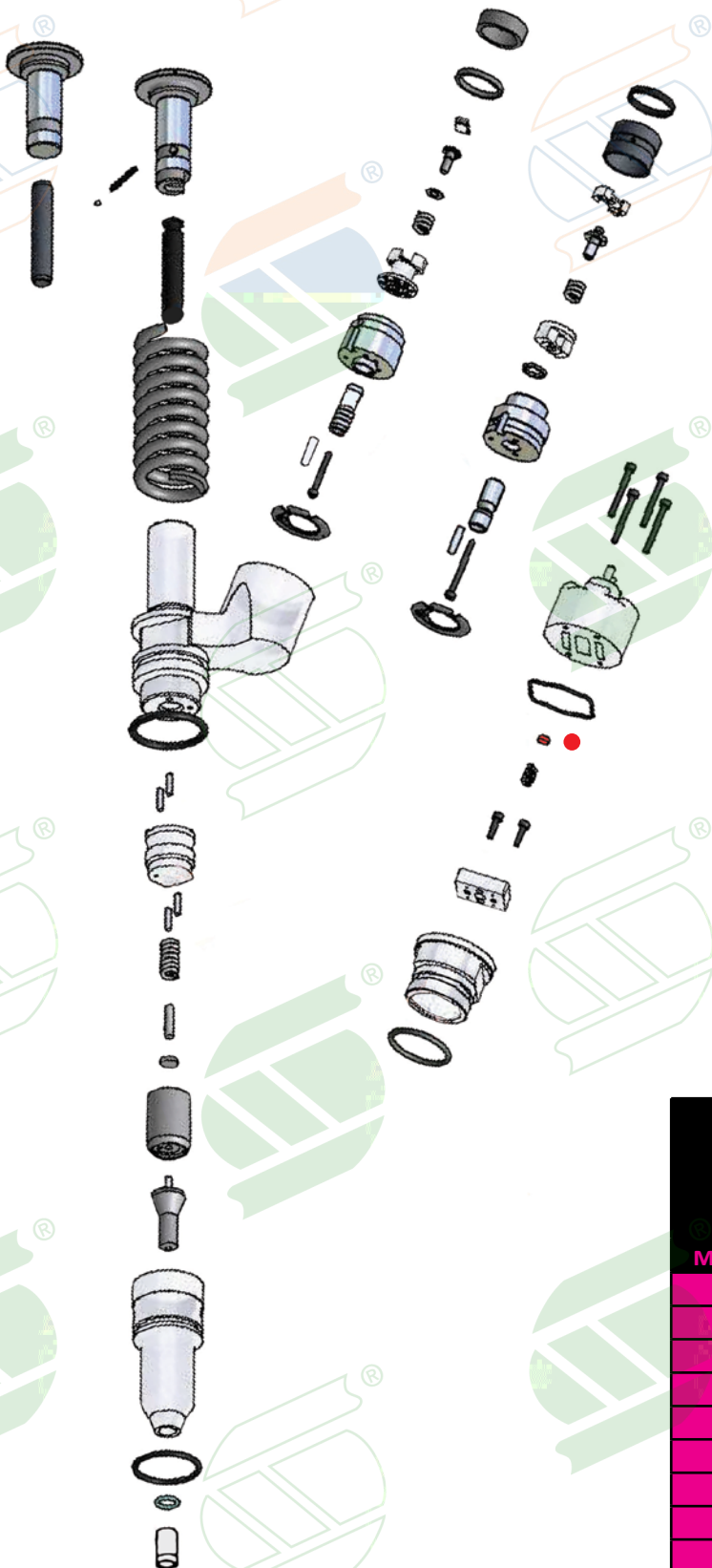

Ø7,8

da 2,20.. a 3,25
ALTRE MISURE DISPONIBILI A RICHIESTA
OTHER SIZES AVAILABLE UPON REQUEST
OTROS TAMAÑOS DISPONIBLES BAJO PETICIÓN
ДРУГИЕ РАЗМЕРЫ ДОСТУПНЫ ПО ЗАПРОСУ
根據要求提供其它尺寸

CODICE OMS	SPESORE	INCREMENTO	N° PEZZI
11-23-650	DA 2,20 A 3,25	0,05	220

HANDBAG | VALIGETTA 24 POSIZIONI | POSITION

CODICE SINGOLI SPESSORI CODE INDIVIDUAL THICKNESSES			
MISURA	COD. OMS	MISURA	COD. OMS
2,20	11-23-650/220	2,75	11-23-650/275
2,25	11-23-650/225	2,80	11-23-650/280
2,30	11-23-650/230	2,85	11-23-650/285
2,35	11-23-650/235	2,90	11-23-650/290
2,40	11-23-650/240	2,95	11-23-650/295
2,45	11-23-650/245	3,00	11-23-650/300
2,50	11-23-650/250	3,05	11-23-650/305
2,55	11-23-650/255	3,10	11-23-650/310
2,60	11-23-650/260	3,15	11-23-650/315
2,65	11-23-650/265	3,20	11-23-650/320
2,70	11-23-650/270	3,25	11-23-650/325



CATERPILLAR 3406 E

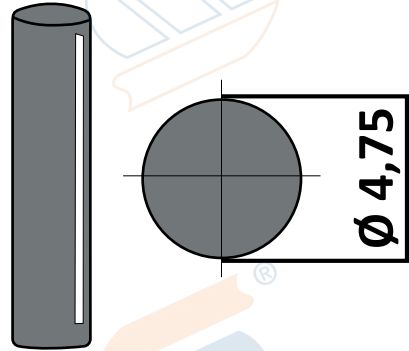
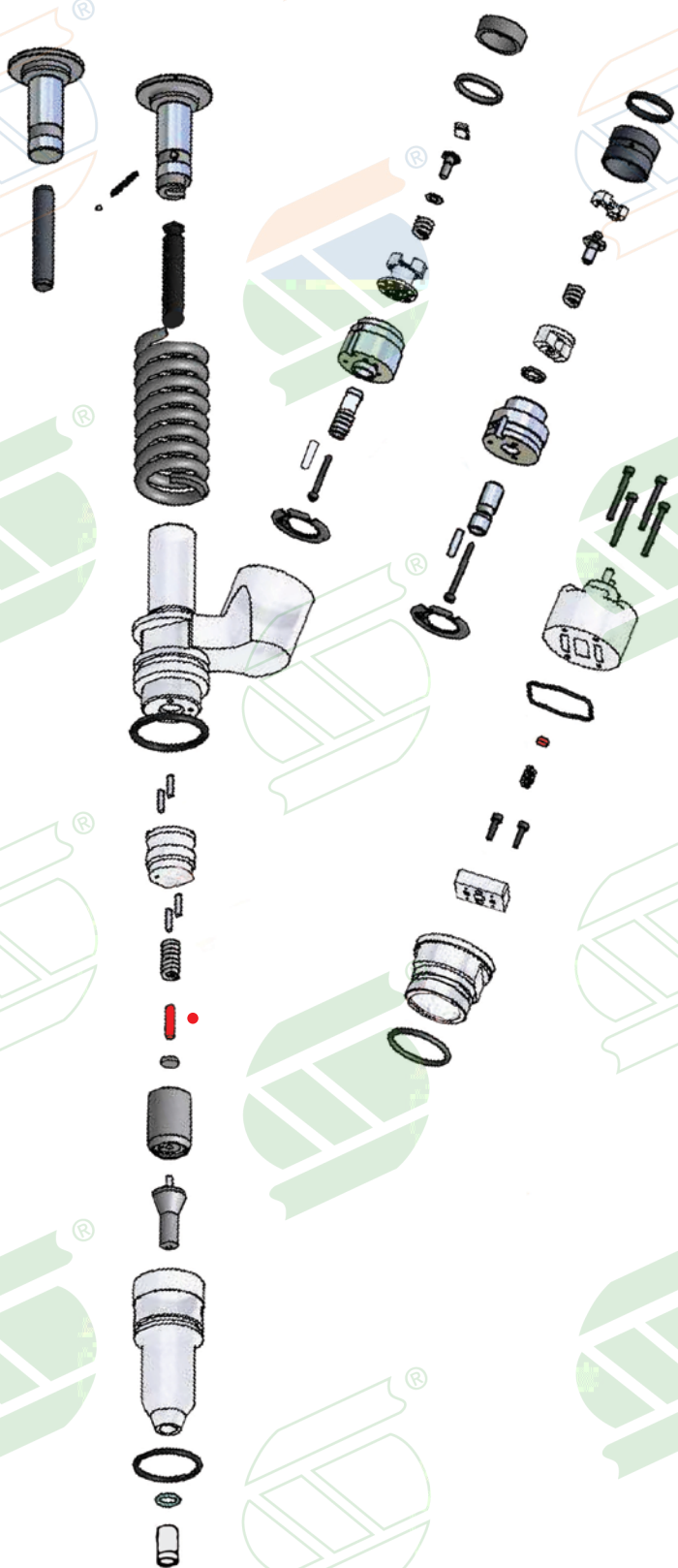

da 19,58.. a 19,84
 ALTRE MISURE DISPONIBILI A RICHIESTA
 OTHER SIZES AVAILABLE UPON REQUEST
 OTROS TAMAÑOS DISPONIBLES BAJO PETICIÓN
 ДРУГИЕ РАЗМЕРЫ ДОСТУПНЫ ПО ЗАПРОСУ
 根據要求提供其它尺寸

CODICE OMS	SPESORE	INCREMENTO	N° PEZZI
02-20-031	DA 19,58 A 19,98	0,02	210



CODICE SINGOLI SPessori CODE INDIVIDUAL THICKNESSES			
MISURA	COD. OMS	MISURA	COD. OMS
19,58	02-20-031/1958	19,78	02-20-031/1978
19,60	02-20-031/1960	19,80	02-20-031/1980
19,62	02-20-031/1962	19,82	02-20-031/1982
19,64	02-20-031/1964	19,84	02-20-031/1984
19,66	02-20-031/1966	19,86	02-20-031/1986
19,68	02-20-031/1968	19,88	02-20-031/1988
19,70	02-20-031/1970	19,90	02-20-031/1990
19,72	02-20-031/1972	19,92	02-20-031/1992
19,74	02-20-031/1974	19,94	02-20-031/1994
19,76	02-20-031/1976	19,96	02-20-031/1996
		19,98	02-20-031/1998



CATERPILLAR C6.6

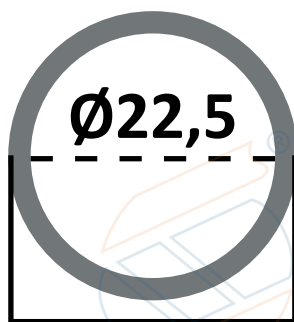

Ø26

da 2,04.. a 2,50
 ALTRE MISURE DISPONIBILI A RICHIESTA
 OTHER SIZES AVAILABLE UPON REQUEST
 OTROS TAMAÑOS DISPONIBLES BAJO PETICIÓN
 ДРУГИЕ РАЗМЕРЫ ДОСТУПНЫ ПО ЗАПРОСУ
 根據要求提供其它尺寸

CODICE OMS	SPESORE	INCREMENTO	N° PEZZI
11-23-839	DA 2,04 A 2,50	0,02	240



HANDBAG | VALIGETTA 24 POSIZIONI | POSITION

CODICE OMS	SPESORE	INCREMENTO	N° PEZZI
11-23-840	DA 2,04 A 2,50	0,01	470



HANDBAG | VALIGETTA 54 POSIZIONI | POSITION

CODICE SINGOLI SPessori CODE INDIVIDUAL THICKNESSES			
MISURA	COD. OMS	MISURA	COD. OMS
2,04	11-23-840/204	2,28	11-23-840/228
2,05	11-23-840/205	2,29	11-23-840/229
2,06	11-23-840/206	2,30	11-23-840/230
2,07	11-23-840/207	2,31	11-23-840/231
2,08	11-23-840/208	2,32	11-23-840/232
2,09	11-23-840/209	2,33	11-23-840/233
2,10	11-23-840/210	2,34	11-23-840/234
2,11	11-23-840/211	2,35	11-23-840/235
2,12	11-23-840/212	2,36	11-23-840/236
2,13	11-23-840/213	2,37	11-23-840/237
2,14	11-23-840/214	2,38	11-23-840/238
2,15	11-23-840/215	2,39	11-23-840/239
2,16	11-23-840/216	2,40	11-23-840/240
2,17	11-23-840/217	2,41	11-23-840/241
2,18	11-23-840/218	2,42	11-23-840/242
2,19	11-23-840/219	2,43	11-23-840/243
2,20	11-23-840/220	2,44	11-23-840/244
2,21	11-23-840/221	2,45	11-23-840/245
2,22	11-23-840/222	2,46	11-23-840/246
2,23	11-23-840/223	2,47	11-23-840/247
2,24	11-23-840/224	2,48	11-23-840/248
2,25	11-23-840/225	2,49	11-23-840/249
2,26	11-23-840/226	2,50	11-23-840/250
2,27	11-23-840/227		

CODICE SINGOLI SPessori CODE INDIVIDUAL THICKNESSES	
MISURA	COD. OMS
2,04	11-23-839/204
2,06	11-23-839/206
2,08	11-23-839/208
2,10	11-23-839/210
2,12	11-23-839/212
2,14	11-23-839/214
2,16	11-23-839/216
2,18	11-23-839/218
2,20	11-23-839/220
2,22	11-23-839/222
2,24	11-23-839/224
2,26	11-23-839/226
2,28	11-23-839/228
2,30	11-23-839/230
2,32	11-23-839/232
2,34	11-23-839/234
2,36	11-23-839/236
2,38	11-23-839/238
2,40	11-23-839/240
2,42	11-23-839/242
2,44	11-23-839/244
2,46	11-23-839/246
2,48	11-23-839/248
2,50	11-23-839/250



CATERPILLAR C6.6

da 1,30.. a 2,45

ALTRE MISURE DISPONIBILI A RICHIESTA

OTHER SIZES AVAILABLE UPON REQUEST

OTROS TAMAÑOS DISPONIBLES BAJO PETICIÓN

ДРУГИЕ РАЗМЕРЫ ДОСТУПНЫ ПО ЗАПРОСУ

根據要求提供其它尺寸

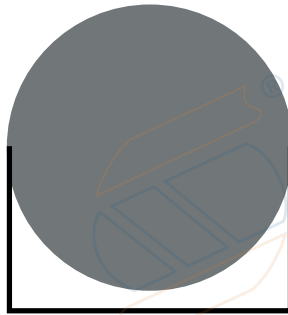

Ø6,6

CODICE OMS	SPESORE	INCREMENTO	N° PEZZI
11-23-841/1	DA 1,30 A 2,00	0,02	360
11-23-841	DA 2,00 A 2,35	0,01	360
11-23-842	DA 2,10 A 2,45	0,01	360



HANDBAG | VALIGETTA 36 POSIZIONI | POSITION

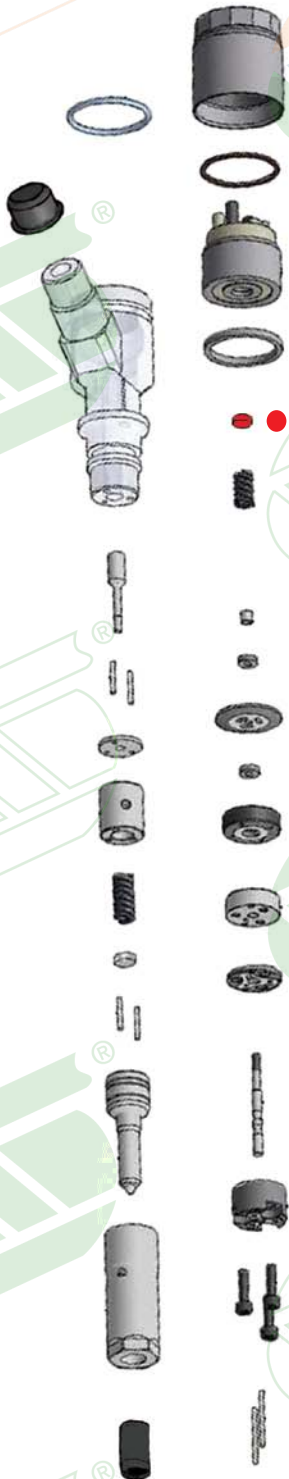

CODICE SINGOLI SPESSORI CODE INDIVIDUAL THICKNESSES

MISURA	COD. OMS	MISURA	COD. OMS
1,30	11-23-841/130	2,01	11-23-841/201
1,32	11-23-841/132	2,02	11-23-841/202
1,34	11-23-841/134	2,03	11-23-841/203
1,36	11-23-841/136	2,04	11-23-841/204
1,38	11-23-841/138	2,05	11-23-841/205
1,40	11-23-841/140	2,06	11-23-841/206
1,42	11-23-841/142	2,07	11-23-841/207
1,44	11-23-841/144	2,08	11-23-841/208
1,46	11-23-841/146	2,09	11-23-841/209
1,48	11-23-841/148	2,10	11-23-841/210
1,50	11-23-841/150	2,11	11-23-841/211
1,52	11-23-841/152	2,12	11-23-841/212
1,54	11-23-841/154	2,13	11-23-841/213
1,56	11-23-841/156	2,14	11-23-841/214
1,58	11-23-841/158	2,15	11-23-841/215
1,60	11-23-841/160	2,16	11-23-841/216
1,62	11-23-841/162	2,17	11-23-841/217
1,64	11-23-841/164	2,18	11-23-841/218
1,66	11-23-841/166	2,19	11-23-841/219
1,68	11-23-841/168	2,20	11-23-841/220
1,70	11-23-841/170	2,21	11-23-841/221
1,72	11-23-841/172	2,22	11-23-841/222
1,74	11-23-841/174	2,23	11-23-841/223
1,76	11-23-841/176	2,24	11-23-841/224
1,78	11-23-841/178	2,25	11-23-841/225
1,80	11-23-841/180	2,26	11-23-841/226
1,82	11-23-841/182	2,27	11-23-841/227
1,84	11-23-841/184	2,28	11-23-841/228
1,86	11-23-841/186	2,29	11-23-841/229
1,88	11-23-841/188	2,30	11-23-841/230
1,90	11-23-841/190	2,31	11-23-841/231
1,92	11-23-841/192	2,32	11-23-841/232
1,94	11-23-841/194	2,33	11-23-841/233
1,96	11-23-841/196	2,34	11-23-841/234
1,98	11-23-841/198	2,35	11-23-841/235
2,00	11-23-841/200		

CODICE SINGOLI SPESSORI CODE INDIVIDUAL THICKNESSES

MISURA	COD. OMS
2,10	11-23-842/210
2,11	11-23-842/211
2,12	11-23-842/212
2,13	11-23-842/213
2,14	11-23-842/214
2,15	11-23-842/215
2,16	11-23-842/216
2,17	11-23-842/217
2,18	11-23-842/218
2,19	11-23-842/219
2,20	11-23-842/220
2,21	11-23-842/221
2,22	11-23-842/222
2,23	11-23-842/223
2,24	11-23-842/224
2,25	11-23-842/225
2,26	11-23-842/226
2,27	11-23-842/227
2,28	11-23-842/228
2,29	11-23-842/229
2,30	11-23-842/230
2,31	11-23-842/231
2,32	11-23-842/232
2,33	11-23-842/233
2,34	11-23-842/234
2,35	11-23-842/235
2,36	11-23-842/236
2,37	11-23-842/237
2,38	11-23-842/238
2,39	11-23-842/239
2,40	11-23-842/240
2,41	11-23-842/241
2,42	11-23-842/242
2,43	11-23-842/243
2,44	11-23-842/244
2,45	11-23-842/245



CATERPILLAR 3126 HEUI

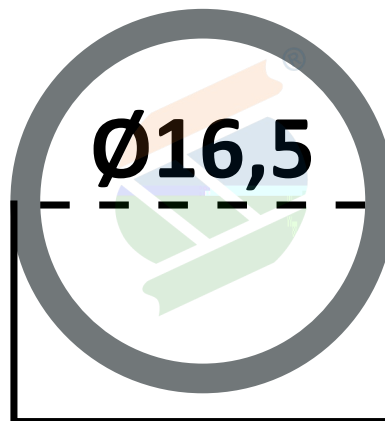
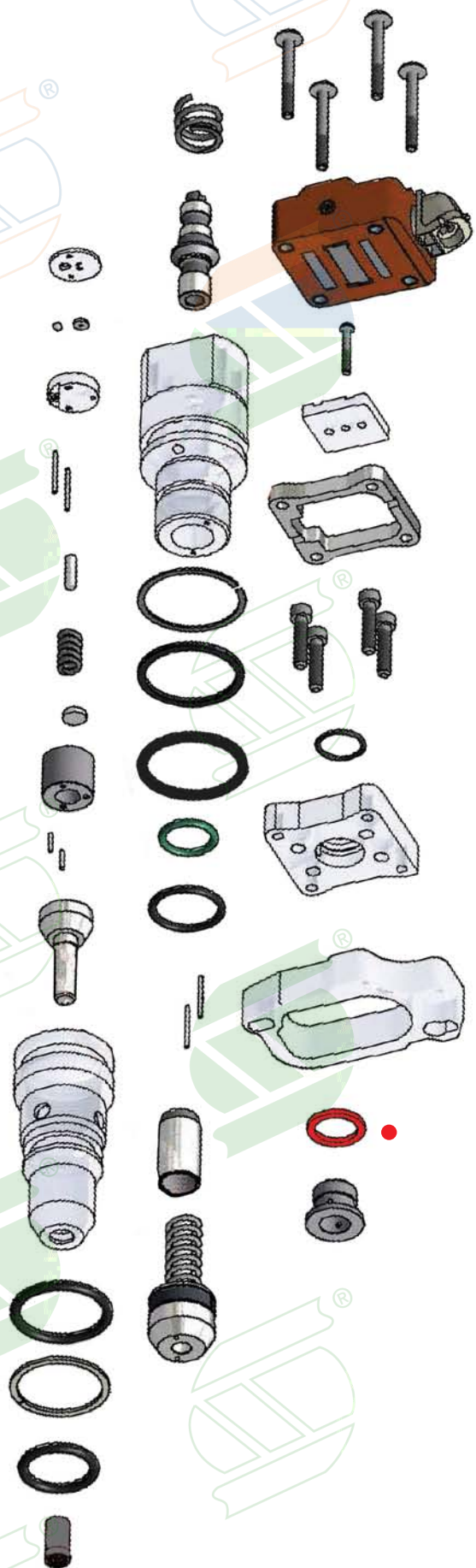

Ø21,8

da 2,00.. a 2,50

ALTRE MISURE DISPONIBILI A RICHIESTA

OTHER SIZES AVAILABLE UPON REQUEST

OTROS TAMAÑOS DISPONIBLES BAJO PETICIÓN

ДРУГИЕ РАЗМЕРЫ ДОСТУПНЫ ПО ЗАПРОСУ

根據要求提供其它尺寸

CODICE OMS	SPESSORE	INCREMENTO	N° PEZZI
11-23-961	DA 2,00 A 2,50	0,01	510



HANDBAG | VALIGETTA 54 POSIZIONI | POSITION



CATERPILLAR C7 HEUI

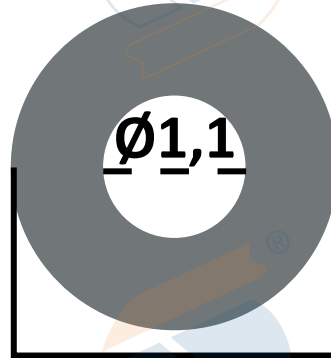

Ø6

da 1,00.. a 3,00

ALTRE MISURE DISPONIBILI A RICHIESTA

OTHER SIZES AVAILABLE UPON REQUEST

OTROS TAMAÑOS DISPONIBLES BAJO PETICIÓN

ДРУГИЕ РАЗМЕРЫ ДОСТУПНЫ ПО ЗАПРОСУ

根據要求提供其它尺寸

CODICE OMS	SPESORE	INCREMENTO	N° PEZZI
11-23-962	DA 1,00 A 3,00	0,10	210

HANDBAG | VALIGETTA 24 POSIZIONI | POSITION

CODICE OMS	SPESORE	INCREMENTO	N° PEZZI
11-23-963	DA 1,00 A 3,00	0,05	410

HANDBAG | VALIGETTA 54 POSIZIONI | POSITION



NEW

CATERPILLAR C7 / C9 HEUI

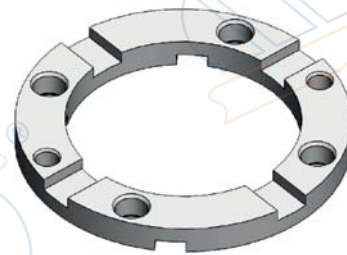

**Spessore Solenoide
Solenoid Spacer
Solenoide Espaciador**

da 2,84.. a 2,98

ALTRE MISURE DISPONIBILI A RICHIESTA
OTHER SIZES AVAILABLE UPON REQUEST
OTROS TAMAÑOS DISPONIBLES BAJO PETICIÓN
ДРУГИЕ РАЗМЕРЫ ДОСТУПНЫ ПО ЗАПРОСУ
根據要求提供其它尺寸



CODICE OMS	SPESSORE	INCREMENTO N° PEZZI
11-23-985	DA 2,84 A 2,98	0,02 40

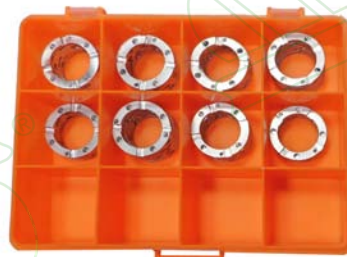

HANDBAG | VALIGETTA 12 POSIZIONI | POSITION

CODICE SINGOLI SPESSORI CODE INDIVIDUAL THICKNESSES

MISURA	COD. OMS
2,84	11-23-985/284
2,86	11-23-985/286
2,88	11-23-985/288
2,90	11-23-985/290
2,92	11-23-985/292
2,94	11-23-985/294
2,96	11-23-985/296
2,98	11-23-985/298

STRUMENTI DI MISURAZIONE

MEASURATION TOOLS

MICROMETRO DIGIMATIC IP65 METRICI

CODICE: 11-23-986

MICROMETRO AD ELEVATA ACCURATEZZA.
CON O SENZA USCITA DATI, OFFRE UNA
STRUTTURA AD ELEVATA RESISTENZA E UNA
PROTEZIONE IP 65.

ACCURATEZZA INCREDIBILE CON
 $\pm 1 \mu\text{m}$ DI ERRORE STRUMENTALE.

RISOLUZIONE:

0,001 MM

ERRORE STRUMENTALE:

$\pm 0,5 \mu\text{m}$

SCALA:

TAMBURO E BUSSOLA CROMATI
OPACHI, $\varnothing 18 \text{ MM}$

MASSA: 270



SUPPORTO PER MICROMETRI

CODICE: 11-23-987

- LASCIA LIBERE LE MANI PER L'USO DEL MICROMETRO
- CONTRIBUISCE A MISURE PIÙ STABILI E RIPETIBILI
- STUDIATO PER MISURE IN SERIE IN PRODUZIONE E CONTROLLO QUALITÀ

CAMPO MICROMETRO:

0-100 MM

NOTE:

INCLINAZIONE REGOLABILE

MASSA:

1210

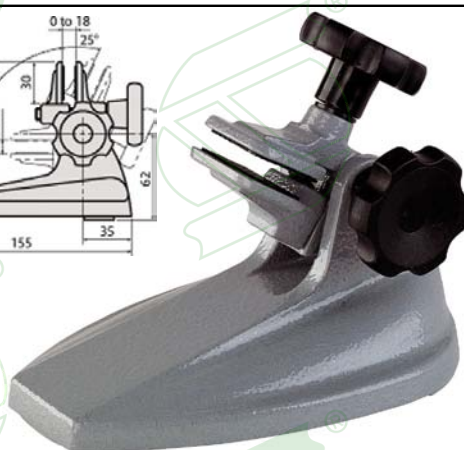
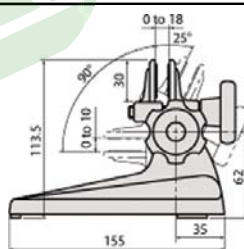

COMPARATORI ASSOLUTE DIGIMATIC CENTESIMALI

CODICE: 11-23-988

CODICE: 11-23-989

- SISTEMA ASSOLUTE: L'IMPOSTAZIONE DELLO ZERO AVVIENE UNA SOLA VOLTA E RIMANE MEMORIZZATA FINO ALLA SUCCESSIVA SOSTITUZIONE DELLE BATTERIE.
- PRECISIONE DI MISURA ANCHE ALLA MASSIMA VELOCITÀ
- DISPLAY A CARATTERI GRANDI DI FACILE LETTURA ED ELEVATA DURATA DELLE BATTERIE

11-23-988

11-23-989

CAMPO	12,7	CAMPO	25,4
RISOLUZIONE	0,01 MM	RISOLUZIONE	0,01 MM



STRUMENTI DI MISURAZIONE

MEASUREMENT TOOLS

COMPARATORI ABSOLUTE DIGIMATIC MILLESIMALI

- SISTEMA ABSOLUTE: L'IMPOSTAZIONE DELLO ZERO AVVIENE UNA SOLA VOLTA E RIMANE MEMORIZZATA FINO ALLA SUCCESSIVA SOSTITUZIONE DELLE BATTERIE.
- PRECISIONE DI MISURA ANCHE ALLA MASSIMA VELOCITÀ
- DISPLAY A CARATTERI GRANDI DI FACILE LETTURA ED ELEVATA DURATA DELLE BATTERIE

11-23-990		11-23-991	
CAMPO	12,7	CAMPO	25,4
RISOLUZIONE	0,001 MM	RISOLUZIONE	0,001 MM

CODICE: 11-23-990

CODICE: 11-23-991



BASE COMPARATORE IN GRANITO

- BASE PORTA COMPARATORE DI ALTA QUALITÀ PROGETTATA PER FORNIRE UN SUPPORTO STABILE E SICURO DURANTE LE MISURAZIONI. BASE IN GRANITO.

CODICE: BN003

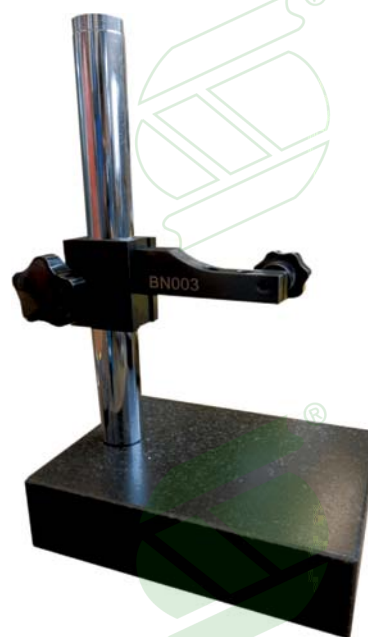

I NOSTRI CATALOGHI - CATALOGS

CATALOGO SPESSORI
CALIBRATION SHIMS
SUPLEMENTOS DE CALIBRACION
КАЛИБРОВКИ ПРОКЛАДКИ
校準墊片

OMS
COMMON RAIL & DIESEL INJECTION SPARE PARTS

VERSIONE 13.0

BOSCH
SIEMENS

DELPHI
NAVISTAR

DENSO
CATERPILLAR

CATALOGO RICAMBI
INIETTORI
INJECTOR DIESEL SPARE
PARTS CATALOG

OMS
COMMON RAIL & DIESEL INJECTION SPARE PARTS

VERSIONE 11.0

BOSCH
NAVISTAR

DELPHI
CATERPILLAR

DENSO
DETROIT DIESEL
& DODGE

SIEMENS
CUMMINS

VERSIONE 13.1 2016

OMS srl
COMMON RAIL & DIESEL INJECTION
SPARE PARTS

CATALOGO POMPE
PUMPS CATALOGUE

OMS srl
COMMON RAIL & DIESEL INJECTION
SPARE PARTS

CATALOGO KIT
KIT CATALOGUE

OMS
COMMON RAIL & DIESEL INJECTION SPARE PARTS
CATALOGO ATTREZZATURE
TOOLS CATALOGUE

VERSIONE 1.2

- CABLAGGI E SIMULATORI - WIRING AND SIMULATORS
 - ATTREZZATURA EQUIPMENTS - COMMON-RAIL
 - ATTREZZATURA BASE - EQUIPMENT BASE
 - ATTREZZATURA TURBO - TURBO EQUIPMENT
 - BLOCCHI TESTI - BECKOS
 - ATTREZZATURA POMPE - EQUIPMENT PUMPS
 - ATTREZZATURA POMPE IMMERSA - EQUIPMENT SUBMERGED PUMPS
 - RICAMBI - PARTS
 - CHIAVI - KEYS
 - ESTRATTORI - EXTRACTOR
 - GIUNTI - JOINT
 - FLANGE - FLANGES
 - MORSE - CLAMP
 - SUPPORTI BANCO PROVA - TEST BENCH SUPPORTS
 - STRUMENTI DI MISURA - MEASURING TOOLS
 - TUBI BANCO PROVA - TEST BENCH TUBES
 - E MOI...



**PUNTI VENDITA
RESELLERS**

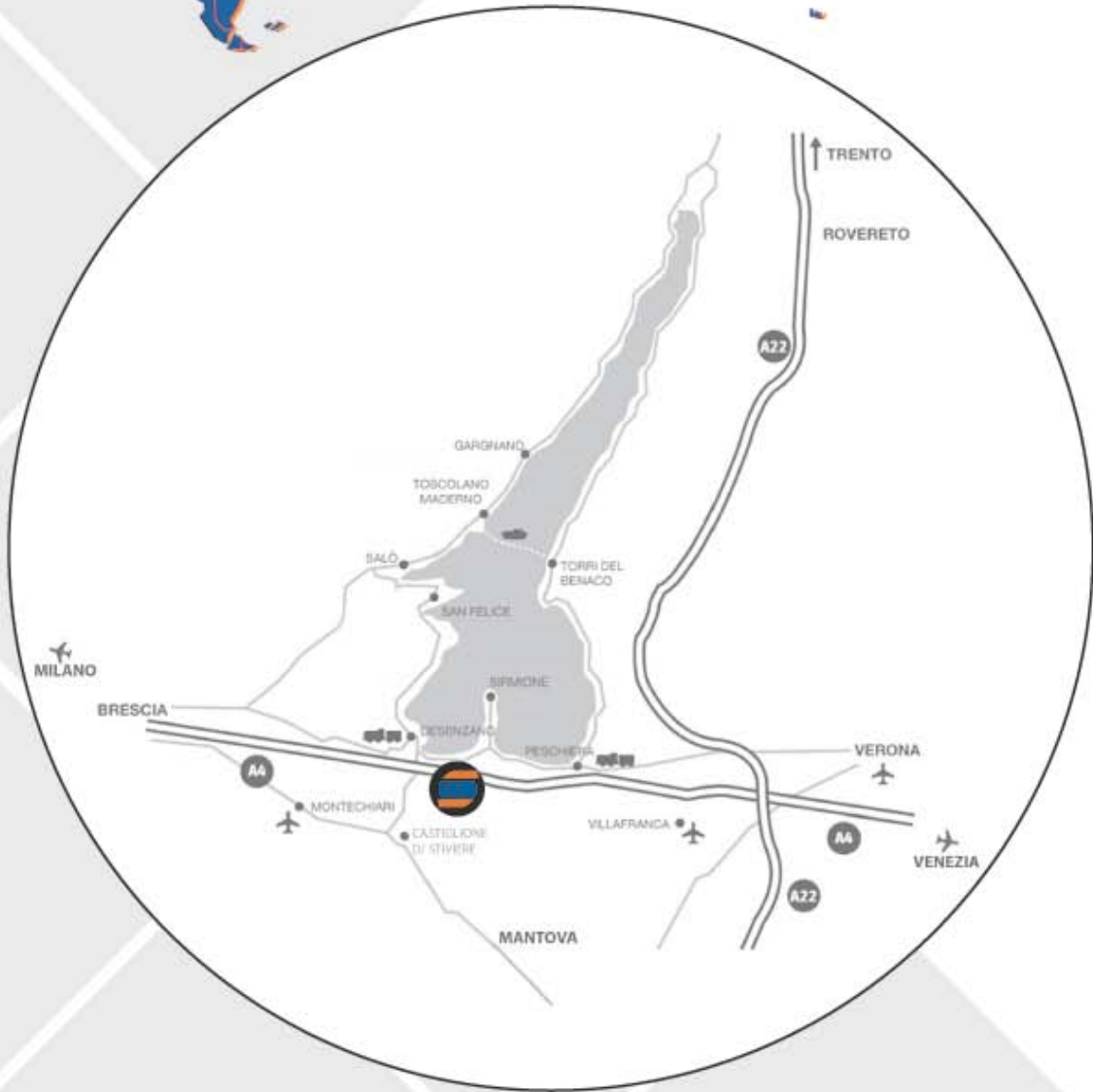

VIA PIAVE 15 (ZONA INDUSTRIALE) DESENZANO DEL GARDA (BS) ITALIA
TEL. +39 030 9127051 - FAX +39 030 9124070

OMS@OMSNET.IT WWW.OMSNET.IT

